



# **Falcon Player Manual**

**Version 5.4**  
**January 11, 2022**

**Written by Rick Harris**  
**Technical editor Mark Amber**

**This couldn't have been possible without the help and support of Chris Pinkham and Daniel Kulp answering my never ending questions.**

Version	Comments	Date Published
2.0	Updated to FPP 3.1 Release	August 22, 2019
2.1	Changed Wi Fi Tethering instructions	August 28, 2019
2.2	Update to FPP ver 3.6	February 21, 2020
4.2	Update to FPP ver 4.2 and change manual version to match FPP release version.	September 28, 2020
4.3	Update to ver 4.3	November 3, 2020
4.4	Update to ver 4.4	January 19, 2021
4.5	Update to ver 4.5.1	January 19, 2021
4.6	Update to ver 4.6.1	March 1, 2021
5.0 (draft)	Update for ver 5.0	August 5, 2021
5.0	Update to ver 5.0	August 7, 2021
5.4	Update to ver 5.4	January 9, 2022

# Introduction

The Falcon Player (FPP) is a lightweight, optimized, feature-rich sequence player designed to run on low-cost Single Board Computers (SBC). It was originally created to run on the \$35 Raspberry Pi, hence the middle 'P' in the short name but now the FPP supports many more systems. The FPP shorthand is still used but it is now just called Falcon Player. FPP is a software solution that you download and install on hardware which can be purchased from numerous sources around the internet. FPP aims to be controller agnostic, it can talk E1.31, DDP, DMX, Pixelnet, and Renard to hardware from multiple hardware vendors. This includes controller hardware from Falcon Christmas (<http://pixelcontroller.com>) and Kulp Lights (<http://kulplights.com>) as well as others.

Up until the end of the 2015 Christmas season, most users of FPP used the Raspberry Pi as the main player. Since then it has expanded with the BeagleBone series of SBCs being utilized as well.

The FPP can interface to a number of controllers. It can also play synchronized audio via an audio port /FM transmitter, synchronized video (via an HDMI), It supports USB devices and external interfaces via the GPIO bus. It can also drive pixels directly via the GPIO bus.

Many people use FPP as the main and only player by connecting it to one or more (E.131/DMX) controllers and run their light show sequences and audio off it. Others will use several FPPs operating in various modes to run their shows, play videos from a remote projector, control animatronics, or handle outside events that are all synched to the main (master) FPP.

The Raspberry Pi hardware running FPP software can be utilized with a cape to act as a controller to control a small matrix (36 P10 or 15 P5 panels) or 2 strings of pixels (approximately 1600 pixels per string at 20 fps, 800 pixels per string at 40 fps.)

The BeagleBone series SBCs have been extensively used with a cape to drive up to 96 P10 or 40 P5 panels (depending on the cape, a PocketBeagle only has 6 ports so can control 72 P10 or 30 P5 panels). The Beagle Bone series SBCs can also support other capes and act as a controller, such as the K4-PB, F8-B/K8-B, F16-B/K16A-B, F32-B/K32A-B, F8-PB/K8-PB, F40D-PB,K40D-PB, OctoPlus etc.

This manual covers the functional aspects of installing, configuring and operating FPP, the most popular show player for animated holiday lighting displays.

The current version of Falcon Player will run on the following hardware:

- Raspberry Pi 2 Model B
- Raspberry Pi 3 Model B
- Raspberry Pi 3 Model B+
- Raspberry Pi 3 Model A+
- Raspberry Pi 4 Model B
- Raspberry Pi Zero-W
- Raspberry Pi Zero (A micro USB hub might be needed)
- BeagleBone Black (Rev C)
- BeagleBone Black Wireless
- BeagleBone Green
- BeagleBone Green Wireless (not recommended if using any capes)

The philosophy of the FPP developers is to make the FPP as easy to install and use as possible, while still providing for much of the flexibility required by a diverse group of enthusiasts.

The FPP software is free to download and use and is provided by and supported by a number of volunteers.

Please refer to the Falcon Christmas website <https://FalconChristmas.com> for the latest news and discussions. In particular, the FPP forum page on the website is a great resource for help.

## **Acknowledgements**

The developers and authors of this software are volunteers. A very special thanks goes out to our families for supporting us in this hobby. Without their support we could not do this. If you find FPP useful please consider donating to help support future development of FPP. A DONATE button can be found on the Falcon Christmas website <https://FalconChristmas.com>

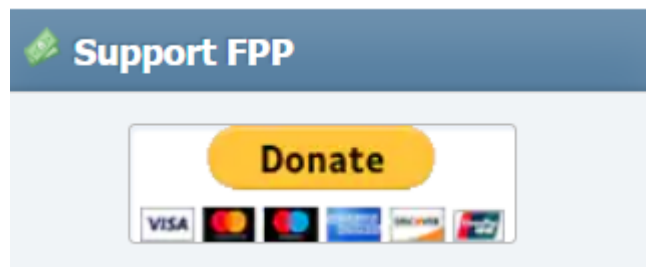

In 2021, FPP received a major overhaul, Dan Kulp, Chris Pinkham and Greg Hormann restructured most of the code to increase efficiency and make it easier for future development. About the same time three UI developers, Adam Coulombe, Andrew Ayton, and Justin J. Novack joined the team and completely overhauled the User Interface for better functionality and usability. Pat Delaney (the man with every device) was beneficial in the QA process.

# Table of Contents

<b>Introduction</b>	<b>2</b>
<b>Acknowledgements</b>	<b>3</b>
<b>Table of Contents</b>	<b>4</b>
<b>Hardware Needed</b>	<b>8</b>
Raspberry Pi	8
BeagleBone series (BB)	8
<b>FPP Quick Start Guide</b>	<b>9</b>
<b>Installing the FPP Software</b>	<b>9</b>
Required Programs	9
Getting the FPP software	9
Burning the Software Using Balena Etcher	11
Formatting the Micro SD (uSD) Card	11
Burning the Software Using dotNet Disk Imager	15
Formatting the Micro SD (uSD) Card	15
Software Installation	18
USB Tethering Installation	19
Network Connection Installation	20
Wi-Fi Tethering Installation	21
Initial Configuration	22
<b>Initial Network Configuration</b>	<b>26</b>
Wi-Fi Network settings	27
Ethernet Network Settings	28
Host & DNS Settings	29
<b>Final configurations</b>	<b>30</b>
Updating the Software	30
<b>General Overview</b>	<b>35</b>
<b>Program Settings and Navigation</b>	<b>35</b>
<b>Status/Control</b>	<b>39</b>
Status Page	39
Player Status Page	39
Remote Mode Status page	44
Channel Inputs Status Section	45
Network	45
Interface Settings	46
Host & DNS Settings	48



Tethering	49
Wi-Fi Tethering	49
USB Tethering	50
Interface Routing	51
MultiSync	51
FPP Settings	56
Playback	56
Audio/Video	57
Time	58
UI	59
User Interface	59
UI Colors	60
Email	62
MQTT	63
Privacy	64
Input/Output	65
Logging	65
Storage	67
System	67
Raspberry Pi System Page	68
BeagleBone System Page	68
Developer	70
FPP Backup	71
JSON Configuration Backup	71
Backup Configuration (creating a backup)	72
Restore Configuration	73
File Copy Backup	74
Proxy Settings	76
Command Presets	76
Creating an Command Preset to be Triggered in a Playlist	79
Creating a Command Preset to be Triggered in a Sequence.	81
Creating a Command Preset to be Triggered by a GPIO Button.	84
Effects	86
Display Testing	87
Channel Testing	87
RGB Test Patterns	88
Chase Patterns	88
Cycle Patterns	88
Solid Color Test Pattern	88
Single Channel Patterns	89
Sequence	90

<b>Content Setup</b>	<b>91</b>
File Manager	91
Playlists	92
Scheduler	96
Priority Scheduling	101
Script Repository Browser	101
Plugin Manager	102
Retrieve Plugin Info	102
Installed Plugins	102
Available Plugins	103
Template Plugin	104
Incompatible Plugins	104
<b>Input/Output Setup</b>	<b>105</b>
Channel Inputs	105
Adding E1.31/Artnet Inputs	106
Channel Outputs	107
E1.31/ ArtNet/ DDP/KiNet	109
Pixel Strings	111
Pi Based outputs	111
BeagleBone Based Outputs	112
Generic BeagleBone Outputs	112
Specific BeagleBone Outputs	113
LED Panels	114
Pi LED Panels Screen	115
BB LED Panels Screen	115
LED Panel Layout	116
Standard LED Panel Layout	117
Advanced Layout View	118
Other	119
Output Processors	119
Pixel Overlay Models	121
GPIO Inputs	122
<b>Help</b>	<b>124</b>
Version Info	125
Upgrade FPP	125
Upgrade from GitHub	125
Upgrade from another FPP	126
Upgrade from FPPOS	126
System Utilization	127
Player Stats	127
Disk Utilization	127

FPP Manual	128
Forums	128
Help Index	128
REST API Help	129
fpp & fppmm Usage	130
Credits	131
System Health Check	132
Troubleshooting Commands	132
SSH Shell	133
<b>Glossary</b>	<b>134</b>
<b>Advanced Options</b>	<b>137</b>
Network Considerations	137
Common Network Setups	137
Standalone	137
Wired on Home Network	138
Wired Separate Show Network	140
MultiSync/Remote	141
Virtual Matrix	143
Creating a Virtual Matrix	143
Playing Video	147
Virtual Display	148
HTTP Virtual Display	149
Common Plugins	151
Big Buttons	151
Matrix Tools	157
Message Queue Aggregator for Plugins	160
Message Queue to Matrix Overlay	162
Event Date	165
Weather Information	168
Projector Control	172
Plugin Development	172
<b>Resources</b>	<b>176</b>
Help	176
Configuring a Static Route	176
FPP Connect	178
GPIO Button Input	181
Network Overview	186
Universes, Channels and Ports, oh my!	187
<b>Troubleshooting</b>	<b>189</b>

# Hardware Needed

The Raspberry Pi and BeagleBone series SBC's have different requirements and setup instructions. Follow the instructions for your specific case. These instructions are the basics to get your device(s) running. Depending on your setup, you will need additional items after the initial setup to actually run your show (like power supply, network cables, wiring etc.)

## Raspberry Pi

Required Items:

- Supported Raspberry Pi
- Micro SD memory card. 4GB minimum, Class10 or better. 16GB or greater is recommended.(Samsung Evo Select and SanDisk Ultra are recommended)
- Power Supply for the Pi.
  - 5vdc 2.0A microUSB for the Pi Zero and Pi 2 series
  - 5vdc 2.5A microUSB for Pi 3 series
  - 5vdc 3.0A USB-C for Pi 4 series

Optional Items:

- Network cable (If you are connecting to your network via Ethernet or want to use the Network Configuration process)
- USB to Micro USB cable (for devices that support USB Tethering. USB Tethering is usually an easier process)
- Wi-Fi USB adapter if you're using a Pi that does not have built-in Wi-Fi (Edimax Nano is recommended (not the V2 version!) but it is best to stick with a 2.4Ghz only, some of the 5Ghz cards have compatibility issues)
- Cape installed if you are using one.

## BeagleBone series (BB)

It is recommended to use the Beaglebone Black, BeagleBone Green or PocketBeagle. The BeagleBone Green Wireless cannot be used with capes.

Required Items:

- Supported BeagleBone SBC
- Micro SD memory card. 4GB minimum, Class10 or better. 16GB or greater is recommended. (Samsung Evo Select and SanDisk Ultra are recommended)
- Appropriate power supply.
- **If you are using a PocketBeagle- A Wireless USB adapter or USB Ethernet adapter is required to complete your setup depending on how you are going to connect your FPP to your network.** (Edimax Nano is recommended but it is best to stick with a 2.4Ghz only, most of the 5Ghz cards have compatibility issues)

Optional Items:

- Network Cable (if you are connecting your FPP device to the network via Ethernet or want to use the Network Configuration process)
- USB Cable- If you want to install and configure the FPP device using the USB Tether method then you will need a USB to Mini USB cable (Micro USB if you are using a PocketBeagle or BeagleBone Green.) The USB Tethering method of installation is probably the easiest for the BeagleBone based devices.

- Octoscroller type Cape if connecting the BB to (P10/P5) Panels
- Other cape if you are using one.

## FPP Quick Start Guide

This section will give you the basic configurations to get you up and running but may not be the ultimate configuration that you will need to get your show up and running. Refer to the [Program Settings and Navigation](#) for more in depth explanations of each function/setting of FPP.

## Installing the FPP Software

### Required Programs

To install the software, you will need a couple programs, one for formatting the MicroSD card and one for “burning” the image.

**Note: You cannot just copy the files to the card!**

If you don't have programs to accomplish this, here are a couple suggestions:

An SD card formatter

<https://www.sdcard.org/downloads/index.html> has a version for both Mac and Windows.

<https://gparted.org/> has a version for Linux systems.

An image writer program

<https://www.balena.io/etcher/> has a version for Windows, Mac and Linux operating systems.

<https://sourceforge.net/projects/dotnetdiskimager/> is a good option for Windows users and has the ability to wipe the SD card so you won't need the SD Card Formatter..

There was a Step by Step instructional class presented at the Virtual Christmas Summit in July of 2020 that at the time of this manual is the most current method of installation and it is at <https://www.youtube.com/watch?v=ZV4o11XiaU0&t=108s>.

Canispater Christmas has some great tutorials with a nice sense of humor and he has one on how to install the FPP software at [https://youtu.be/X95Rv4JGG\\_Y](https://youtu.be/X95Rv4JGG_Y) and you can follow the instructions there if you like but the videos might be out of date.

Note: If this is the **first** time you are installing a version of FPP greater than 2.0 on a BeagleBone **Black** (not any other derivative) then you have to hold down the boot button as shown in the video on powering up. Some people miss this while watching the video.

If you don't know how you are going to use FPP in your network, you should refer to the [Common Network Setups](#) section of the manual.

## Getting the FPP software

You will then need to go to <https://github.com/FalconChristmas/fpp/releases> and download the **most current Image File**, not the source code for your application! The Image file has the **.img.zip** in the file name.

The Image Files are the files that start with FPP and they indicate the version and SBC image. Download the file that corresponds to the SBC you are using (Pi or BB). On the Github website there will be several releases listed. Not all of them have an image available. Scroll down until you find the first version with the images.

Note: you might have to expand the Assets section to see if an image is available.

Here is an example of the most current release as of August 2021 (pick the most current release for your application)

## Before expanding

Latest release

5.0

dkulp released this 2 hours ago · 1 commit to master since this release

### FPP 5.0

- [FPP 5.0](#)
- [Enhancements](#)
- [Major Changes/Incompatibilities](#)
- [Other updates/changes](#)
- [Upgrade Instructions](#)
- [Selecting an image](#)

### Enhancements

- Interface/"Look and Feel" Updates
  - The entire FPP UI has been completely re-written to be more "modern" and mobile friendly. We tried to keep it familiar to FPP users, yet "new and fresh".
  - New "Wizard" on first startup to help configure FPP for the first time
  - Troubleshooting page updated to run commands asynchronously and provide direct links to needed results.
  - Display testing page updated to provide easier adjustments to channel ranges and test settings
  - MultiSync Page updates to provide faster updates and much more information
  - New Privacy settings to prevent callouts to 3rd party sites for vendor logos, statistics, etc...
- Audio configured to use "dmix" when possible to allow simultaneous audio streams (ex: "Play Media" FPP command can play sound effects from GPIO triggers while show is running)
- Scheduler Enhancements:
  - Global disable of scheduler to easily disable all scheduled events

### Selecting an image

For Raspberry Pi series including Pi B, Pi B+, Pi 3, Pi 3+, Pi 4 and Pi Zero use this image

- [FPP-v5.0-Pi.img.zip](#)

For Beaglebone Black, Beaglebone Green, PocketBeagle, and Beaglebone Green Gateway use this image

- [FPP-v5.0-BBB.img.zip](#)

Assets 6

## After Expanding:



Assets 6	
BBB-5.0.fppos	557 MB
FPP-v5.0-BBB.img.zip	849 MB
FPP-v5.0-Pi.img.zip	892 MB
Pi-5.0.fppos	667 MB
Source code (zip)	
Source code (tar.gz)	

**Depending on your image-writing software, you may have to unzip the file before you can use it.**

Once you have downloaded the zip file for your application, you might have to extract the file first, depending on your imaging program. Then you have to burn the image onto the uSD card using the software for burning images. Make sure you are flashing the .img file and not the .zip file if your imaging software does not support imaging from a .zip file. If you are not sure, unzip the file first.

Installation methods will be explained using the 2 most popular methods, Balena Etcher and dotNet Disk Imager. Refer to the correct installation method for the software that you are using.

## Burning the Software Using Balena Etcher

If you are going to use dotNet Disk Imager to install the software, then skip to that section.

Note: Some people have reported errors when using Balena Etcher that were resolved by running Balena Etcher as an Administrator or setting the attributes of the image file to unblock depending on your computer system.

## Formatting the Micro SD (uSD) Card

Before you install the software onto the MicroSD (uSD) card, you have to format the SD card to remove any partitions that might exist on the card.

Insert the card into your computer and do a Quick Format using the SD Card Formatting software or other similar software (**Not Windows or MAC file managers**).

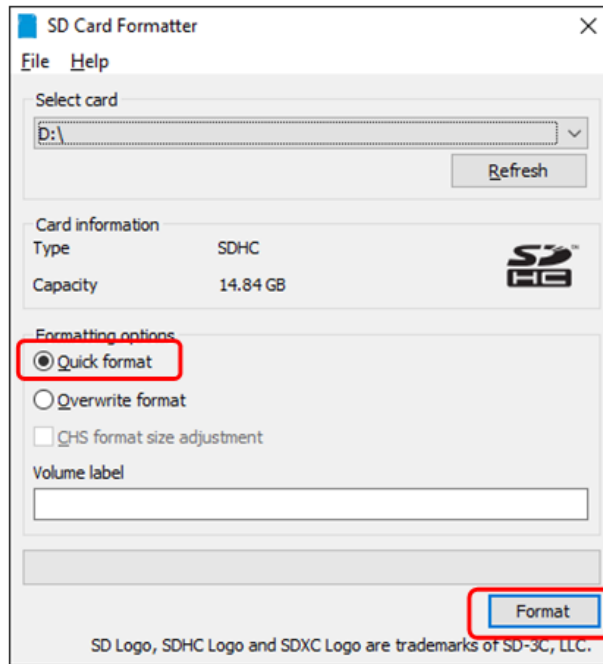

Open Balena Etcher.

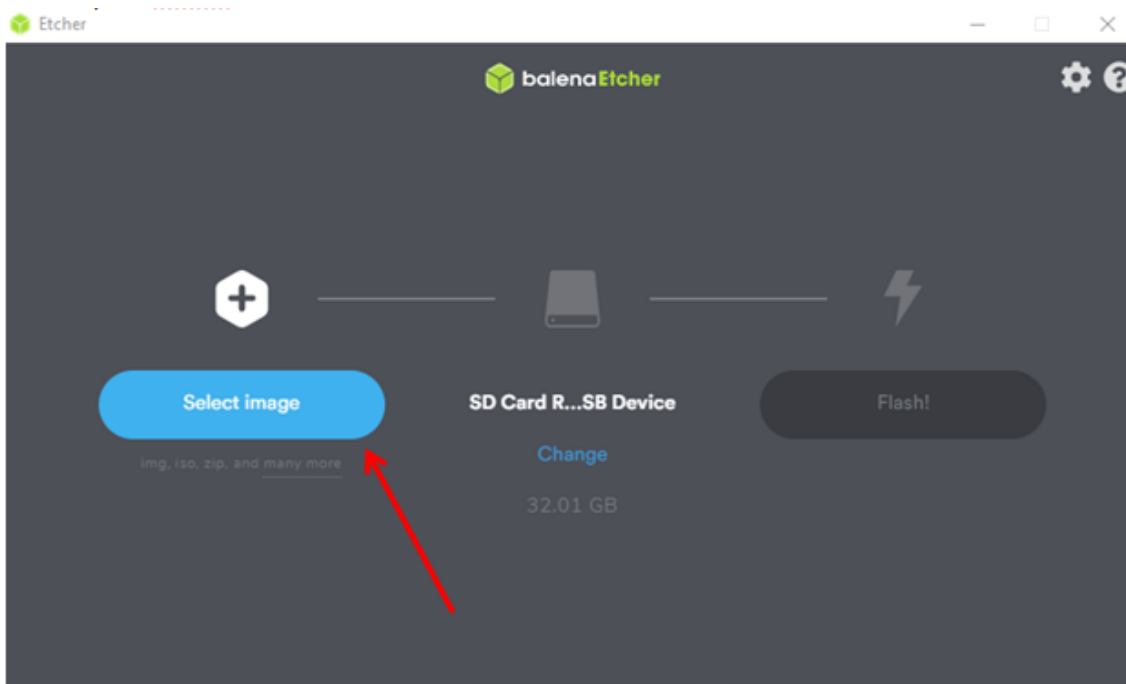

Click on the Select Image button and select the image file that you downloaded



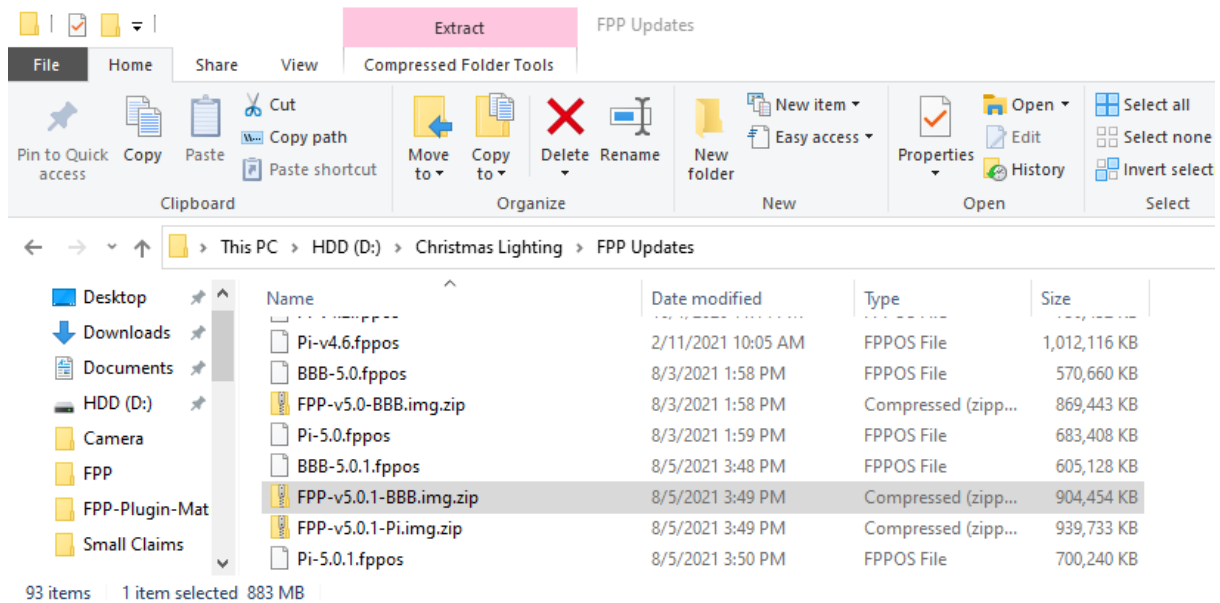

Make sure that the correct SD card is selected for the location

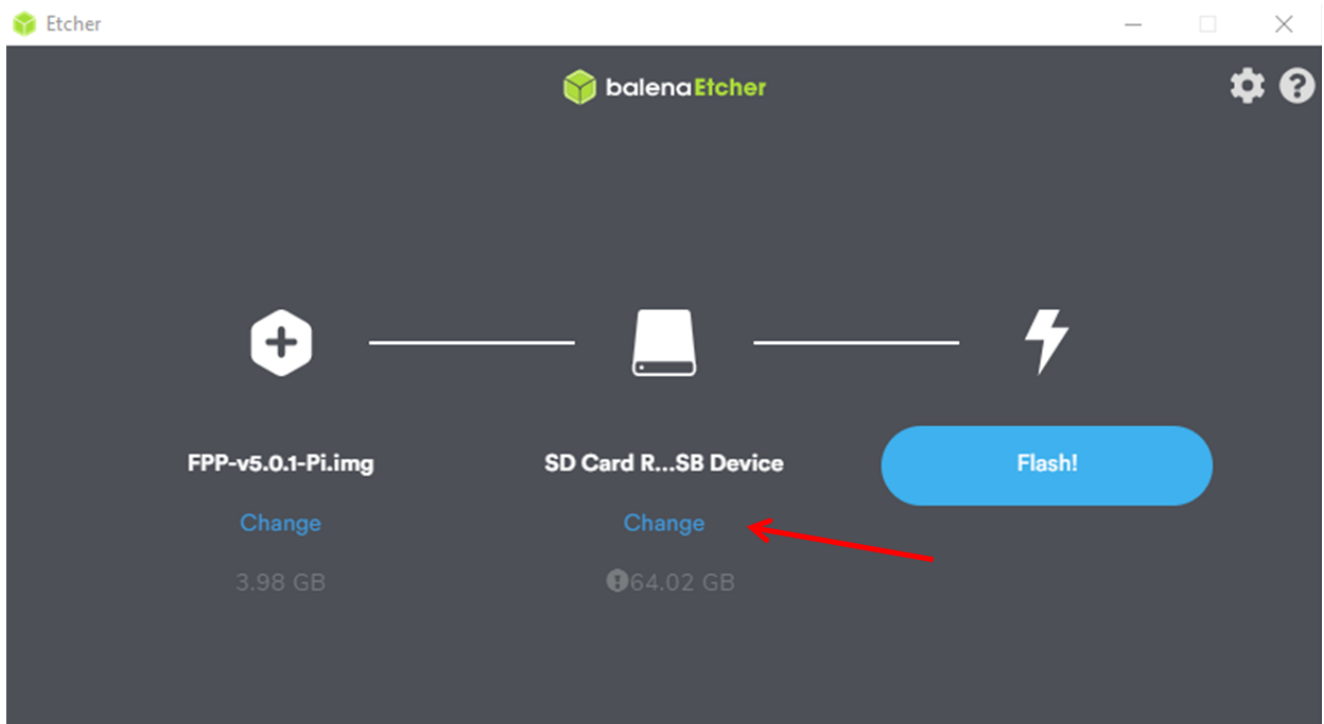

Click on the Flash! Button.

You might get a confirmation window. Click on Yes.

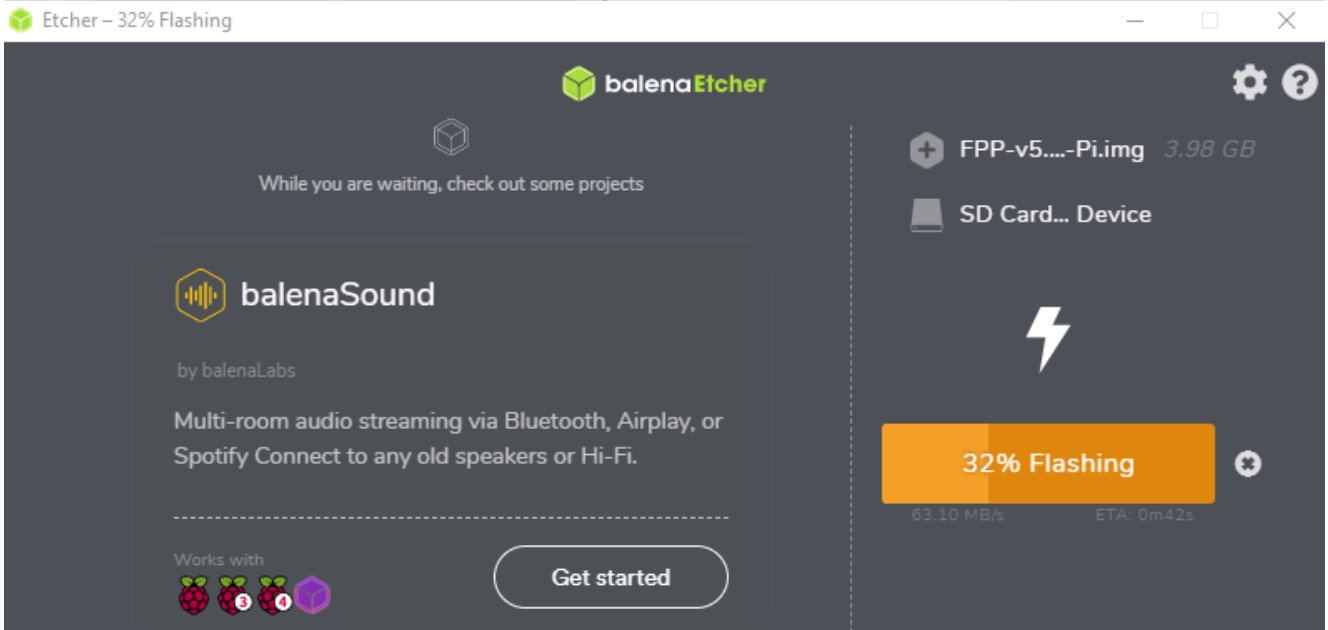

Balena Etcher will show the progress



When it is completed you will get the completion message.

The image that is burned onto the card is not in a format that Windows or Macs can read so you might get an error message after the image is burned. DO NOT perform the format process after you have loaded the image.

Once you have the image file on the uSD card, make sure your Pi or BB is turned off and insert the uSD card into your Pi/BB.

Proceed to the [Software Installation](#) section.

## Burning the Software Using dotNet Disk Imager

Open dotNet Disk Imager, you might get a confirmation message about allowing the program to make changes, click on Yes.

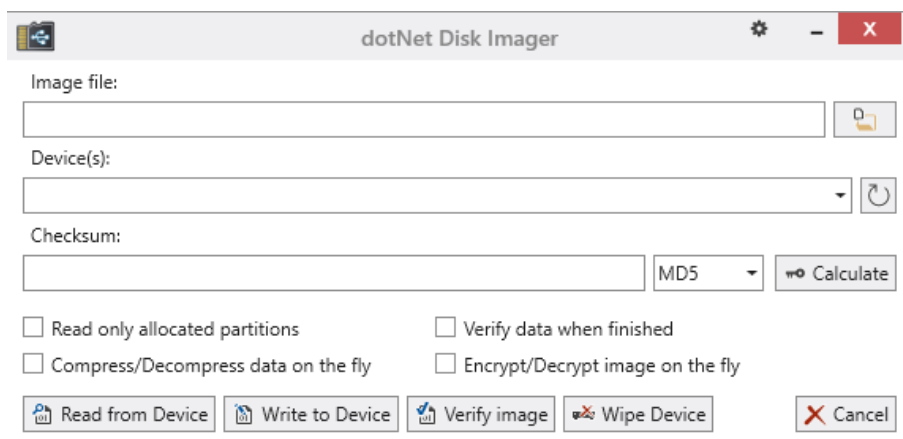

### Formatting the Micro SD (uSD) Card

Before you burn the software onto the MicroSD (uSD) card, you have to wipe the SD card to remove any partitions that might exist on the card.

Select your SD card in the Device section and then click the Wipe Device button.

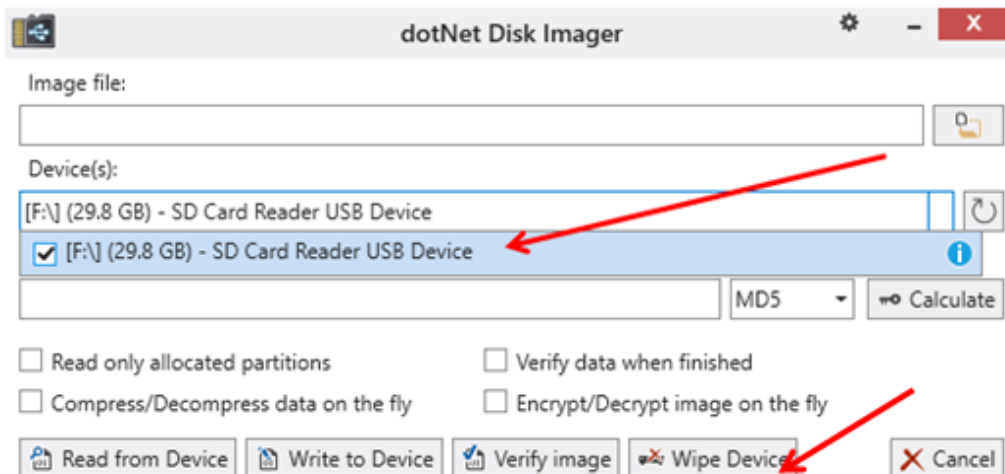

You might get a confirmation message, click on Yes

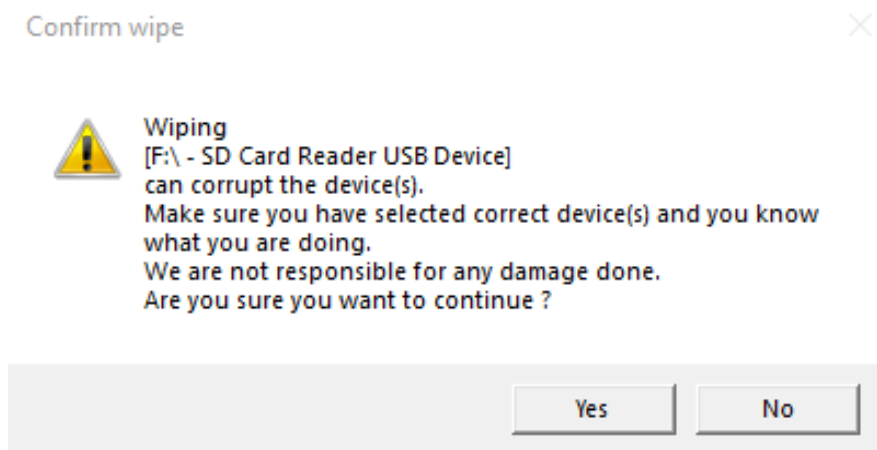

When complete, you will get a confirmation of the Wipe Process.

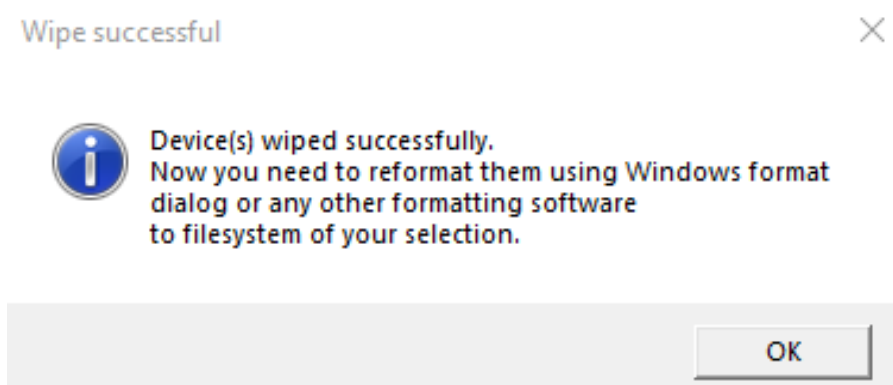

Select the image file that you downloaded for your device by clicking on the File icon to the right of the Image file input box.

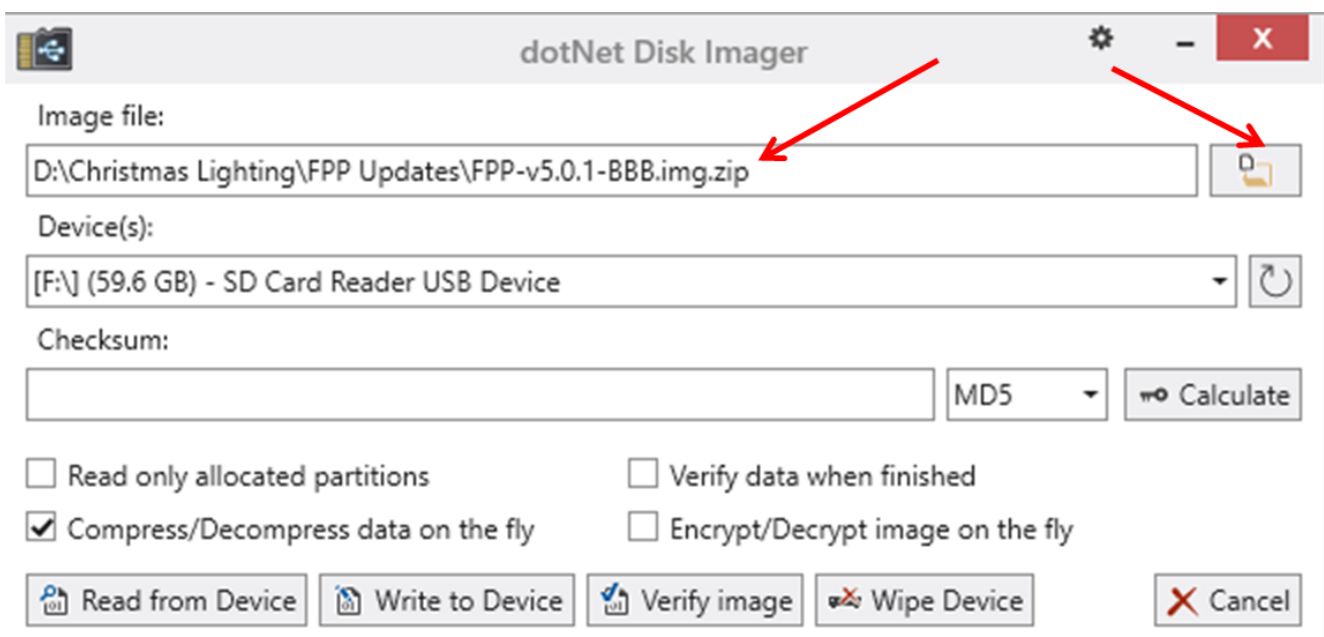

Click on the Write to Device button.

You might get a confirmation window. Click on Yes.

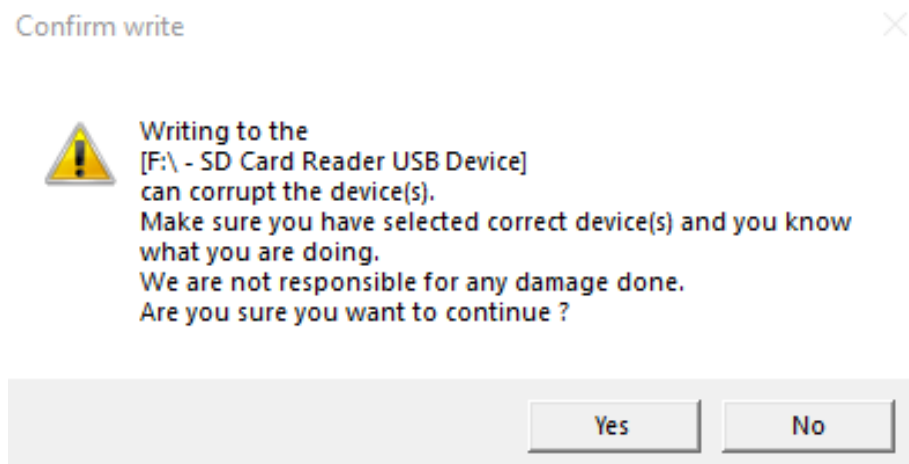

You will get a progress window.

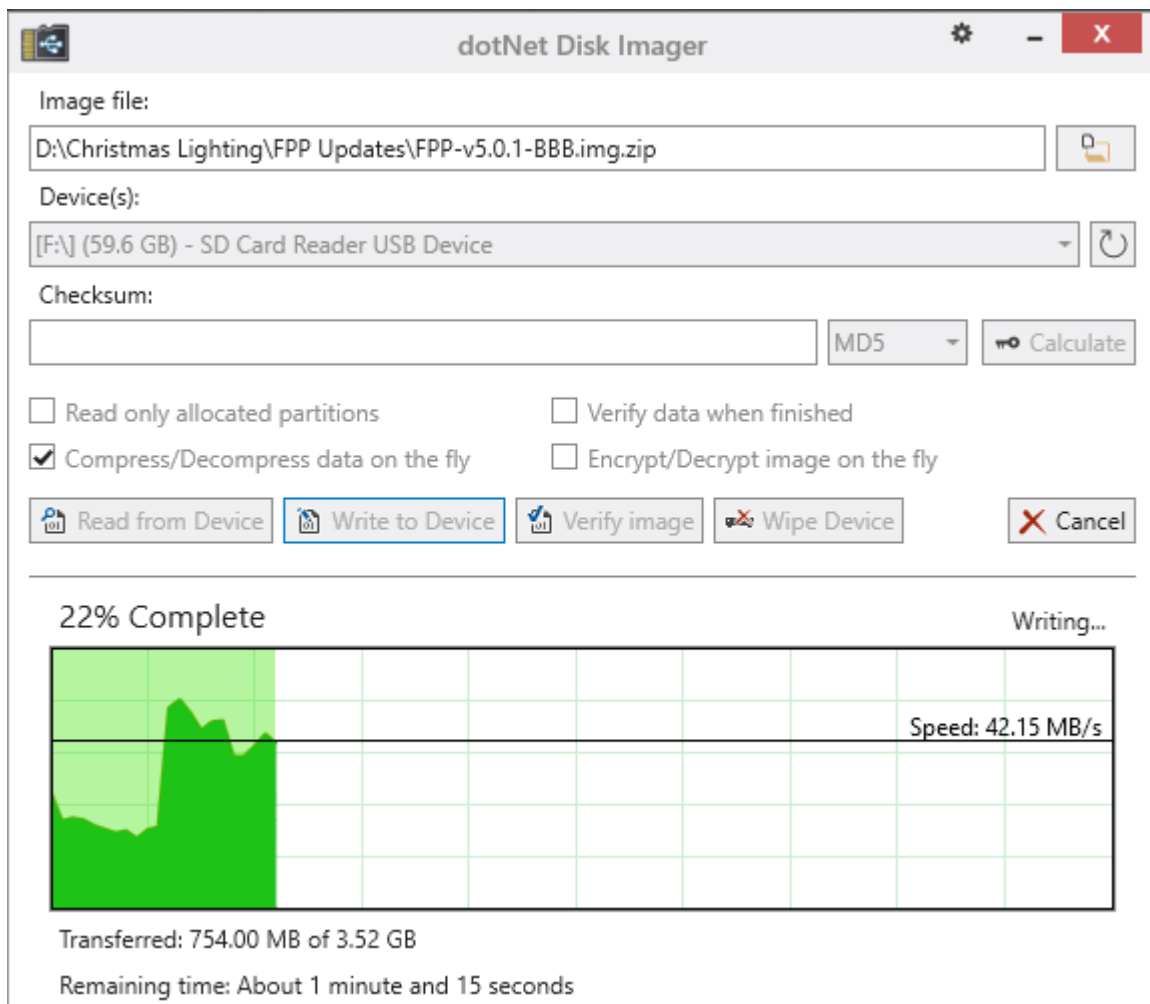

When it is completed you will get the completion message.

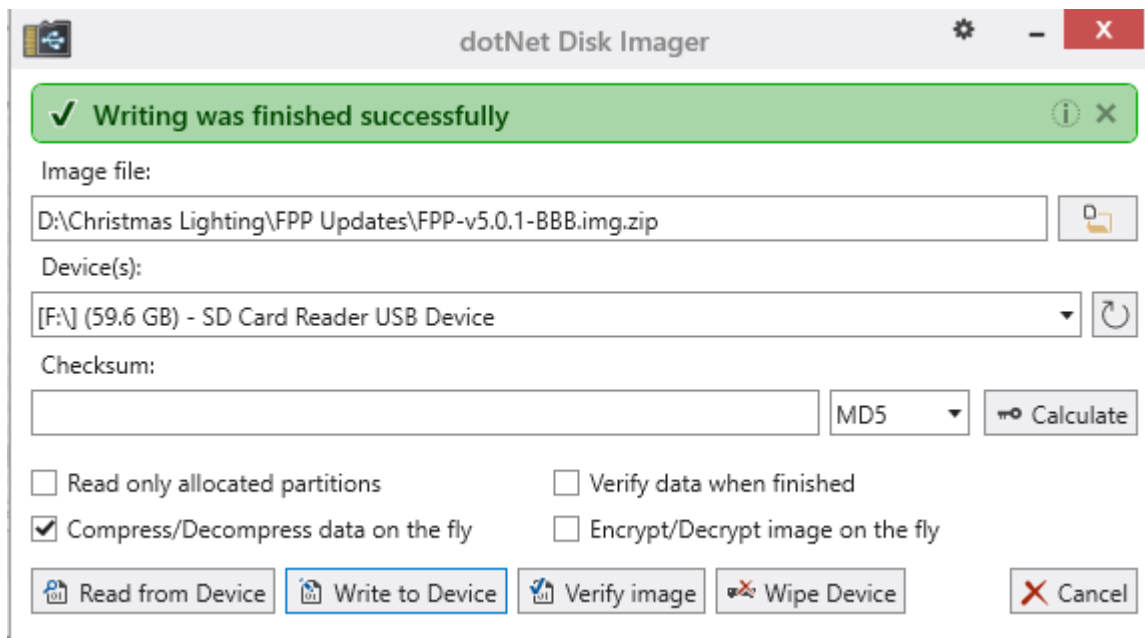

The image that is burned onto the card is not in a format that Windows or Macs can read so you might get an error message after the image is burned. DO NOT perform the format process after you have loaded the image.

Once you have the image file on the uSD card, make sure your Pi or BB is turned off and insert the uSD card into your Pi/BB.

## Software Installation

**FPP is configured from a Web based interface, you do not need to connect a monitor directly to the FPP**

You will access the FPP interface from your computer using a web browser.

**Note: Google Chrome is recommended. Internet Explorer and Microsoft Edge have problems displaying the interface correctly.**

Before you begin the software installation and configuration process, you should decide how you are ultimately going to have your FPP device connected to your network, either Wi-Fi, Ethernet, or in a few cases both. And then make sure that your FPP device has the appropriate connection or adapter installed prior to installing/configuring FPP. You also need to know what your home network router's IP address is (the 2 most common ones are 192.168.0.1 and 192.168.1.1 but there are many other common ones as well)

**Note: If your home router has an IP address with a subnet of 192.168.6.xxx, 192.168.7.xxx or 192.168.8.xxx then your FPP will have problems communicating in these environments. Those subnets are the default subnets used by Windows, Mac and Linux for USB tethering and could cause conflicts. You should change your home network to a different subnet to avoid problems.**

If you don't know how you are going to use FPP in your network, you should refer to the [Common Network Setups](#) section of the manual.

Due to the different configurations of each model of Pi and BeagleBone, the software installation is different and there can be more than one way to install the software. The following steps are a suggested method of installing the software on each model of SBC.

There are 3 basic ways of installing the software onto your FPP device and they are:

**USB Tethering-** USB Tethering is probably the easiest method to install and configure FPP. To install and configure FPP using USB Tethering, you will connect your computer directly to the FPP device with a USB cable. There are only a few devices that support USB Tethering.

The following devices can have the software installed and configured using USB Tethering:

- Raspberry Pi Zero W
- BeagleBone Black
- PocketBeagle
- BeagleBone Green
- BeagleBone Green Gateway

**Network Connection-** Installing and configuring the FPP software through a network connection can be accomplished almost as easily as the USB Tethering method. To install and configure your FPP device using a Network Connection requires you to connect your FPP device to your local network via a network cable. **(Not directly to your computer, that requires some advanced configuration)** If your FPP device does not have an Ethernet adapter, then you can usually install a USB to Ethernet adapter or choose another method to install and configure your FPP device.

Any of the Pis or BeagleBone SBCs can have the software installed and configured using the Network Connection method if they have an Ethernet connection or Ethernet adapter installed.

**Wi-Fi Tethering-** If you don't have a way to install and configure the FPP software through one of the more traditional methods, you can use the Wi-Fi tethering method on any FPP device that has Wi-Fi tethering capabilities, either on board or through a Wi-Fi adapter **(not all USB Wi-Fi adapters support Wi-Fi tethering.)**

## USB Tethering Installation

**Note: If the FPP device needs an adapter for a network connection that you are going to use for your network connection then make sure it is installed before you start your setup.** (Like a PocketBeagle that you are going to ultimately connect via Wi-Fi)

Note: Some capes will draw more current than a USB connection can provide, it is recommended to remove any capes before you connect the USB cable.

1. Make sure the uSD card with the proper image is inserted into the slot.
2. Make sure you have any network adapters that you will need for your network configuration.



3. Connect one end of the USB cable to your computer. (**Do not connect power from a power supply to the FPP device**)
4. If you are installing to a BeagleBone **Black** and it is the **first time** that an FPP version release 2.0 or higher is being installed, then press and hold the S2 button and plug in the USB cable. Hold the S2 button for 5 seconds after you connect the power supply. (Located near the uSD card.)

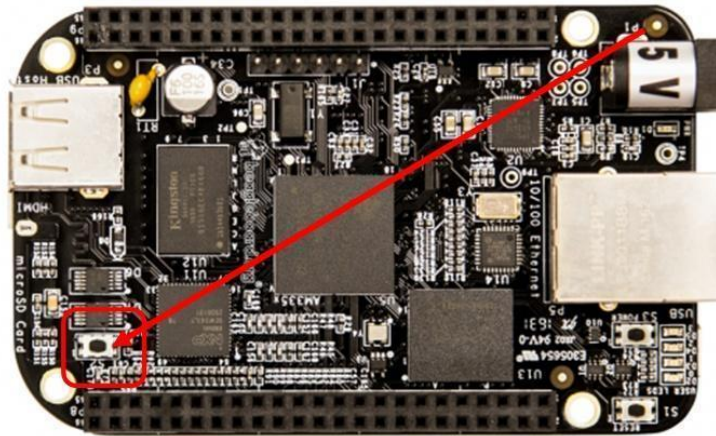

5. All other devices-plug the USB cable into the FPP device.

Note: The Raspberry Pi Zero has two places to connect a micro USB. One is for power only and one is for USB. Make sure you plug the USB cord into the USB Port.

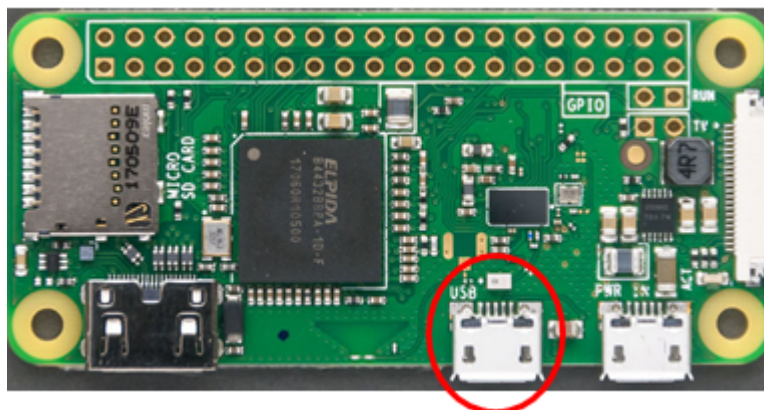

6. Wait approximately one minute (A Pi Zero might take slightly longer).
7. Open a web browser on your computer and if you are using a Windows computer, then enter 192.168.7.2 in the browser's address bar, if you are using a Mac or Linux computer then enter 192.168.6.2.
8. Continue to the [Initial Configuration](#) section of the manual to complete the setup.

## Network Connection Installation

Some capes have RJ45 ports but they are NOT Ethernet ports; they are used for DMX or Differential Receivers. They are not network connections and you cannot use these ports for initial setup.

**Note: If the FPP device needs an adapter for a network connection that you are going to use for your network connection, then make sure it is installed before you start your setup.** (Like a BeagleBone Black that you want to connect to your network via Wi-Fi)



1. Make sure the uSD card with the proper image is inserted into the slot.
2. Make sure you have any network adapters that you will need for your network configuration.
3. Connect the Raspberry Pi/BB to your router with the Ethernet cable.
4. If you are installing FPP to a BeagleBone **Black** and it is the **first time** that an FPP version release 2.0 or higher is being installed, then press and hold the S2 button and plug in the appropriate power supply. Hold the S2 button for 5 seconds after you connect the power supply. (Located near the uSD card.)

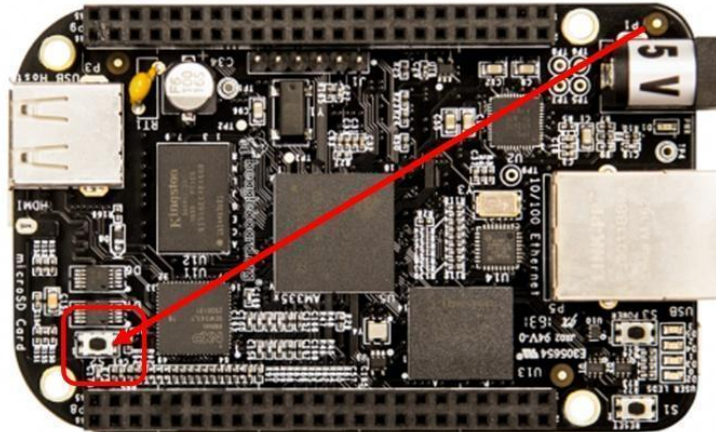

5. All other devices-connect the appropriate power to the device.
6. Wait approximately one minute (A Pi Zero might take slightly longer).
7. Enter <http://fpp> or <http://fpp.local/> in your browser. (If you are unable to connect to the FPP device using one of these addresses, go to the [Troubleshooting](#) section.)
8. Continue to the [Initial Configuration](#) section of the manual to complete the setup.

## Wi-Fi Tethering Installation

You can use Wi-Fi Tethering if your FPP device supports Wi-Fi Tethering. You can also use this method if your FPP Device cannot connect to your network so that you can make changes without having to erase the uSD card.

This will require using a computer with a wireless connection. Depending on your computer operating system, the method and screenshots will be slightly different.

1. Make sure the uSD card with the proper image is inserted into the slot.
2. Make sure you have any network adapters that you will need for your network configuration.  
**Note: Many Wi-Fi adapters do NOT support Wi-Fi tethering (on board Wi-Fi usually does) so if you installed a USB Wi-Fi adapter the Wi-Fi tethering might not work.**
3. If you are installing to a BeagleBone **Black** and it is the **first time** that an FPP version release 2.0 or higher is being installed, then press and hold the S2 button and plug in the appropriate power supply. Hold the S2 button for 5 seconds after you connect the power supply. (Located near the uSD card.)

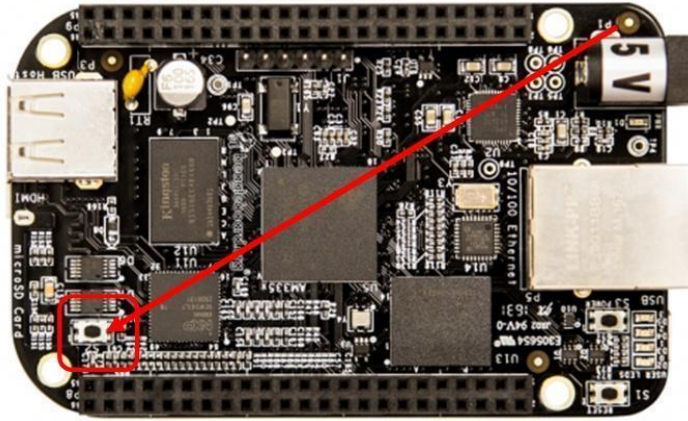

4. All other devices-connect the appropriate power to the device.
5. Wait approximately one minute (A Pi Zero might take slightly longer).
6. Go to your wireless networks on your computer and connect to the wireless network identified as FPP. The password is Christmas. (This process will vary depending on your operating system)
7. Type in 192.168.8.1 in your web browser to open the user interface.
8. Continue to the [Initial Configuration](#) section of the manual to complete the setup.

## Initial Configuration

Once the FPP has been installed on your Pi/BB, then you need to complete your setup.

Your screen will look similar to these. The logo on the right will indicate the type of SBC that is being used.

### Beaglebone Device

SD card has unused space. Go to [Storage Settings](#) to expand the file system or create a new storage partition.

**Initial Setup** Skip Initial Setup Finish Setup

FPP Player Mode:  ?

Host Name:  ?

Host description:  ?

Share Statistics:  ?

Fetch cape logos from vendors:  ?

Send cape serial numbers to vendors:  ?

Locale:  ?

Time Zone:  ?

Latitude:  ?

Longitude:  ?

Preview Statistics Lookup Time Zone Lookup Location Show On Map

# Raspberry Pi Device

FPP v5.0

SD card has unused space. Go to [Storage Settings](#) to expand the file system or create a new storage partition.

### Initial Setup

[Skip Initial Setup](#) [Finish Setup](#)

FPP Player Mode:  ?

Host Name:  ?

Host description:  ?

Share Statistics:  ?

Fetch cape logos from vendors:  ?

Send cape serial numbers to vendors:  ?

Locale:  ?

Time Zone:  ?

Latitude:  ?

Longitude:  ?

[Preview Statistics](#) [Lookup Time Zone](#) [Lookup Location](#) [Show On Map](#)

Click on the Storage Settings link that is in the red banner.

FPP Initial Setup

Status/Control Content Setup Input/Output Setup Help

SD card has unused space. Go to [Storage Settings](#) to expand the file system or create a new storage partition.

### Initial Setup

[Skip Initial Setup](#) [Finish Setup](#)

FPP Player Mode:  ?

Host Name:  ?

Host description:  ?

Share Statistics:  ?

Click on the Grow Filesystem button.

FPP Settings

Status/Control Content Setup Input/Output Setup Help

Playback Audio/Video Time UI Email MQTT Logging **Storage** System Developer

Storage Device:

Changing the storage device to anything other than the SD card is strongly discouraged. There are all kinds of problems that using USB storage introduce into the system which can easily result in various problems include network lag, packet drops, audio clicks/pops, high CPU usage, etc... Using USB storage also results in longer bootup time. In addition, many advanced features and various capes/hats are known to NOT work when using USB storage.

In addition to the above, since it is not recommended, using USB storage is not tested nearly as extensively by the FPP developers. Thus, upgrades (even "patch" upgrades) have a higher risk of unexpected problems. By selecting a USB storage device, you assume much higher risk of problems and issues than when selecting an SD partition.

**SD Card Actions:**

[Grow Filesystem](#) This will grow the file system on the SD card to use the entire size of the SD card.

This should bring you to this screen, click on Yes:

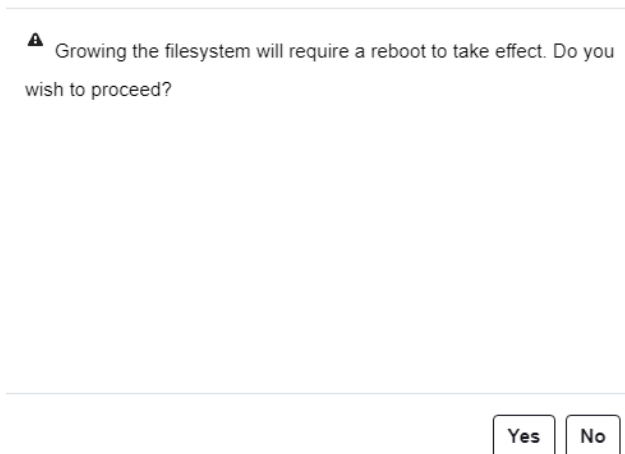

You should get to a screen similar to this, click on the Close button

### Storage Expand

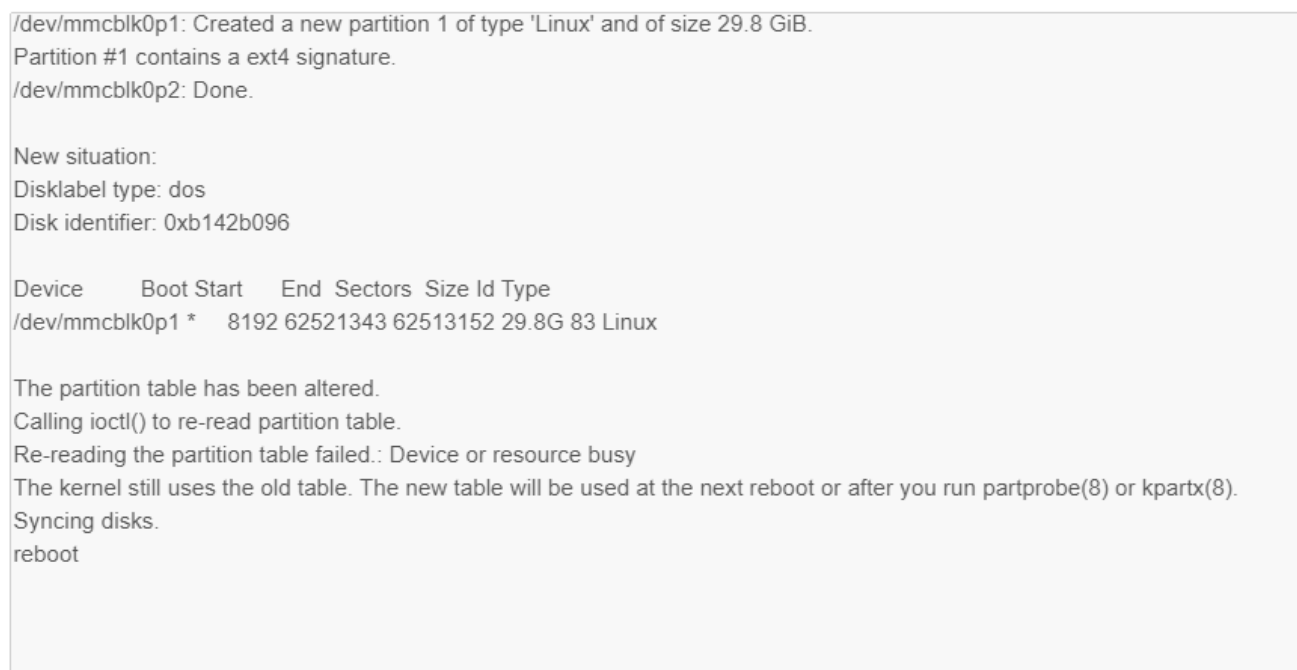

When you get back to the main screen, you will get a reboot warning, **do not reboot** at this time.

Navigate back to the Status Page

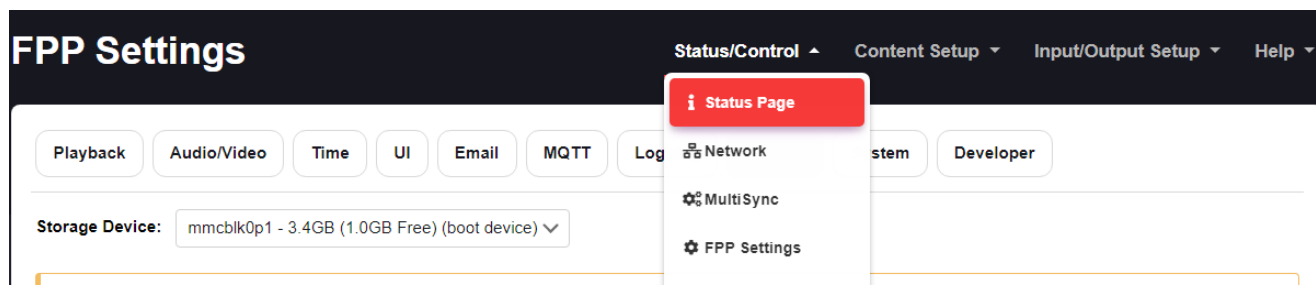

On the Status Page you will get the Initial Setup page:

## Initial Setup

Skip Initial Setup

Finish Setup

1	FPP Player Mode	Player	?
2	Host Name	FPP	?
3	Host description		?
4	Share Statistics	Banner	?
5	Fetch cape logos from vendors	<input checked="" type="checkbox"/>	?
6	Send cape serial numbers to vendors	<input type="checkbox"/>	?
7	Locale	Global	?
8	Time Zone	Europe/London	?
9	Latitude	38.938524	?
10	Longitude	-104.600945	?

1. FPP Player Mode- Set this to the mode that this FPP device will be running. If you are not sure, leave it at the default of Player(refer to [FPP Mode](#) for more information.)
2. Host Name- Create a meaningful name for this FPP Device (refer to [Host & DNS Settings](#) for more information.)
3. Host description- You can enter additional information about your device if you want (refer to [Host & DNS Settings](#) for more information.)
4. Share Statistics- Select the method that you want anonymous statistics shared with the development team. Enabled is the suggested setting (refer to [Privacy](#) for more information.)
5. Fetch cape logos from vendors- Vendors can put a logo on the screen, you can disable this but it is not usually necessary.
6. Send cape serial numbers to vendors-Vendors can send the serial number of your device to them. Enabling this will send this information.
7. Locale- The locale setting is used to configure some region specific settings such as Holidays to be used in the Scheduler.
8. Time Zone- Select your Time zone for accurate scheduling times. You can use the Lookup Time Zone button at the bottom that will usually identify the correct time zone.
9. Latitude- If you want to use the Sunrise or Sunset scheduling features, then your location has to be accurately configured. You can use the Lookup Location button at the bottom and it will usually identify the correct location. You can verify it with the Show On Map button at the bottom.
10. Longitude- If you want to use the Sunrise or Sunset scheduling features, then your location has to be accurately configured. You can use the Lookup Location button at the bottom and it will usually identify the correct location. You can verify it with the Show On Map button at the bottom.

Preview Statistics- This will show you what statistics will be sent to the development team.

Once you have completed the Initial Setup, click on the Finish Setup button in the upper right section of the page.

# Initial Network Configuration

You should have decided how you want your network configured before you edit your network settings. If you are not sure, then refer to the [Common Network Setups](#) section of the manual for more information. If you want a temporary network configuration you can use the [Wired on Home Network](#) configuration so that you can update the software and make final configurations before using FPP in your final network configuration. This would be a good configuration for testing purposes as well. But if your FPP device doesn't have an Ethernet port but has a Wi-Fi adapter then [Wired Separate Show Network](#) might be a better option.

Click on the Status/Control and then Network tab.

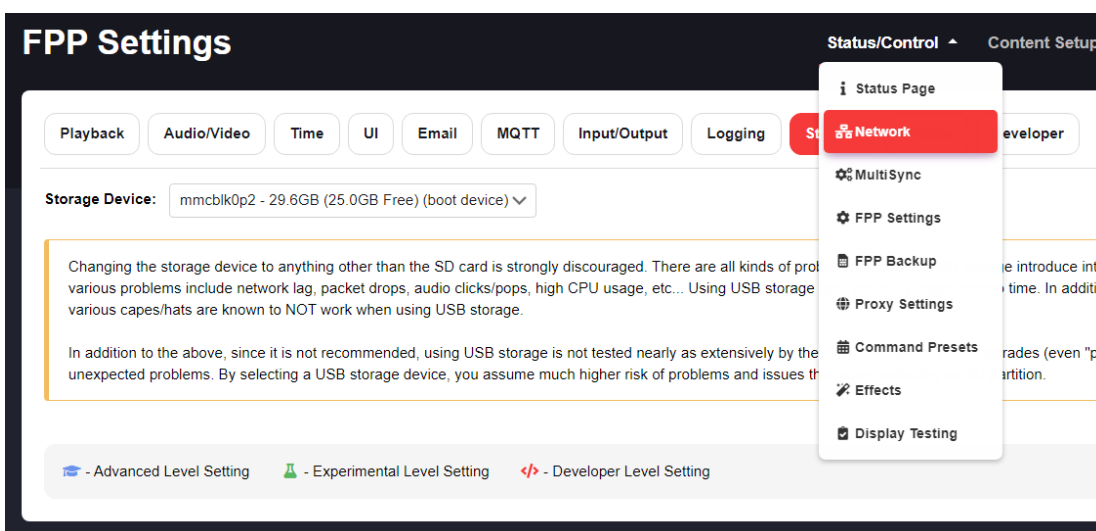

You should have a screen similar to this:

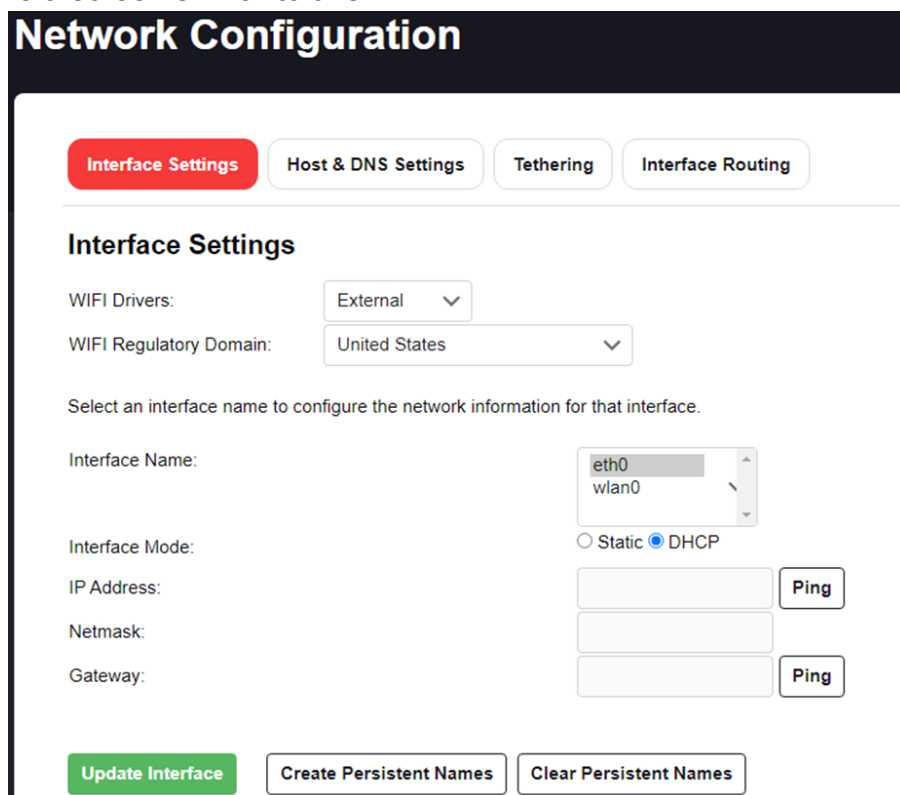



# Wi-Fi Network settings

If you do not need to configure a Wi-Fi connection, then skip to the [Ethernet Network Settings](#) section.

**Note: Many USB Wi-Fi adapters do not support 5 GHz.**

## Interface Settings

1 WiFi Drivers: External

2 WiFi Regulatory Domain: United States

Select an interface name to configure the network information for that interface.

Interface Name: 3 eth0  
wlan0

Interface Mode: 4  Static  DHCP

IP Address: 5 192.168.1.250 Ping

Netmask: 6 255.255.255.0

Gateway: 7 192.168.1.1 Ping

**Wireless Settings:**

WPA SSID: 8 YourNetworkID Hidden

WPA Pre Shared key (PSK): 9 ..... Show

**Update Interface** **Create Persistent Names** **Clear Persistent Names**

1. Normally the External Wi-Fi drivers work best so keep that setting.
2. Select the country you will be using your FPP device.
3. Click on the wlan0 interface (wlan0 is the wireless interface)
4. Select Static if you want to assign the IP address yourself, select DHCP if you want your router to assign the IP address. (refer to [Network Considerations](#) for more information.)  
Note: If you use DHCP, then the Host Name and DNS server is important to be configured correctly.
5. If you selected the Static option, enter your IP address, this address must be unique to this device interface.
6. The Netmask for most consumer networks is 255.255.255.0 (it should be the same as your show or home network router.
7. The Gateway will be the IP address of your home or show router and will usually get filled in, but make sure it is correct.

8. Enter your WPA SSID. It must be spelled exactly as it is configured in your router including the capitalization!
9. The WPA Pre Shared key (PSK) is the password for your wireless network. You can either show or hide your password by clicking on the Show/Hide button to the right of the password field. It must be spelled exactly as it is configured in your router including the capitalization!

After you enter your wireless name and password, click on Update Interface.

The Restart Network button will appear. **Do Not click on the Restart Network button.**

## Ethernet Network Settings

If you do not need to configure an Ethernet connection, then skip to the [Host & DNS Settings](#) section.

### Interface Settings

WIFI Drivers: External ▾

WIFI Regulatory Domain: United States ▾

Select an interface name to configure the network information for that interface.

Interface Name: 1 eth0  
wlan0

Interface Mode: 2  Static  DHCP

IP Address: 3 192.168.1.110 Ping

Netmask: 4 255.255.255.0

Gateway: 5 192.168.1.1 Ping

Update Interface
Restart Network
Create Persistent Names
Clear Persistent Names

1. Click on the eth0 interface (eth0 is the wired interface)
2. Select Static if you want to assign the IP address yourself, select DHCP if you want your router to assign the IP address. (refer to [Network Considerations](#) for more information.)  
Note: If you use DHCP, then the Host Name and DNS server is important to be configured correctly.
3. If you selected the Static option, enter your IP address, this address must be unique to this device interface.
4. The Netmask for most consumer networks is 255.255.255.0 (it should be the same as your show or home network router).



5. The Gateway will be the IP address of your home or show router and will usually get filled in, but make sure it is correct.

**Note: If you are using both network interfaces** (wlan0 and eth0) such as connecting to your home network through Wi-Fi and connecting to a controller or switch through the eth0 interface then **make sure the Gateway on the eth0 interface is left blank** while the Gateway on the wlan0 interface is set to your home (or show) Wi-Fi router (only one interface should have a gateway defined, all other interfaces should leave the gateway blank).

After you make sure that you have the correct Gateway address, click on Update Interface.

The Restart Network button will appear. **Do Not click on the Restart Network button.**

Click on the Host & DNS Settings Button

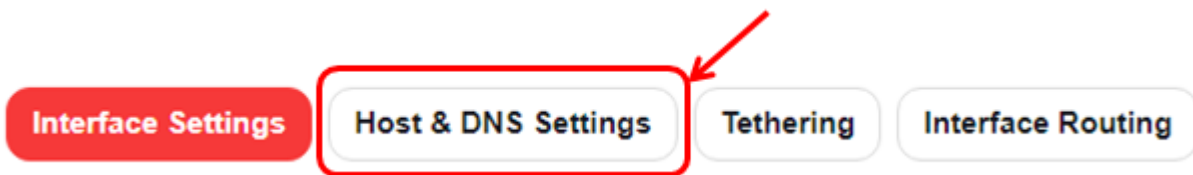

## Host & DNS Settings

You should have already entered your Host Name so all you will need to enter is the DNS Settings.

If you entered a Static Address for any of your interfaces, then you will need to enter a Manual DNS.

The screenshot shows the 'Host & DNS Settings' page. At the top, there is a navigation bar with four buttons: 'Interface Settings', 'Host & DNS Settings' (highlighted in red), 'Tethering', and 'Interface Routing'. Below this is the 'Host Settings' section with two input fields: 'Host Name' containing 'FPP-Pi4Test' and 'Host description' which is empty. Both fields have a question mark icon to their right. Below that is the 'DNS Settings' section. It starts with 'DNS Server Mode:' and two radio buttons: 'Manual' (selected) and 'DHCP'. Below this are two rows for DNS servers. The first row is 'DNS Server 1:' with an input field containing '192.168.1.1' and a 'Ping' button. The second row is 'DNS Server 2:' with an input field containing '8.8.8.8' and a 'Ping' button. At the bottom of the form is a large green button labeled 'Update DNS'.

Typically you should enter the IP address for your router for one of the DNS servers and 8.8.8.8 for the other.

If the FPP is going to be connected to a Wi-Fi interface and to a controller with an Ethernet cable or as a Standalone player sending data to a switch via Ethernet, then you need to Configure the interface Routing check the box at the bottom of the page to allow the data to pass through the FPP to the eth0 (this does not apply if you are using a cape or hat or running in Standalone mode.)

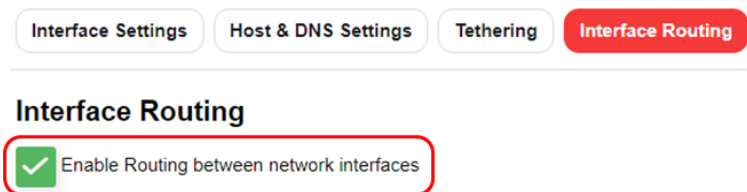

Once you have configured all of your network settings, eth0, wlan0, Host and DNS, double check them to make sure they are correct. If they are correct, then click on the Reboot button either in the red banner at the top of the page or at the bottom of the page.

**At this point, your FPP will need to be connected to your network based on the configuration you set it for during the installation.**

## Final configurations

Once you have your FPP connected to the network based on the configuration you entered in your network settings, you will have to open the FPP's web page based on the new settings or the page currently on your screen might not access your FPP device. You can get to the FPP device by typing the Host Name or IP address that you configured (or if it was DHCP assigned, then the IP address that your router assigned to it). If you cannot get to the FPP page, refer to the [Troubleshooting](#) section.

In most setup configurations, the FPP will have access to the internet and you can use the internet to keep the correct time.

If your FPP device will not have access to the internet and it has a Real Time Clock installed, then refer to the [Time](#) configuration section.

## Updating the Software

You should update to the current version of the software. To check for updates click on the Help then About:

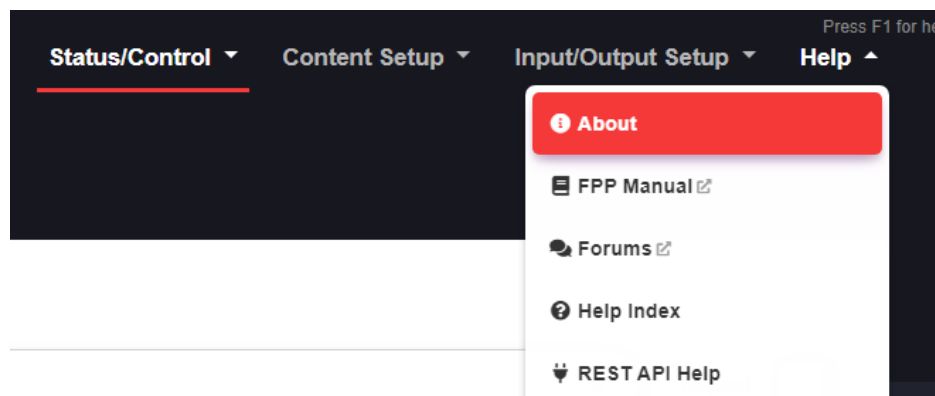

**About FPP** Status/Control Content Setup Input/Output

**Version Info**

FPP Version: 5.x-master-228-gf3a56c4f  
Platform: BeagleBone Black  
FPP OS Build: v5.0-alpha  
OS Version: Debian GNU/Linux 10 (buster)  
Hardware Serial Number: 2034SBB06537  
Kernel Version: 5.4.106fpp  
System Boot Time: 2021-06-29 08:13:33  
fppd Uptime: 866 days, 05:25:42  
Local Git Version: f3a56c4 [ChangeLog](#) **(Update is available)**  
Remote Git Version: 8536bbe [Preview Changes](#)  
Upgrade FPP: [Upgrade FPP](#)

**System Utilization**

CPU Usage: 100.00%  
Memory Usage: 22.43%

**Uptime**

09:39:06 up 1:25, load average: 0.43, 0.48, 0.53

**Player Stats**

Schedules: [Unknown](#)  
Playlists: 0  
Sequences: 0  
Audio Files: 0  
Videos: 0  
Command Presets: 0  
Effects: 0  
Scripts: 0

**Disk Utilization**

11%  
Root Free Space: 25.93 GiB (89%)  
11%  
Media Free Space: 25.93 GiB (89%)

On this screen, you will see the FPP Version you are using (in this case it is 5.x-Master) and if there is an update available, it will give you a notice. Click on the Upgrade FPP button.

If next to the Remote Git Version it says Unknown, that usually means FPP cannot reach the Internet. In most cases that means your network (usually the DNS configuration) is not set up properly. Refer to the [Troubleshooting](#) section for help.

**About FPP** Status/Control Content Setup Input/Output

**Version Info**

FPP Version: 5.x-master-228-gf3a56c4f  
Platform: BeagleBone Black  
FPP OS Build: v5.0-alpha  
OS Version: Debian GNU/Linux 10 (buster)  
Hardware Serial Number: 2034SBB06537  
Kernel Version: 5.4.106fpp  
System Boot Time: 2019-02-14 03:11:56  
fppd Uptime: 01:59  
Local Git Version: f3a56c4 [ChangeLog](#)  
Remote Git Version: **Unknown**  
Upgrade FPP: [Upgrade FPP](#)

**System Utilization**

CPU Usage: 64.91%  
Memory Usage: 19.88%

**Uptime**

03:15:23 up 3 min, load average: 3.00, 3.19, 1.42

**Player Stats**

Schedules: [Unknown](#)  
Playlists: 0  
Sequences: 0  
Audio Files: 0  
Videos: 0  
Command Presets: 0  
Effects: 0  
Scripts: 0

**Disk Utilization**

11%  
Root Free Space: 25.93 GiB (89%)  
11%  
Media Free Space: 25.93 GiB (89%)

You will get a progress screen similar to this; it could take several minutes to update:

```
FPP Upgrade
scripts/init_pre_network | 10 +-
scripts/piRTC | 7 +-
src/channeloutput/BBB48String.cpp | 4 +-
src/channeloutput/channeloutputthread.c | 20 ++-
src/channeloutput/channeloutputthread.h | 2 +
src/oled/SSD1306DisplayDriver.cpp | 2 +-
src/pru/FalconUtils.hp | 9 ++
src/pru/FalconWS281x.p | 39 ++++-
www/api/controllers/settings.php | 4 +-
www/backup.php | 6 +-
www/common.php | 61 ++++++-
www/common/settings.php | 11 +-
www/effects.php | 4 +-
www/fppjson.php | 6 +
www/js/fpp.js | 55 ++++++-
www/multisync.php | 263 ++++++-----
www/pixeloverlaymodels.php | 4 +-
www/playlistEntryTypes.json | 6 +-
www/scheduler.php | 6 +-
www/settings-av.php | 4 +-
www/settings-email.php | 4 +-
www/settings-storage.php | 25 +-
www/settings.json | 21 +-
www/settings.php | 2 +-
www/testing.php | 56 ++++++-
www/troubleshootingCommands.php | 22 +-
36 files changed, 493 insertions(+), 213 deletions(-)
Synchronizing submodule url for 'external/RF24'
Synchronizing submodule url for 'external/rpi-rgb-led-matrix'
Synchronizing submodule url for 'external/rpi_ws281x'
Synchronizing submodule url for 'external/spixels'
```

Once it has updated, look at the bottom of the screen and click on the Close button

```
ccache g++ -fpch-preprocess -O3 -Wno-psabi -pipe -I ./ -fpic -DPLATFORM_BBB
channeloutput/USBDMX.cpp -o channeloutput/USBDMX.o
ccache g++ -shared channeloutput/USBDMX.o -L. -lfpp -o libfpp-co-USBDMX.s
=====
Restarting fppd...
=====
Update Complete.
```

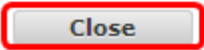

Sometimes there will be an additional Major update available, if so, click on the Upgrade button.

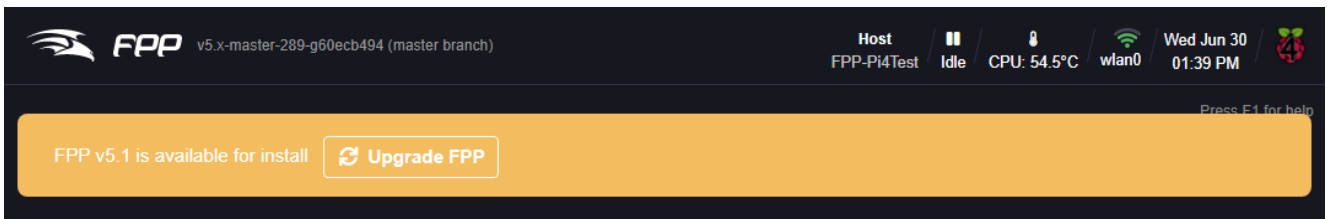

You will usually get a Release notes page; sometimes there are updates that require an update to the Operating System (OS) to get the full functionality and that information will be in the Release notes. Click on the Upgrade button.

Refer to the [Upgrade FPP section](#) for more information.

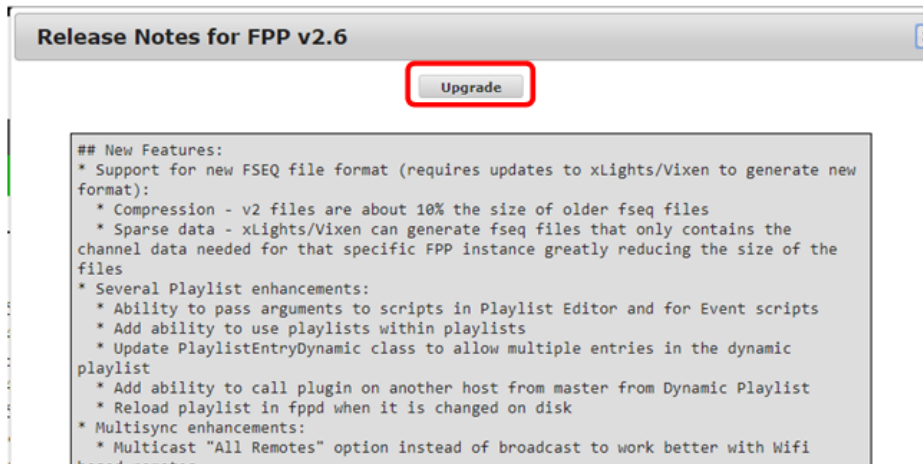

You should get a confirmation page, click OK

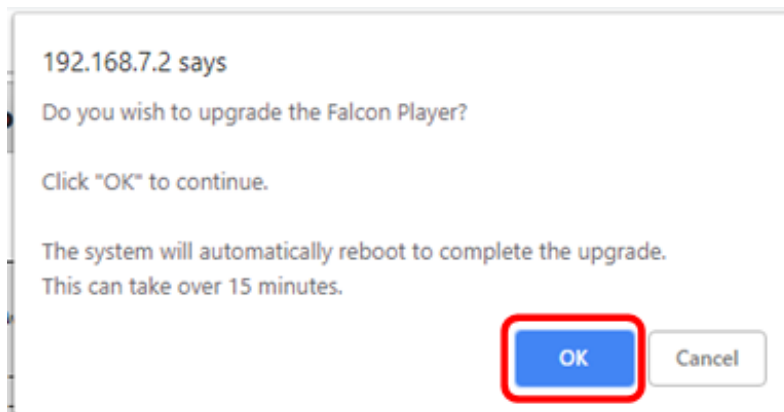

You will get an update screen, once it has updated, look at the bottom of the screen and click on the Close button

```
ccache g++ -fpch-preprocess -O3 -Wno-psabi -pipe -I ./ -fpic -DPLATFORM_BBB
channeloutput/USBDMX.cpp -o channeloutput/USBDMX.o
ccache g++ -shared channeloutput/USBDMX.o -L. -lfpp -o libfpp-co-USBDMX.o
=====
Restarting fppd...
=====
Update Complete.
```

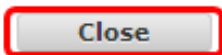

When the update is complete, the screen will return to the About Page. You can verify that it is up to date. If it is up to date, the Local Git version will be the same as the Remote Git Version.

#### Version Info

FPP Version: 5.x-master-287-g8536bbe8  
Platform: BeagleBone Black  
FPP OS Build: v5.0-alpha  
OS Version: Debian GNU/Linux 10 (buster)  
Hardware Serial Number: 2034SBB06537  
Kernel Version: 5.4.106fpp  
System Boot Time: 2021-06-29 10:02:59  
fppd Uptime: 01:41  
Local Git Version: 8536bbe [ChangeLog](#)  
Remote Git Version: 8536bbe  
Upgrade FPP: [Upgrade FPP](#)

#### Player Stats

Schedules: [Unknown](#)  
Playlists: 0  
Sequences: 0  
Audio Files: 0  
Videos: 0  
Command Presets: 0  
Effects: 0  
Scripts: 0

#### Disk Utilization

12%  
Root (mmcblk0p1) Free Space: 25.92 GiB (88%)

#### System Utilization

CPU Usage: 46.38%  
Memory Usage: 21.68%

#### Uptime

10:46:37 up 43 min, load average: 0.69, 1.23, 1.41

Your FPP software is now installed and up to date. There are many ways that FPP can be used and the settings required to run your show will vary depending on your particular setup. Refer to the appropriate section(s) for more information.

# General Overview

The developers have incorporated several methods to help users out and to explain the functionality of different settings. Most of the settings are loaded based on the device that the FPP is connected to so that it is less confusing. There are also different levels of the User Interface so that the more advanced settings/functions do not clutter up the screens. (Refer to the [UI Settings](#) for more information.)

Many of the settings or options will have a Help popup icon which is identified by the green question mark.

Hovering your mouse over the question mark will bring up some additional information specific to that item.

## General Audio/Video

Audio Output Device: bcm2835 ALSA (Pi Onboard Audio) ?

Audio Output Mixer Device: PCM ?

Audio Output Format: Default ?

Default Video Output Device: HDMI ?

Media/Sequence Offset: 0 ms ?

The Audio Output Device determines which audio device is used for audio playback. This may be an onboard analog audio device, the HDMI output on a Raspberry Pi, or a USB sound card.

# Program Settings and Navigation

The following sections will explain the program sections and settings and explain how they work. Depending on your current setup or version of FPP, the screens might be slightly different.

The Main Page is accessed by using a web browser and entering the IP address or HostName of the Raspberry Pi/BB that you previously set up. For example in this case: 192.168.1.101 or <http://YardPi.local/> (the actual IP or host name will be different depending on your setup).

At the top of each page is a status/navigation page.

1. At the top of each page, the current FPP version is displayed. In this case it is version 5.x-master. This is also a quick link that will take you to the [About](#) page to check for updates and other relevant data.

2. This is your Host Name. In this case the Host Name is FPP-Pi4Test and can be used to access this FPP using <http://FPP-Pi4Test.local/> (your actual name may be different depending on how you set it up) This is also a quick link to take you to the [Host & DNS Settings](#) page in case you need to make changes.
3. This shows the current status of this FPP. In this case it is showing idle because nothing is playing. If a sequence was playing, it would indicate Playing and if you hover over the icon, it will display what sequence is currently playing.

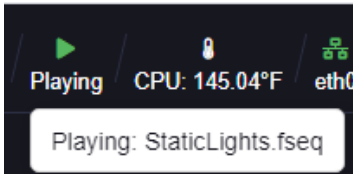

If FPP is stopped, it will show a Stopped Icon

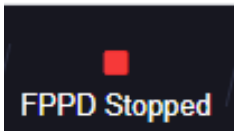

4. If your FPP device has a temperature sensor and/or voltage sensor, the temperature will display here. To change the units, go to the [FPP Settings>UI page](#).

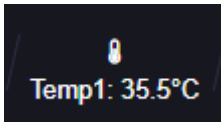

If it has more than one of the mentioned sensors, clicking on the icon will toggle through the different sensors.

5. This shows the current status of the Network Interfaces. There is a graphical representation of each interface and hovering your mouse over them will give you some additional information about the interface.

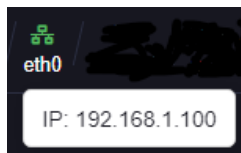

- a. Shows that you have a live Ethernet connection with an IP address of 192.168.1.100, but it doesn't mean that the connection is a valid one.



- b. **IP: 169.254.241.30** Shows that you have configured a DHCP Ethernet connection but the FPP device did not receive an IP address from the connected device and instead gave itself a Link-Local IP address of 169.254.241.30. This is likely due to the FPP device being hooked up to a controller or directly to a computer.

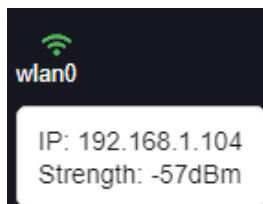

- c. Shows that there is a wlan0 connection with an IP address of 192.168.1.104 with a good signal strength of -57dBm. The signal strength is also indicated by the number of bars in green.



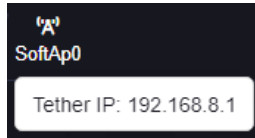

d. Shows that the FPP device is operating as a Wireless Access Point.

6. Current system date and time
7. This is a graphic of the hardware platform and variant (Raspberry or Beagle)
8. This shows what section of FPP you are in.
9. Main navigation toolbar for different areas for settings/configurations and will be on every page. Clicking on one of these headings will give you more options to choose for that category and will be explained in the section pertaining to that selection below.

In the upper right corner is a link that says “Press F1 for help.” Clicking on this link or pressing F1 on the keyboard will bring up help topics specific to the page you are currently viewing.

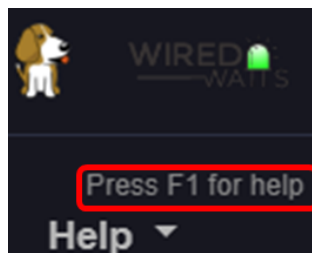

At the bottom of each page are controls for the Pi/BB SBC. These are shortcuts to some commonly used functions. used to reboot or shut down the Pi/BB. The Restart FPPD button, turns off the FPP Daemon, and restarts it. This allows the FPP to reload many of the configuration changes without having to do a full reboot of the Pi/BB.

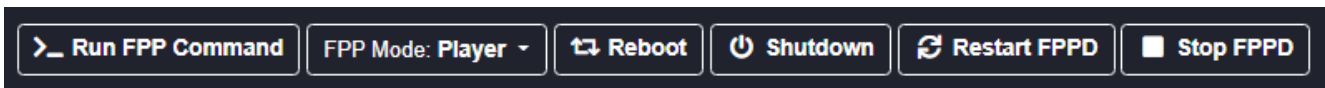

Run FPP Command- This will create a popup command window to run one of the pre-programmed FPP Commands (see the [Command Presets](#) for more information.)

FPP Mode- This allows you to change the FPP Mode. There are 2 Modes that FPP can run in:

1. Player-This setting is used when this FPP is going to be a player by itself or sending sequence data to other controllers. If the Player is going to communicate with other controllers then there are two ways to send data to the Remote FPP devices.
  - a. You can configure the FPP device in Player mode to output E1.31/DDP/ArtNet data to other controllers or FPP devices as needed. This will send the full pixel data frame by frame across the network to the other controllers. This is commonly used if you are connected to a wired network and controlling one or more controllers. If you are going to send data (DDP, E1.31 etc.) to the rest of your controllers then you will also need to have the appropriate Channel Outputs setup.
  - b. You can also configure FPP to send MultSync packets when in Player mode. This setting is used if you are going to have more than one FPP device and you want them to all be synchronized via small sync packets. The 'Remote' FPP will

need a copy of the sequences (.fseq) and media (music/video) files. The 'Player' will be where your Playlists and Schedules are created.

2. Remote- This Mode is used if you are going to synchronize this FPP (and attached controller or cape) to a Player FPP. This can be done two ways:
  - a. MultiSync- The remote will listen for MultiSync packets from a Player FPP and will sync its output with the Player FPP. The Remote will need a copy of all the sequences (.fseq) that are going to be played. You will also need to have the appropriate Channel Outputs setup. Refer to the [Standalone](#) and [Wired Separate Show Network](#) sections for more information.
  - b. E1.31/DDP/ArtNet- This configuration is used if your remote is going to receive E1.31/DDP/ArtNet data. This will require that the E1.31/DDP/ArtNet inputs have been configured. Refer to the [MultiSync/Remote](#) section for more information.

Reboot- This will reboot the FPP Device.

Shutdown- This will shutdown the FPP device.

Restart FPPD- This will restart the FPPD software.

Stop FPPD- This will stop the FPPD software.

If there is a major upgrade available for the installed version, then a orange bar will be displayed to give you the opportunity to upgrade to the next version. Minor versions will have to be manually installed from the Help>About page.

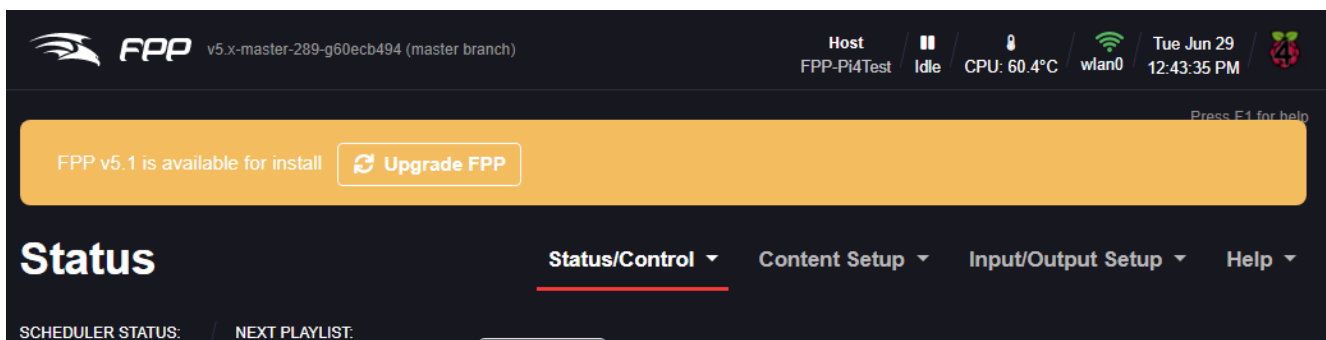

# Status/Control

This section is for various settings and status reports. Clicking on the Status/Control tab will give you several options to choose from:

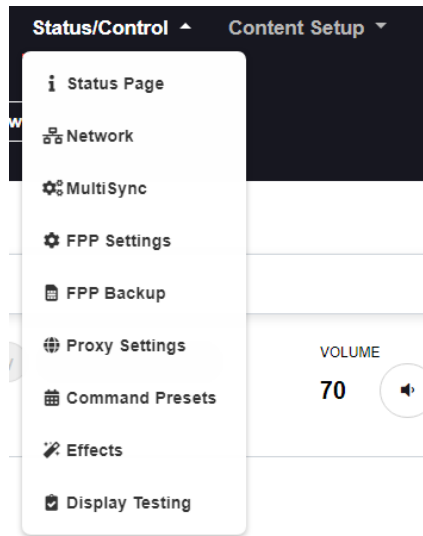

## Status Page

The Status Page is the default page that will load when you first log into FPP. Depending on what mode FPP is running, the screens will look a little different.

## Player Status Page

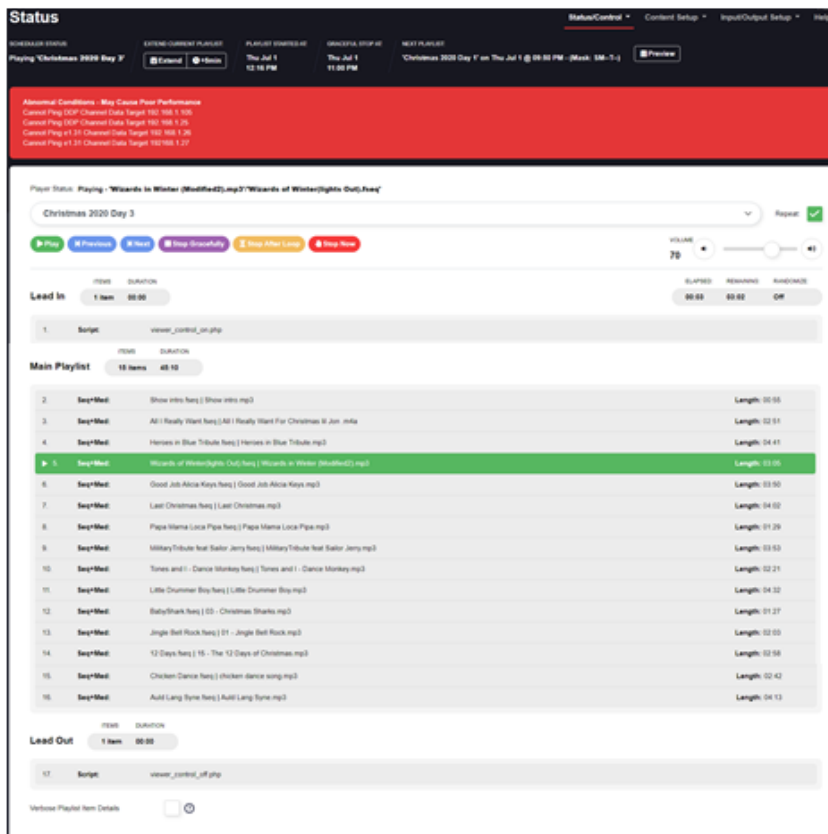

There are several sections on the Status page.

## Scheduler Status

This section will show the status of your Scheduler and options to control a playlist that is playing.

**Note: This screenshot is showing Abnormal Conditions and this is not a normal status. You should remedy any abnormal conditions.**

The screenshot shows the Scheduler Status interface. At the top, there are six numbered callouts (1-6) pointing to different sections: 1. SCHEDULER STATUS: Playing 'Christmas 2020 Day 3'. 2. EXTEND CURRENT PLAYLIST: Buttons for 'Extend' and '+5min'. 3. PLAYLIST STARTED AT: Thu Jul 1 12:16 PM. 4. GRACEFUL STOP AT: Thu Jul 1 11:00 PM. 5. NEXT PLAYLIST: 'Christmas 2020 Day 1' on Thu Jul 1 @ 09:50 PM - (Mask: SM--T--). 6. Preview button. Below these is a red banner with callout 7 pointing to a message: 'Abnormal Conditions - May Cause Poor Performance' followed by four lines of error messages: 'Cannot Ping DDP Channel Data Target 192.168.1.105', 'Cannot Ping DDP Channel Data Target 192.168.1.25', 'Cannot Ping e1.31 Channel Data Target 192.168.1.26', and 'Cannot Ping e1.31 Channel Data Target 192.168.1.27'.

1. Current Playlist- This will show the currently playing playlist. If there is no playlist playing, then it will show as Idle. If the playlist was manually started then it will indicate (Manually Started) at the end of the playlist name.
2. Playlist time extension-You can manually extend (or reduce) a Scheduled playlist that is running. If you click on the Extend button, you can change the scheduled end time in minutes (you can use a negative number to shorten the end time). There is another button to extend the playlist in increments of 5 minutes. You can only change the end time by a maximum of 720 minutes (12 hours) or reduce it by 360 minutes (3 hours). Once a playlist has reached its scheduled end time, this option will no longer be available even though a song might still be playing (i.e. Graceful shutdown)
3. Playlist Started at- This will show what time the scheduled show started.
4. "StopType"- This will indicate the stop strategy for the scheduled playlist that is currently playing and the time it is scheduled to stop.
5. Next Playlist-The next scheduled playlist will show what playlist is scheduled to play next and the start time and day that it will start.
6. Preview- This will show you a graphical representation of your schedule for the next 7 days. This is a good way to verify your schedule.

TIME	ACTION	ARGS
Thu Jul 1 @ 12:00 PM	Start Playing	Christmas 2020 Day 3 (Repeating w/ Graceful Stop)
Thu Jul 1 @ 09:50 PM	Start Playing	Christmas 2020 Day 1 (Repeating w/ Graceful Stop)
Thu Jul 1 @ 10:00 PM	Start Playing	AfterHours (Repeating w/ Graceful Stop)
Thu Jul 1 @ 11:00 PM	End Playing	Christmas 2020 Day 1 (Graceful Stop)
Fri Jul 2 @ 12:00 AM	Start Playing	Christmas 2020 Day 1 (Repeating w/ Graceful Stop)
Fri Jul 2 @ 02:00 AM	End Playing	AfterHours (Graceful Stop)
Fri Jul 2 @ 12:00 PM	End Playing	Christmas 2020 Day 1 (Graceful Stop)
Fri Jul 2 @ 09:50 PM	Start Playing	Christmas 2020 Day 2 (Repeating w/ Graceful Stop)
Fri Jul 2 @ 09:50 PM	Start Playing	Christmas 2020 Day 2 (Repeating w/ Graceful Stop)
Fri Jul 2 @ 10:00 PM	Start Playing	AfterHours (Repeating w/ Graceful Stop)
Fri Jul 2 @ 11:00 PM	End Playing	Christmas 2020 Day 2 (Graceful Stop)
Sat Jul 3 @ 12:00 AM	Start Playing	Christmas 2020 Day 1 (Repeating w/ Graceful Stop)
Sat Jul 3 @ 02:00 AM	End Playing	AfterHours (Graceful Stop)
Sat Jul 3 @ 12:00 PM	End Playing	Christmas 2020 Day 1 (Graceful Stop)
Sat Jul 3 @ 12:00 PM	Start Playing	Christmas 2020 Day 3 (Repeating w/ Graceful Stop)
Sat Jul 3 @ 09:50 PM	Start Playing	Christmas 2020 Day 3 (Repeating w/ Graceful Stop)
Sat Jul 3 @ 10:00 PM	Start Playing	AfterHours (Repeating w/ Graceful Stop)
Sat Jul 3 @ 11:00 PM	End Playing	Christmas 2020 Day 3 (Graceful Stop)
Sun Jul 4 @ 12:00 AM	Start Playing	Christmas 2020 Day 1 (Repeating w/ Graceful Stop)
Sun Jul 4 @ 02:00 AM	End Playing	AfterHours (Graceful Stop)
Sun Jul 4 @ 12:00 PM	End Playing	Christmas 2020 Day 1 (Graceful Stop)
Sun Jul 4 @ 09:50 PM	Start Playing	Christmas 2020 Day 1 (Repeating w/ Graceful Stop)
Sun Jul 4 @ 10:00 PM	Start Playing	AfterHours (Repeating w/ Graceful Stop)
Sun Jul 4 @ 11:00 PM	End Playing	Christmas 2020 Day 1 (Graceful Stop)
Mon Jul 5 @ 12:00 AM	Start Playing	Christmas 2020 Day 1 (Repeating w/ Graceful Stop)
Mon Jul 5 @ 02:00 AM	End Playing	AfterHours (Graceful Stop)
Mon Jul 5 @ 12:00 PM	End Playing	Christmas 2020 Day 1 (Graceful Stop)
Mon Jul 5 @ 09:49 PM	Start Playing	Christmas 2020 Day 1 (Repeating w/ Graceful Stop)
Mon Jul 5 @ 10:00 PM	Start Playing	AfterHours (Repeating w/ Graceful Stop)
Mon Jul 5 @ 11:00 PM	End Playing	Christmas 2020 Day 1 (Graceful Stop)
Tue Jul 6 @ 12:00 AM	Start Playing	Christmas 2020 Day 1 (Repeating w/ Graceful Stop)
Tue Jul 6 @ 02:00 AM	End Playing	AfterHours (Graceful Stop)
Tue Jul 6 @ 12:00 PM	End Playing	Christmas 2020 Day 1 (Graceful Stop)
Tue Jul 6 @ 09:49 PM	Start Playing	Christmas 2020 Day 2 (Repeating w/ Graceful Stop)
Tue Jul 6 @ 10:00 PM	Start Playing	AfterHours (Repeating w/ Graceful Stop)
Tue Jul 6 @ 11:00 PM	End Playing	Christmas 2020 Day 2 (Graceful Stop)
Wed Jul 7 @ 12:00 AM	Start Playing	Christmas 2020 Day 1 (Repeating w/ Graceful Stop)
Wed Jul 7 @ 02:00 AM	End Playing	AfterHours (Graceful Stop)
Wed Jul 7 @ 12:00 PM	End Playing	Christmas 2020 Day 1 (Graceful Stop)
Wed Jul 7 @ 12:00 PM	Start Playing	Christmas 2020 Day 3 (Repeating w/ Graceful Stop)
Wed Jul 7 @ 10:00 PM	Start Playing	AfterHours (Repeating w/ Graceful Stop)
Wed Jul 7 @ 11:00 PM	End Playing	Christmas 2020 Day 3 (Graceful Stop)
Thu Jul 8 @ 02:00 AM	End Playing	AfterHours (Graceful Stop)

7. Abnormal Conditions- If the FPP device identifies some conditions that can impact performance, then the messages will be listed in this section. A list of the errors and possible fixes are listed in the [Troubleshooting](#) section.

### Player Status

The screenshot shows the FPP Player Status interface. It includes a status bar at the top with the text "Player Status: Playing - 'Wizards in Winter (Modified2).mp3'/'Wizards of Winter(lights Out).fseq'", a song title "Christmas 2020 Day 3", and playback controls (Play, Previous, Next, Stop Gracefully, Stop After Loop, Stop Now). A volume slider is set to 70. At the bottom, there is a table with columns for ITEMS, DURATION, ELAPSED, REMAINING, and RANDOMIZE. The table shows 1 item with a duration of 00:00, and the elapsed time is 00:03 with 03:02 remaining. A "Repeat" checkbox is checked.

1. Player Status-this lists the current song that is playing.

2. Playlist/Sequence Selector- This will show the playlist that is playing when one is playing, otherwise you can use it to select a playlist or individual sequence to play manually.
3. Player controls-This controls the currently queued playlist.
  - a. Play-This will play the queued playlist at the element selected. If the Repeat box is checked, the playlist will continue to play until manually stopped or a scheduled playlist starts.
  - b. Previous- This will step to the previous playlist item when a playlist is playing.
  - c. Next- This will step to the next playlist item when a playlist is playing.
  - d. Stop Gracefully-This will finish the song that is currently playing and then stop the playlist.
  - e. Stop After Loop-This will stop the playlist when the end of the currently playing playlist is reached.
  - f. Stop Now-This will stop the playlist immediately.
4. Repeat- If this box is checked when you manually start a playlist or sequence, it will continue to play until it is manually stopped.
5. Volume-This is where you can control the output volume for the currently playing sequence. This can be used to control the volume supplied to an FM transmitter or external speakers.
6. Song Status- This will show how long the current song has been playing and how much time is remaining. It also will indicate if the playlist is set to Random order.

If there is no sequence playing, the status will be "Idle." It will also indicate if a playlist is shutting down gracefully (finishing the song and then shutting down.)

- a. Playlist-This is a dropdown box with your playlists and sequences so that you can manually start one of your stored playlists or sequences.
  - b. Repeat- If this box is checked when you manually start a playlist or sequence, it will continue to play until it is manually stopped.
  - c. Volume-This is where you can control the output volume for the currently playing sequence. This can be used to control the volume supplied to an FM transmitter or external speakers.
  - d. Verbose Playlist Item Details- If this is selected, it will show a lot more information on each playlist item.
  - e. Playlist Details-This will show you the details of the currently queued playlist. If the playlist is playing, it will indicate which song is playing by highlighting it and putting an arrow next to it.
2. Player controls-This controls the currently queued playlist.
    - a. Play-This will play the queued playlist at the element selected. If the Repeat box is checked, the playlist will continue to play until manually stopped or a scheduled playlist starts.
    - b. Previous- This will step to the previous playlist item when a playlist is playing.
    - c. Next- This will step to the next playlist item when a playlist is playing.
    - d. Stop Gracefully-This will finish the song that is currently playing and then stop the playlist.
    - e. Stop After Loop-This will stop the playlist when the end of the currently playing playlist is reached.
    - f. Stop Now-This will stop the playlist immediately.

## Playlist Details

This section will show the details of the currently selected playlist (for more information on Playlists refer to the Playlist section.)

The screenshot displays the FPP interface with the following sections and highlighted elements:

- Lead In:** Shows 1 item with a duration of 00:00. A red box labeled '1' highlights the item count and duration.
- Main Playlist:** Shows 15 items with a total duration of 45:10. A red box labeled '2' highlights the item count and duration. Below this, a list of 16 items is shown, each with a 'Seq+Med' name and a 'Length'. Item 5, 'Wizards of Winter(lights Out).fseq | Wizards in Winter (Modified2).mp3', is highlighted in green. A red box labeled '3' highlights the 'Length' column.
- Lead Out:** Shows 1 item with a duration of 00:00. A red box labeled '4' highlights the item count and duration.
- Verbose Playlist Item Details:** A checkbox is present, currently unchecked. A red box labeled '5' highlights the checkbox and its label.

1. Lead In- If your playlist has any Lead In items, they will be listed in this section with details in regards to total items and the duration of each item.
2. Main Playlist- This will display an overview of your Main Playlist. It will list the number of items in your playlist and the duration of all of the playlist items.
3. Playlist Details-This displays all of the items in your Main Playlist. It shows the Sequence name and the associated audio file. If the playlist is playing, then the currently playing item will be highlighted.
4. Lead Out- If your playlist has any Lead Out items, they will be listed in this section with details in regards to total items and the duration of each item.
5. Verbose Playlist Item Details- If you select this option, it will give you more details on the items in the playlist. This is helpful if you have scripts or FPP Commands to see all of the arguments defined for the script or command.



# Remote Mode Status page

The screenshot shows the Remote Mode Status page with the following elements highlighted by numbered callouts:

- 1:** Remote Status: Syncing to Player: Elapsed: 00:04 Remaining: 03:18
- 2:** Player IP: 192.168.1.100 (FPPMaster)
- 3:** Sequence Filename: Mary Did You Know.fseq
- 4:** Media Filename:
- 5:** VOLUME 70
- 6:** MultiSync Packet Counts table

Host	Last Rcvd	Sequence Sync				Media Sync				Blank Data	Ping	Plugin	FPP Cmd	Errors
		Open	Start	Stop	Sync	Open	Start	Stop	Sync					
192.168.1.100	2021-07-29 22:00:50	4	4	2	717	6	4	3	692	1	4	0	0	0
192.168.1.101	2021-07-29 21:56:45	0	0	0	0	0	0	0	0	0	10	0	0	0
192.168.1.250	2021-07-29 21:46:20	0	0	0	0	0	0	0	0	0	6	0	0	0
192.168.1.251	2021-07-29 21:56:47	0	0	0	0	0	0	0	0	0	5	0	0	0

1. Remote Status- This shows the Remote Mode sync status. It will show if it is actively syncing to a Player FPP device, how much time has elapsed for the current sequence, and how much time is left on the current sequence.
2. Player IP- This shows which FPP device is currently sending the sync packets. It includes the IP address, which is a hyperlink to that device, and the Host Name for that device.
3. Sequence Filename- This shows the currently playing sequence.
4. Media Filename- If your playlist is playing a media (audio/video) file then this will show the media file that is being played.
5. Volume- This will control the volume of the media being played on this FPP.
6. MultiSync Packet Counts-This section shows all of the different sync commands that have been received from other devices. There is a Live Update Stats option that will refresh the page every second for current stats. The Update button will refresh the data. You can also reset the history by clicking on the Reset button.
  - a. Host- This will list the IP addresses of any device that has communicated with this device.
  - b. Last Received- This will indicate the last day and time that the Remote received any communication with the associated device.
  - c. Sequence Sync- This will show the stats for the various Sequence Sync messages received.
  - d. Media Sync- This will show the stats for the various Media Sync messages received.
  - e. Blank Data- This will show the stats for the Blanking Data received.
  - f. Ping- This will show the stats for devices that have Pinged the remote.
  - g. Plugin- This will show the stats for Plugin commands received.
  - h. FPP Cmd- This will show the stats for FPP commands received.



- i. Errors- This will show the stats for any errors encountered.

## Channel Inputs Status Section

If you have Channel Inputs enabled (refer to [Channel Inputs](#) for more information) and your FPP has received Channel Input data, then you will have an additional screen in the lower portion of the window.

### E1.31/DDP/ArtNet Packets and Bytes Received

<input type="button" value="Update"/>	<input type="button" value="Reset"/>	<input checked="" type="checkbox"/> Live Update Stats		
UNIVERSE	START ADDRESS	PACKETS	BYTES	ERRORS
DDP	14446-14460	790	11850	0

This section shows the status of the packets received. It shows the Universes that have been configured to receive the Bridge data and the stats of the packages received. There is a Live Update Stats option that will refresh the page every second for current stats. The Update button will refresh the data. You can also reset the history by clicking on the Reset button.

## Network

The Network page is where you set up your Network settings so that you can communicate with your FPPs and controllers and all of your FPPs and controllers can communicate as needed with each other. Networking works similarly whether you use wireless or wired and they work together. There are four tabs in the Network Settings page for the different sections that might need to be configured.

Interface Settings
Host & DNS Settings
Tethering
Interface Routing

### Interface Settings

WIFI Drivers: External

WIFI Regulatory Domain: United States

Select an interface name to configure the network information for that interface.

Interface Name: wlan0

Interface Mode:  Static  DHCP

IP Address: 192.168.1.104 Ping

Netmask: 255.255.255.0

Gateway: 192.168.1.1 Ping

**Wireless Settings:**

WPA SSID: YourNetworkID  Hidden

WPA Pre Shared key (PSK): ..... Show

Update Interface
Create Persistent Names
Clear Persistent Names

Because there are so many variations of configuring a network, the network settings seem to be problematic for some people. The basic setup at the beginning of this manual should get you running. That setup might not be the best for you in the long run. The following should get you a better understanding for a better setup for your particular situation.

Canispater Christmas has a good video at <https://youtu.be/kn1BiolQbgw> and Keith Westley, one of the xLights developers, has a good video as well at <https://youtu.be/g0fOZs6UgXw>.

There is a good article that you should read about wireless and remotes at: <https://falconchristmas.com/forum/index.php/topic.4231.0.html>.

If you need more information on networks and IP addresses and how they work, then refer to the [Networking Configuration](#) section of the Advanced Options section.

## Interface Settings

Depending on the device, the FPP could have up to 2 network devices built-in (more if you install additional network adapters, but this is not common). One is labeled eth0 for Ethernet connections (wired) and the other is wlan0 connections (wireless). If you have both eth0 and wlan0 on your FPP, then you have to select and configure each one separately.

## Interface Settings

WIFI Drivers:

External ▾

WIFI Regulatory Domain:

United States ▾

Select an interface name to configure the network information for that interface.

Interface Name:

wlan0

Interface Mode:

 Static  DHCP

IP Address:

192.168.1.104

Ping

Netmask:

255.255.255.0

Gateway:

192.168.1.1

Ping

### Wireless Settings:

WPA SSID:

YourNetworkID

Hidden

WPA Pre Shared key (PSK):

.....

Show

Update Interface

Create Persistent Names

Clear Persistent Names

Wi-Fi drivers- Usually the External Drivers will work the best, but there might be some off brand USB Wi-Fi adapters that will need to be configured with the internal drivers. Wi-Fi Regulatory Domain- Enter the county you are in. Some jurisdictions have regulations and in order for the Wi-Fi to work, this needs to be configured correctly.

Interface Name- This section will list all of your internet interfaces, eth interfaces (eth0, eth1, etc.) are Ethernet interfaces and wlan interfaces (wlan0, wlan1, etc.) are wireless interfaces. Selecting one of the items in this list will take you to the settings for that interface..

Interface Mode-

- DHCP-Your home router will assign and manage the IP address(es) for your FPPs and controllers, this is the easiest method but has some drawbacks. Your router might not save the IP address if your FPP has been disconnected for a lengthy time so it might cause problems in the future when the IP address changes. Also, your FPP has to be connected to a network(or a device that will forward the communication) that has a DHCP Server.
- Static-You will assign the IP address for your FPPs and controllers. This is usually the preferred method so that you can always access your devices. Using this option, you have to make sure that the IP addresses are unique. You have to be careful to not assign an IP address to an address that your router has already assigned to another device through the DHCP process. Many routers will assign DHCP addresses at the lower end of the range, but this isn't always true. Some routers have the ability for you

to limit the range of IP addresses that it will use for DHCP in order to prevent any conflicts.

**NOTE: If you are using both network interfaces they should be on different subnets! Also only assign one interface to have a Gateway and that will typically be the interface that is connected to your home network.**

IP address- This will be the IP address for this particular FPP device and interface. This IP address must be unique and no other devices should share this address. The IP address must be in the same subnet as the network it will be communicating with (this is usually the first three sets of numbers in the IP address).

Netmask- This is a mask that defines the size of your network, most consumer networks use 255.255.255.0 as the netmask.

Gateway- The Gateway should only be configured on the network interface that is communicating with your home or show router. If you have two network interfaces, then only one should have a Gateway configured. The Gateway should be the IP address of the router that this interface is connected to.

If you are configuring the wlan0 interface then you will have some additional settings to configure.

#### Wireless Settings:

WPA SSID:

YourNetworkID

Hidden

WPA Pre Shared key (PSK):

.....

The WPA SSID is your wireless network name and the WPA Pre Shared Key is the password for your Wi-Fi. If you are connecting to an SSID that is configured to be hidden, then you will need to check the Hidden box.

The WPA Pre Shared Key (password) is normally hidden but you can elect to display your Pre Shared key if you want to verify that you input it correctly.

Update Interface- This button saves your settings. If you need to set up the other network, click on the Update Interface before you navigate to the next interface then you will have the options to enter your details for the selected interface. Make sure to click on Update Interface when you finish with each interface. When you are finished with all of your changes, reboot the FPP.

If you are unsure of what your settings should be, refer to the [Network Configuration](#) section of the manual.

If you are using more than one Ethernet interface (common for users with a Color-Light board) and you need the Ethernet adapter to keep the configuration order, then you can create a Persistent Name. The best practice would be:

- Power down the FPP device.
- Make sure that only the primary Ethernet interface is installed.
- Power up the FPP device.
- Plug in the USB Ethernet adapter.
- configure the eth0 and eth1 devices

- Click on Update Interface
- Click on Create Persistent Name

This will save your eth0 and eth1 configurations so that they will load up in the correct order..

## Host & DNS Settings

This section is to assign the Host Name and DNS settings that are for this device.

### Host Settings

Host Name	<input type="text" value="FPPMaster"/>	
Host description	<input type="text"/>	

### DNS Settings

DNS Server Mode:	<input checked="" type="radio"/> Manual <input type="radio"/> DHCP	
DNS Server 1:	<input type="text" value="192.168.1.1"/>	<input type="button" value="Ping"/>
DNS Server 2:	<input type="text" value="8.8.8.8"/>	<input type="button" value="Ping"/>

HostName- The HostName is the “human” name that you can use to access your FPP device. It is like typing google.com instead of typing 172.217.3.174 but be aware that if you don’t have a proper DNS server set up or another part of your network isn’t configured properly, then the HostName might not work properly but you should still be able to access FPP by typing in the IP address. You should change the HostName to something that is meaningful to you. It is important that your FPP/Controllers have unique Host names. Something like FPPMaster, FrontLawn, HouseOutline, whatever fits your situation and makes sense to you. If you are not going to have any other FPP instances then you can keep it as FPP if you want but it is not recommended because in this hobby, people have a tendency to expand their show and it is highly recommended that you rename it so there will be no confusion in the future. The HostName can only have letters, numbers, and hyphens (-). It may not begin or end with a hyphen and cannot have any spaces. Once you change the HostName you will no longer be able to access it in your web browser using <http://fpp.local/>. You can access it using the name that you just created or the IP address, which is why the name should make sense to you. Make sure you save your name after entering it. So if you changed the HostName to YardProps, then you could access the FPP by typing <http://Yardprops.local/>. You can also add more descriptive information about this FPP in the Host Description box and that information will show up in other sections of FPP such as Multisync.

Host Description-This is used to provide some additional information or a more meaningful name for your device and does not have the limitations as the Host Name. This will show up in your Multi-Sync page and the xLights FPP connect screen.

DNS Server Mode- This is to select what DNS server the FPP is going to use. If you are using DHCP addresses on all of your interfaces, then you should set the DNS Server Mode to DHCP as well. If you select DHCP then the FPP device will attempt to get a DNS address from the DHCP Server (usually your home router). Not all connected devices have a DNS server so selecting DHCP might not work. (See the [Network Configuration](#) for more information.) If you have set a Static IP address on any of your interfaces, then you need to configure the DNS Server. You have the option of selecting a main DNS Server and a backup one. It is usually recommended to set one server to 8.8.8.8 and the other to the IP address of your router.

Make sure you click on the Update DNS button to save your settings once you are done.

## Tethering

There are two types of Tethering that can be used with FPP. One is Wi-Fi Tethering where the FPP will behave as its own Access Point and USB Tethering where the FPP is connected directly to the computer via a USB cable.

### Wi-Fi Tethering

Wi-Fi Tethering is useful in order to access the FPP if there is no network connected to either the Ethernet or Wi-Fi connection. This is especially useful for the Raspberry Pi. To connect to the FPP device when the Wi-Fi Tethering mode is active, your FPP device will need to be fairly near your computer. You will then need to connect to the FPP Wi-Fi network that should be visible in your computer's network settings. Depending on your Operating system the process could be different but the process is the same as when you first connected your computer to your home Wi-Fi.

The password for the FPP network will be Christmas. Once you are connected to the FPP network, you can access the FPP with the IP address of 192.168.8.1

### Tethering

Tethering Mode	If no connection ▼ ?
Tethering Interface	wlan0 ▼ ?
Tethering Technology	Hostapd ▼ ?
Tethering SSID	FPP ?
Tethering Pre Shared Key (PSK)	..... ?

**Warning:**

Turning on tethering may make FPP unavailable. The WIFI adapter will be used for tethering and will thus not be usable for normal network operations. The WIFI tether IP address will be 192.168.8.1 for Hostapd tethering, but unpredictable for ConnMan (although likely 192.168.0.1).

On the Pi Zero and Pi Zero W devices, USB tethering is available if using an appropriate USB cable plugged into the USB port, not the power-only port. Don't plug anything into the power port for this. The IP address for USB tethering would be 192.168.7.2.

There are 3 WI-FI tethering modes available

- If no connection-This is the default setting. If the FPP device does not detect a network connected to any of the network ports, it will activate a Wi-Fi access point when it powers up called FPP.
- Enabled-When this option is selected; the FPP device will boot up and activate the Wi-Fi access point.
- Disabled-When this option is selected; the Wi-Fi access point will not be activated.

You can change the SSID name and password if you want, but it is not recommended.

There is a warning but this warning is more for the BeagleBone SBCs where you have to add a separate USB Wi-Fi adapter. The Raspberry Pi's internal Wi-Fi works well in the Wi-Fi Tether option and if you are using a BB SBC it is recommended to use a USB tether connection or Ethernet connection.

## USB Tethering

There is also the option of using USB tethering for the BB SBCs, Raspberry Pi Zero, and the Pi Zero-W. To connect using the USB tethering, connect the SBC via the USB port to your computer. (On the Pi Zeros, there are two USB ports, one is for power only, the other is a true USB connection, make sure you connect to the correct port. This will supply the power as well.) After the SBC is properly connected and is booted up, you can access the FPP by using the IP address of 192.168.7.2 if you are using a Windows computer or 192.168.6.2 if you are using a Mac or Linux computer.

**Note: Due to the number of various USB Wi-Fi adapters, the Wi-Fi Tethering might not work using a USB Wi-Fi adapter (this does not apply to the internal Wi-Fi adapters on the Raspberry Pis or BeagleBones). The recommended method of Tethering the BeagleBones is through the wired USB connection.**

## Interface Routing

If you are using your FPP device to communicate to one network via Wi-Fi and passing the communication through to your eth0 interface then you need to check the Enable Routing between network interfaces. (Like a controller attached to your FPP device, not a hat or cape.) This will allow communications to pass through your FPP device to the connected controller. This doesn't apply if you are using the FPP as a Proxy Host.

Interface Settings

Host & DNS Settings

Tethering

Interface Routing

### Interface Routing



Enable Routing between network interfaces

# MultiSync

The MultiSync page is typically where you set up a MultiSync/Remote Layout but has evolved into a much more useful interface for all of your FPP devices and most controllers. A MultiSync/Remote layout can eliminate the need for Ethernet cables connecting all of your FPPs/controllers and allows for widespread model placement. You can use a MultiSync/Remote configuration with a wired setup as well to save network traffic but usually doesn't give you a lot of benefit. You can also see the status and other system information on all of your FPP devices and upgrade them from one interface. See the [MultiSync/Remote](#) section of the Advanced Settings section for more information on the setup and functionality of the MultiSync/Remote layout.

**Note: In the displayed images, several errors are shown for demonstration purposes, this is NOT normal.**

**The MultiSync page will display differently depending on your user level and the mode the FPP device is configured.**

The screenshot shows the FPP MultiSync web interface. At the top, there are navigation tabs: Status/Control (selected), Content Setup, Input/Output Setup, and Help. Below the navigation is a table with columns: Hostname, IP Address, Platform, Mode, Status, Elapsed, Version, Git Versions, and Utilization. The table contains several rows of device information, including FPPMaster, FPP-Pi4Test, FPP-BB-Test, F16V3, FPP-PocketScroller, and YardPi. Some rows show error messages in red, such as 'Cannot Ping e1.31 Channel Data Target' and 'Received E1.31 data from'. At the bottom of the table, there are buttons for Settings, Refresh Stats, and Auto Refresh Stats (checked). There is also a dropdown menu for 'Action for selected systems' with a 'Run' button and a 'Clear List' button.

Hostname	IP Address	Platform	Mode	Status	Elapsed	Version	Git Versions	Utilization
FPPMaster	192.168.1.100	Raspberry Pi Raspberry Pi 3 Model B Rev 1.2	Player	Playing: Mary Did You Know.fseq 06 - Mary Did You Know__mp3	00:46	FPP: 5.x-master-395-g8042f928 OS: v4.2	Local: 8042f92 Remote: bd49b5a Branch: master	CPU: 11% Mem: 16% More...
FPP-Pi4Test	192.168.1.250	Raspberry Pi Raspberry Pi 4 Model B Rev 1.1	Player	Idle		FPP: 5.x-master-398-geb4bfa89 OS: v5.0-alpha	Local: eb4bfa8 Remote: bd49b5a Branch: master	CPU: 1% Mem: 12% More...
FPP-BB-Test	192.168.1.251	BeagleBone Black TI AM335x BeagleBone Black	Player	Idle		FPP: 5.x-master-399-gbd49b5a9 OS: v5.0-alpha	Local: bd49b5a Remote: bd49b5a Branch: master	CPU: 7% Mem: 25% More...
F16V3	192.168.101.2	Falcon F16v3 Falcon F16v3	Bridge	Last Seen: 2021-07-30 08:37:52		2.5		
FPP-PocketScroller	192.168.1.104	BeagleBone Black TI AM335x PocketBeagle	Remote	Playing: Mary Did You Know.fseq	00:46	FPP: 5.x-master-398-geb4bfa89 OS: v4.2	Local: eb4bfa8 Remote: bd49b5a Branch: master	CPU: 19% Mem: 43% More...
YardPi	192.168.1.101	Raspberry Pi Raspberry Pi 3 Model B Rev 1.2	Remote	Playing: Mary Did You Know.fseq	00:46	FPP: 4.6.1 OS: v4.4	Local: 939c605 Remote: 839c605 Branch: v4.6	CPU: 2% Mem: 12% More...

You can filter or sort the list by typing information in the header of each column or clicking the arrow icons next to the header title.

This is a close-up of the table header from the screenshot above. It shows the column titles: Hostname, IP Address, Platform, Mode, Status, Elapsed, Version, Git Versions, and Utilization. Each header has a small arrow icon next to it, indicating that the columns can be sorted or filtered.

Some of the boxes have drop down selectors to filter the display.



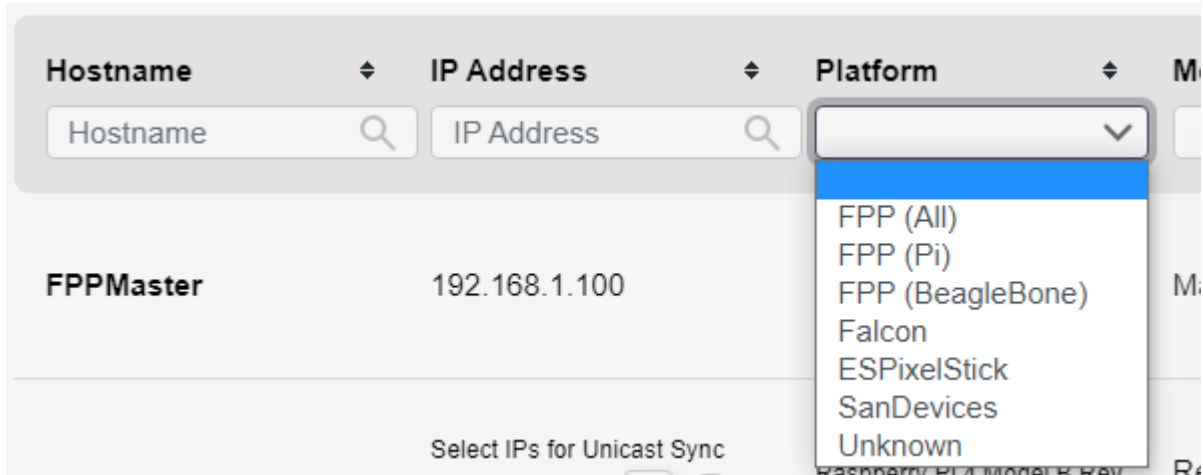

The MultiSync section contains useful information on all of the discovered FPP devices in your network.

- Hostname- This will list the Hostname of all of your discovered FPP devices. The current device will be noted in bold text. **If you have more than one device with the same Hostname, the display might not be accurate.**
- IP Address- This will list the associated IP address(es) for the FPP Devices. In the case that an FPP device has more than one network configured, it will list all of the networks. If you are on a system set to Player Mode with MultiSync enabled, your Remote FPPs will have a checkbox next to them if you need to configure them for Unicast Sync. Multicast Sync is the recommended method if your network equipment supports IP Multicast and IGMP Snooping. If your home network does not have these features then you may get better results with Unicast  
The IP addresses are hyperlinks that will take you to the associated FPP device if clicked. **If you have more than one FPP device with the same Hostname, then the display might not be accurate.**
- Platform- This will show what SBC the FPP is installed on including the model and other information.
- Mode- This will show the FPP mode that each device is running.
- Status- This shows the current Status of the FPP Device. If it is playing a sequence, then it will show the sequence that is playing.
- Elapsed- If a sequence is playing it will show how much time has elapsed on the sequence on the Master and Remotes. If the FPP is in Bridge Mode, then it will show that it is bridging.
- Version- This indicates the FPP branch, version and OS that is installed on this FPP.
- Git Version- This will show the status of your FPP software. It will have a visual indicator of the status. Red text indicates that an upgrade is available, green text indicates that it is up to date and black text indicates that the reporting device couldn't report if it was up to date (this is usually due to a network configuration error)
- Auto Refresh stats of FPP Systems- Selecting this option will refresh the screen every 2 seconds.

There are additional options available by clicking the Settings button and will allow you to select different options for how the devices will be displayed and some additional functionality.

Send MultiSync Packets	<input checked="" type="checkbox"/>	?
Send MultiSync to ALL remotes via Multicast (239.70.80.80)	<input checked="" type="checkbox"/>	?
Send MultiSync to ALL remotes via Broadcast	<input type="checkbox"/>	?
MultiSync Unicast Discovery IPs (CSV list)	<input type="text"/>	
HTTP Discovery IPs & subnets (CSV list)	<input type="text" value="192.168.101.2/32"/>	
Hide 10.x.x.x/8 Subnets in systems list	<input type="checkbox"/>	?
Hide 172.16.x.x/12 Subnets in systems list	<input type="checkbox"/>	?
Hide 192.168.x.x/16 Subnets in systems list	<input type="checkbox"/>	?
<b>- Advanced Level Setting</b>		

- Send MultiSync Packets- This option is available if this FPP is set to Player mode. Enabling this option will configure this device to send out MultiSync packets to FPP devices configured as a Remote.
- Send MultiSync to all Remotes via Multicast- This option is available if this FPP is set to Player mode. Enabling this option will configure this device to send out MultiSync packets using IP Multicast.
- Send MultiSync to all Remotes via Broadcast- This option is available if this FPP is set to Player mode. Enabling this option will configure this device to send out MultiSync packets using network Broadcast.It is helpful for networks that don't support IP Multicast and IGMP Snooping
- MultiSync Unicast Discovery IPs (CSV list):- This is used for FPP instances/controllers that are not discoverable through the normal FPP multisync discovery process. (\* **This is only visible with an Advanced or higher level setting in the UI tab.**)
- HTTP Discovery IPs & subnets- You can enter the IP address of devices that are in a different subnet than the FPP device in order to get the information on the MultiSync page. (\* **This is only visible with an Advanced or higher level setting in the UI tab.**)
- Hide 10.x.x.x/8 Subnets in system list- You can hide subnets in the private 10.0.0.0/8 IP space from the list. This can be useful if you have an FPP device connected to a show network and your home network and you only want to display your show network devices. (more of a developer option)
- Hide 172.x.x.x/12 Subnets in system list- You can hide subnets in the private 172.16.0.0/12 IP space from the list. This can be useful if you have an FPP device connected to a show network and your home network and you only want to display your show network devices. (more of a developer option)
- Hide 192.168.x.x/16 Subnets in system list- You can hide subnets in the private 192.168.0.0/16 IP space from the list. This can be useful if you have an FPP device connected to a show network and your home network and you only want to display your show network devices. (more of a developer option)

\* As of the writing of this manual, the Falcon Controllers (in remote mode) do not support the Multicast format but this should be fixed in a future update to the Falcon Controller. Also, not all home networking equipment supports Multicast.

There are additional actions that can be utilized with the Action section of the MultiSync page:

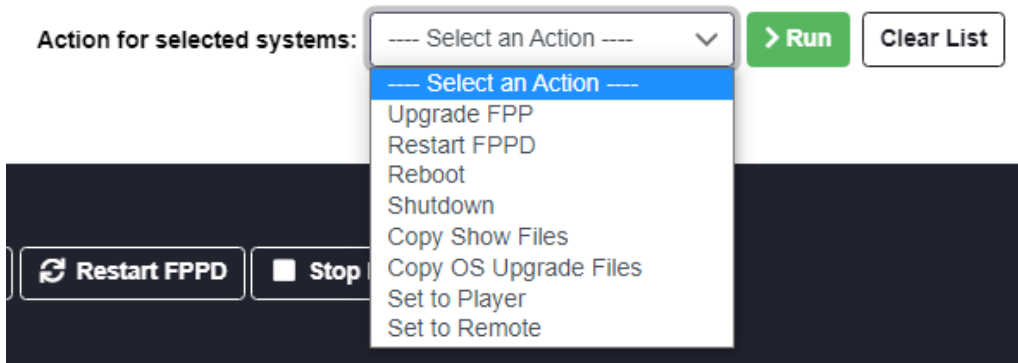

On the far right of the screen are check boxes for you to select which device(s) you want to take an action on. Those actions are:

- Upgrade FPP- you can upgrade the software on any or all of your devices at the same time from this screen.

If the FPP software is not up to date, it will display it in red, otherwise it will be green. If the FPP device is unable to determine the Git Version, it will display in black (this usually indicates that there is a networking configuration problem, most often a DNS server issue) You can update one or several of the FPP devices at the same time from this screen by selecting the devices and the Upgrade FPP option and clicking the Run button.

When the devices are updating you can see a progress screen. When completed, you can Reboot or Restart FPPD.

Hostname	IP Address	Platform	Mode	Status	Elapsed	Version	Git Versions	Utilization
FPPMaster	192.168.1.100	Raspberry Pi Raspberry Pi 3 Model B Rev 12	Master	Idle		FPP: 5.x-master-319-g4ff9086b OS: v4.2	Local: 4ff9086 Remote: 81f804d Branch: master	CPU: 25% Mem: 14% Uptime: 1 day
FPP-Pi4Test	192.168.1.250	Raspberry Pi Raspberry Pi 4 Model B Rev 1.1	Player	Idle		FPP: 5.x-master-295-gaee003c5 OS: v5.0-alpha	Local: aee003c Remote: 81f804d Branch: master	CPU: 16% Mem: 13% Uptime: 8.09
FPP-BB-Test	192.168.1.251	BeagleBone Black TI AM335x BeagleBone Black	Remote	Idle		FPP: 5.x-master-310-g77bad4c8 OS: v5.0-alpha	Local: 77bad4c Remote: 81f804d Branch: master	CPU: 100% Mem: 24% Uptime: 1 day

- Restart FPPD- You can restart the FPPD on any or all of your devices at the same time from this screen. This restarts the FPP software without a full OS reboot.
- Reboot- This will do a full OS reboot of the FPP selected device(s)
- Shutdown- This will shut down the selected device(s).
- Copy Show Files- You can copy show files from this FPP device to other FPP devices. You can't individually select which files are uploaded, it will copy all files of the type selected to the FPP(s) selected. Be careful with copying sequences because there are some sequences that are only compatible with the device they are stored on.
  - Compress FSEQ Files- If this box is checked, FPP will compress the FSEQ files before sending them to the remotes. This is primarily for older V1 FSEQ

files that are not compressed by the sequencer (xLights, Vixen, etc.) Newer V2 FSEQ files are typically compressed already and don't need to be compressed again.

### Copy Files

- Copy Sequences ?
- Copy Effects ?
- Copy Music ?
- Copy Videos ?
- Copy Events ?
- Copy Scripts ?
- Compress files during copy to Remotes to speed up file sync process ?

- Copy OS Upgrade Files- You can copy .fppos files (OS Upgrade files) from this FPP device to other FPP devices. The copy function will only copy the files that are appropriate for the platform. (Pi .fppos files will not get uploaded to BB based systems, and vice versa.)
- Set to Player- This will set the Mode to Player for the selected device(s).
- Set to Remote- This will set the Mode to Remote for the selected device(s).

**Note: [FPP Connect](#) in xLights is a more robust method of uploading files to your FPP devices. FPP connect can upload files in the sparse format which will reduce the file sizes tremendously. FPP connect can also configure your inputs and outputs and other settings as well.**

## FPP Settings

This page is to set up some administrative functions and settings. The settings are organized by function to ease navigation.

**The FPP Settings page will display differently depending on your user level.**

The screenshot shows the 'FPP Settings' interface. At the top right, there is a 'Status/Control' dropdown menu. Below it is a horizontal navigation bar with tabs for 'Playback', 'Audio/Video', 'Time', 'UI', 'Email', 'MQTT', 'Privacy', 'Input/Output', 'Logging', 'Storage', 'System', and 'Developer'. The 'Playback' tab is selected and highlighted in red. Under the 'General Playback' section, there are three settings: 'Blank between sequences' with an unchecked checkbox and a help icon; 'Pause background effects during FSEQ playback' with an unchecked checkbox and a help icon; and 'Remote Media/Sequence Offset' with a text input field containing '0' and a unit 'ms' and a help icon. At the bottom, there is a legend for setting levels: a blue icon for 'Advanced Level Setting', a green icon for 'Experimental Level Setting', and a red icon for 'Developer Level Setting'.

# Playback

The Playback setting is used to configure general playback settings.

**The Playback Settings page will display differently depending on your user level.**

- Blank between sequences-This setting will send out blanking data to turn the pixels off when a sequence finishes. If you want a looping sequence where the pixels don't turn off or "blink" between loops this should remain unchecked. Otherwise, checking this box will tell FPP to force all pixels off at the end of each sequence.
- Pause Background Effect Sequence during FSEQ playback- Effect sequences take priority over FSEQ files. Select this option if you have Background Effect Sequences and you want the FSEQ file to take priority over the Background Effect Sequence.
- Open/Start Delay- This will add a delay from the opening command from the Master to the actual start of the sequence. This can be helpful when opening videos or other media on remote devices that need extra time to load and begin playing media files.  
(\* This is only visible with an Advanced or higher level setting in the UI tab.)

# Audio/Video

The Audio/Video tab is used to configure your general audio and video settings. Many of the settings will be configured based on the FPP device and attached hardware.

**The Audio/Video Settings page will display differently depending on your user level and hardware.**

Playback Audio/Video Time UI Email MQTT Input/Output

### General Audio/Video

Audio Output Device  ?

Audio Output Mixer Device  ?

Audio Output Format  ?

Default Video Output Device  ?

Media/Sequence Offset  ms ?

Disable IP announcement  ?

- Audio Output Device- You can select which device you want to play your audio. If you do not have any audio devices installed, like a SoundBlaster, then you will only have the option of the onboard audio device. The BeagleBone SBC does not have onboard audio and if no audio device is installed, it will indicate Dummy. If you have a

Raspberry Pi then you will have the option of bcm2835 ALSA. The Pi onboard audio will output the sound to the 3.5mm audio jack on the Pi.

**Note: if you are using a Pi with a Hat or Cape, then the onboard audio is disabled and will indicate Dummy unless you have a USB Audio device attached like a SoundBlaster Play 3.**

- Audio Output Mixer Device- FPP will identify the available installed output devices and provide the option to select which device you want to output the audio. It will be set to the default for the FPP device. For the Pi, it will be PCM, the BeagleBone SBC does not natively have an audio device so it will be blank. If you have a SoundBlaster Play 3 or similar device this should normally be set to 'speaker'.
- Audio Output Format- You can select a specific sampling rate and device, normally the default works the best. But if you need a specific sampling rate, you can select the rate that matches your audio.  
**(\* This is only visible with an Advanced or higher level setting in the UI tab.)**
- Default Video Output Device- If you are using your FPP to directly play a video, then you can select which device you want the video to play on. You can select the HDMI output port or you can select a Pixel Overlay model which is usually a P10/P5 panel display or Virtual Matrix.
- Media/Sequence Offset- This setting is used to synchronize the media to the sequence. This can be used if your FM transmitter or other audio processing device(s) creates a consistent lag in the broadcast (this is rare, but it does happen). This can also be used to fine tune the synchronization in a Master/Remote configuration where there is consistent network delay between Master and Remote. (e.g. if you are using a Wi-Fi extender to reach an FPP remote that is far away from the Master and has additional network delay because of the extender)  
**(\* This is only visible with an Advanced or higher level setting in the UI tab.)**
- Disable IP announcement- When the Raspberry Pi boots up, it will announce its IP address over the audio device. If you do not want this announcement, then select this option.
- Ignore Media Sync Packets- You can select this option on a FPP device in Remote mode and if the Media Sync Packets are ignored, then the remote will start and stop the video when queued but it will not attempt to keep in sync with the master. The video might play smoother but could become out of sync with the Master. **(\* This is only visible with an Advanced or higher level setting in the UI tab and the device is set to Remote Mode.)**

## Time

This tab is used to configure your time and location settings. If you want your Playlists to automatically start at scheduled times, then the FPP that is scheduling the show has to be configured to keep accurate time (not the remotes or other devices). If your FPP doesn't have access to the internet, then you can manually set the date and time. If your FPP device ever gets shut down or rebooted and it doesn't have a Real Time Clock or access to the internet, then the time will reset.

## Time Config

Current System Time

Thu Jul 8 09:11:39 MDT 2021

Set Date

(YYYY-MM-DD) ?

Set Time

(HH:MM:SS) ?

Real Time Clock

None



NTP Server



Time Zone

America/Boise

[Lookup Time Zone](#)

- Current System Time- This will show your current System date and time and the configured Time Zone.
- Set Date – You can manually set the date if your FPP device doesn't have a network connection.
- Set Time – You can manually set the time if your FPP device doesn't have a network connection.
- Real Time Clock-If you have a Cape/Hat attached that has a Real Time Clock (RTC), you can select the Cape/Hat from the drop down list. (FPP will attempt to identify the attached cape and load that device.) Once you select the correct Hat/Cape, you will need to reboot the FPP device and then set up the time from this page.
- NTP Server- If you want a different Time server than the default then you can enter the IP address of the Time Server you want to use. You should normally keep the NTP Server blank.
- Time Zone- If you are using a Network Time Protocol server to keep the current Date/Time, then you will need to select your time zone so that your FPP can adjust the time accordingly.
- Lookup Time Zone- You can click this button to lookup your current Time Zone. Depending on your network provider, you might get incorrect results.

## UI

The UI settings page will allow you to change the appearance of the User Interface (UI)  
**The UI Settings page will display differently depending on your user level.**



## User Interface

User Interface Level  ?

Display all hardware options/settings  ?

Disable restart/reboot UI Warnings  ?

Date Format  ?

Time Format  ?

Temperature display units  ?

## UI Colors

Header Background Color  ?

Color Pair 1-A  ?

Color Pair 1-B  ?

Color Pair 2-A  ?

Color Pair 2-B  ?

Color Pair 3-A  ?

Color Pair 3-B  ?

Color Pair 4-A  ?

Color Pair 4-B  ?

## UI Password

Enable UI password  ?

## User Interface

- User Interface Level- There are 4 User Interface levels that are designed to display only the information needed for the user level in order to make navigation easier and to remove unneeded clutter from the screen. Those levels are:
  - Basic- This will give you access to all of the needed settings, configurations etc. that most users will need.
  - Advanced- This will give you access to some of the Advanced features/settings in FPP. The Advanced user level can be helpful for people that have unusual configurations that need further configuration or need access to some advanced features that most users don't use.
  - Experimental- This will give you access to some settings/configurations that are in the testing phase and need more testing before being moved to one of the other levels. Making changes to settings/configurations in the Experimental UI level might not work properly until fully tested.
  - Developer- This will give you access to some settings/configurations normally used by the developers for testing. Making changes to settings/configurations in the Developer UI level might create problems if configured incorrectly.



- Display all hardware options/settings- By default, FPP will only display the options/settings based on the device and hardware that has been detected to eliminate the display of settings that are incompatible with the device or not used. Selecting this option will display all options/settings for all devices-even if they are not connected. If this option is selected, you will be able to make changes to settings that could cause problems or unexpected results.  
**(\* This is only visible with an Advanced or higher level setting in the UI tab.)**
- Disable restart/reboot UI Warnings- This will disable the reboot and/or restart warnings when a setting has changed. This is used for developer testing and if you disable it, you might not be warned when a reboot/restart is required and your results might not be what you expected.  
**(\* This is only visible with a Developer level setting in the UI tab.)**
- Date Format- You can select the format of how you want your date to display.
- Time Format- You can select the format of how you want the system time to display.
- Temperature Display Units- You can select if you want the temperature to display in either Fahrenheit or Celsius.

## UI Colors

You can configure some of the User Interface colors in this section.

- Header Background Color- You can select the Header Background color of the user interface (webpage). This could be helpful if you have several devices and you want some visual clue which FPP device you are working on.

### Default

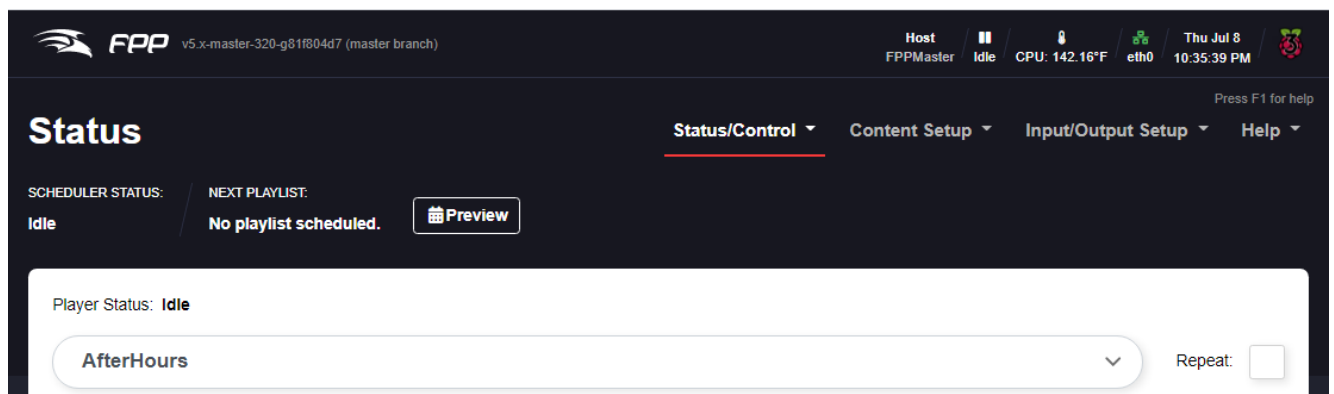

### Blue

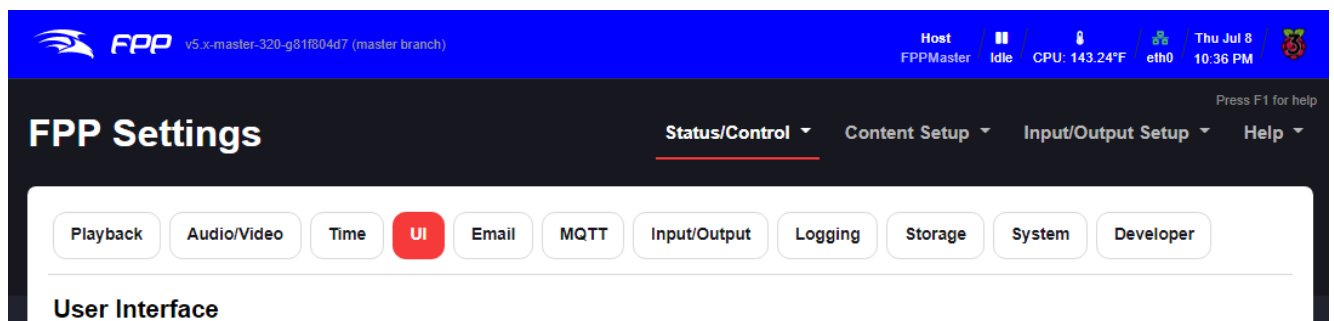

- Color Pairs- This is to set the colors used in tables to identify different sections like in the Schedule Preview. It makes it easier to identify scheduling problems.

TIME	ACTION	ARGS
Thu Jul 8 @ 09:48 PM	Start Playing	Christmas 2020 Day 1 (Repeating w/ Graceful Stop)
Thu Jul 8 @ 12:00 PM	Start Playing	Christmas 2020 Day 3 (Repeating w/ Graceful Stop)
Thu Jul 8 @ 10:00 PM	Start Playing	AfterHours (Repeating w/ Graceful Stop)
Thu Jul 8 @ 11:00 PM	End Playing	Christmas 2020 Day 3 (Graceful Stop)
Fri Jul 9 @ 12:00 AM	Start Playing	Christmas 2020 Day 1 (Repeating w/ Graceful Stop)
Fri Jul 9 @ 02:00 AM	End Playing	AfterHours (Graceful Stop)
Fri Jul 9 @ 12:00 PM	End Playing	Christmas 2020 Day 1 (Graceful Stop)
Fri Jul 9 @ 09:47 PM	Start Playing	Christmas 2020 Day 2 (Repeating w/ Graceful Stop)
Fri Jul 9 @ 09:48 PM	Start Playing	Christmas 2020 Day 2 (Repeating w/ Graceful Stop)
Fri Jul 9 @ 10:00 PM	Start Playing	AfterHours (Repeating w/ Graceful Stop)
Fri Jul 9 @ 11:00 PM	End Playing	Christmas 2020 Day 2 (Graceful Stop)
Sat Jul 10 @ 12:00 AM	Start Playing	Christmas 2020 Day 1 (Repeating w/ Graceful Stop)
Sat Jul 10 @ 02:00 AM	End Playing	AfterHours (Graceful Stop)
Sat Jul 10 @ 12:00 PM	End Playing	Christmas 2020 Day 1 (Graceful Stop)
Sat Jul 10 @ 12:00 PM	Start Playing	Christmas 2020 Day 3 (Repeating w/ Graceful Stop)
Sat Jul 10 @ 09:47 PM	Start Playing	Christmas 2020 Day 3 (Repeating w/ Graceful Stop)
Sat Jul 10 @ 10:00 PM	Start Playing	AfterHours (Repeating w/ Graceful Stop)
Sat Jul 10 @ 11:00 PM	End Playing	Christmas 2020 Day 3 (Graceful Stop)
Sun Jul 11 @ 12:00 AM	Start Playing	Christmas 2020 Day 1 (Repeating w/ Graceful Stop)
Sun Jul 11 @ 02:00 AM	End Playing	AfterHours (Graceful Stop)
Sun Jul 11 @ 12:00 PM	End Playing	Christmas 2020 Day 1 (Graceful Stop)
Sun Jul 11 @ 09:47 PM	Start Playing	Christmas 2020 Day 1 (Repeating w/ Graceful Stop)
Sun Jul 11 @ 10:00 PM	Start Playing	AfterHours (Repeating w/ Graceful Stop)
Sun Jul 11 @ 11:00 PM	End Playing	Christmas 2020 Day 1 (Graceful Stop)
Mon Jul 12 @ 12:00 AM	Start Playing	Christmas 2020 Day 1 (Repeating w/ Graceful Stop)

- **Enable UI Password-** By default, there is no password required to access FPP via the web interface. **Changing the password is only for advanced users as it could cause some of the functionality of FPP to be disabled without additional formatting.** It is not usually required to set up a UI password because the UI can only be reached from a computer that has access to your local network. You can set up a user password to access the UI. The password has to be at least 8 characters. Once the password is set, you will have to use the username of admin and the password you set to access any of the screens.

## Email

You can set up an email account in FPP to use for sending information to an email account by using a script.

## Outbound Email Configuration

SMTP Server Hostname





Once you enter your SMTP Server Hostname and either hit “enter” or the tab key, you will get some additional options that you will need to configure.

## Outbound Email Configuration

SMTP Server Hostname



SMTP Server Port



SMTP Server Login



SMTP Server Password



From Email Address



From Name



Default TO Address





- SMTP Server Hostname- This is the SMTP Server that your email client uses.
- SMTP Server Port- Port 587 is the most common port used but 465 and 25 are used sometimes.
- SMTP Server Login- This is typically your Email address that you are using to send out the email.
- SMTP Server Password- This is the password used for the email account you are using to send out the email.
- From Email Address- This is the email address that you are using to send out your email.
- From Name- You can enter a Name that will show as the sender of the email. You could use the FPP HostName to identify which FPP device is sending the email.
- Default TO Address- This will be the address that you want the email to be sent to. This might be the same as the From address if you only have one email account.

Configure Email- Click this button to save your settings.

Send Test Email- Click this button to test your email settings.

Note: Some email clients have security settings that will block outside clients from sending email (like gmail or Yahoo) so you might have to change your security settings to allow 3<sup>rd</sup> party access to your email account.

## MQTT

This section is used to set up MQTT settings if you are going to automate your FPP with an MQTT server such as a home automation system.

Playback

Audio/Video

Time

UI

Email

MQTT

Input/Output

L

### MQTT

Broker Host



For more info [Press F1 for more details](#)

Once you enter in your Broker host (either IP address or HostName) and hit the Enter key, you will get more options to fill out.

### MQTT

Broker Host

192.168.1.25



Broker Port

1883



Client ID



Topic Prefix



Username



Password



CA File



Publish Frequency

0



Subscribe Topic (optional)



For more info [Press F1 for more details](#)

- Broker Host- This is the HostName or IP address of your MQTT Broker
- Broker Port- This is the TCP port number that your MQTT Broker is listening to.
- Client ID- If this is not set, your MQTT host will create one.

- Topic Prefix- Enter the Topic Prefix to be used when sending messages to the MQTT Broker.
- Username- This is the Username to authenticate with the MQTT Broker.
- Password- This is the Password to authenticate with the MQTT Broker.
- CA File- This is an optional CA file to authenticate the MQTT Broker's certificate. This is only required when using SSL encryption and self-signed certificates.
- Publish Frequency- Optional Frequency to publish FPP status to the MQTT Broker. If this is set to zero, then it will only publish on demand.
- Subscribe Topic- You can configure an MQTT topic to subscribe to, for all topics use # or you can filter it by using something like smarthings for all smarthings related topics.

## Privacy

FPP has some settings that can be configured if privacy is a concern. The developers are very cautious about privacy and allow you to customize these settings.

**Privacy**

Share Statistics Enabled ?

Fetch cape logos from vendors ✓ ?

Send cape serial numbers to vendors ✓ ?

[Preview Statistics](#)

Clicking the [Preview Statistics](#) button will show you the information that is getting reported to the developers so you can see what is being shared if you enable the [Share Statistics](#) option. It is recommended to enable this option to help the developers improve FPP and its performance.

Share Statistics- FPP will gather anonymous statistics about your FPP device and the way it is used such as what SBC is being used, what Plugins are installed, what version of FPP is being used, etc. This will help the developers to create a better FPP. This data has no personal identifying information in it and you can see exactly what is being sent by clicking on the [Preview Statistics](#) button. There are 3 options available.

- Enabled- This will send the statistics to the developers.
- Disabled- This will not send any statistics to the developers.
- Banner- This will display a banner on the Status page asking you to enable the statistics.

The recommended setting is Enabled.

Fetch cape logos from vendors- A vendor can include a logo in the header of FPP but due to the limitations of eeproms, this logo has to be downloaded from their website. This could expose your IP address to the vendor. This normally isn't a big risk but available if you want to change it.



Send Cape serial numbers to vendors- A vendor can have the serial number of their cape sent to them which could potentially identify you based on your purchase history and information given to the vendor previously. This typically isn't a security issue but available if you want to change it.

## Input/Output

This section is only available if you have the user level setting set to Advanced or above and is used to configure some global input/output settings.





### Input Control



 Disable Network Bridge Monitoring (E1.31/DDP/ArtNet)  

Command Preset Control Channel  

Bridge Data Priority  

### Output Control

 Always transmit channel data  

 E1.31 Bridging Transmit Interval  

#### Input Control-

- Disable Network Bridge Monitoring- You can disable the Bridge Monitoring function. This is beneficial for those that want to develop their own bridge listener solution.
- Command Preset Control Channel- This is the channel that will activate your command presets, refer to [Command Presets](#) for more information.
- Bridge Data Priority- You can set the priority that FPP uses in processing the Bridge Data
  - Prioritize Bridge- With this option, FPP will override any playing sequences and use the incoming Bridge data.
  - Prioritize Sequence- With this option, FPP will override any Bridge data and play sequences. If there are no sequences playing, then the Bridge data will be used. This is probably the setting that you would want if you are in the show season so that you don't accidentally interrupt your show.
- Always transmit channel data- This setting forces transmission of channel data out to controllers whenever FPP is running. FPP will normally only transmit data when there is a sequence playing or a Pixel Overlay model is enabled. Some older controllers go into test mode when not receiving data. This setting causes FPP to always send data so the controllers do not go into test mode. It is not recommended to set this unless you are using one of the older controllers that need this setting.

- E1.31 Bridging Transmit Interval- This setting allows for a different timing interval when operating in Bridge mode. The default is 50ms and it is recommended to keep this setting. **Warning- some devices do not support rates other than 50ms.**

## Logging

This page is used to set the logging criteria for your FPP device. FPP creates several logs that can be beneficial for troubleshooting your system if something isn't working correctly. Normally this should be configured for Info level of logging unless you need to troubleshoot something. You can select specific areas to set the log levels depending on the problem you are trying to identify.



**Note:**

It is recommend that the Log Level be set to **Info** on production systems

### Log Levels

General	Info	?
ChannelOut	Info	?
ChannelData	Info	?
Command	Info	?
Control	Info	?
E131Bridge	Info	?
Effect	Info	?
GPIO	Info	?
HTTP	Info	?
MediaOut	Info	?
Playlist	Info	?
Plugin	Info	?
Schedule	Info	?
Settings	Info	?
Sequence	Info	?
Sync	Info	?

**Bulk Change Log Level**





Log Levels- There are five different levels of logging that can be configured depending on the problem you are trying to fix. **It is not recommended to change this to anything other than info unless requested by the development team for advanced troubleshooting or you are an advanced user.**

- Errors Only- This will only log items that are identified as errors for the section selected.
- Warn- This lists only the items that have been identified as a warning.
- Info- This setting will include the basic information needed for most troubleshooting or provide information on what section might need to be addressed to find the problem.. This is the recommended setting for production systems..
- Debug- This setting will include all of the Info level messages and include the debugging level messages. It is not recommended to use the Debug Log Level unless requested by the development team for advanced troubleshooting.
- Excessive- This setting will include all log messages. It is not recommended to use the Excessive Log Level unless requested by the development team for advanced troubleshooting. Using the Excessive Log level will potentially create log files that are excessively large and could impact performance.

## Storage

This section is only available if you have the user level setting set to Advanced or above and is used to configure the location to store your sequences and other media files.

It is not recommended to use any other method of storage than the uSD card because other devices such as a USB drive have been shown to cause lags and other problems in the playback of a show. USB storage used to be the preferred method of storing your media files but many changes have been made in both xLights and FPP so that the best method of storing your settings and media is on the SD card. There are also advanced backup methods that make using a USB drive for storage obsolete.



Storage Device: mmcblk0p1 - 29.8GB (25.9GB Free) (boot device) ▼

Changing the storage device to anything other than the SD card is strongly discouraged. There are all kinds of problems that using USB storage introduce into the system which can easily result in various problems include network lag, packet drops, audio clicks/pops, high CPU usage, etc... Using USB storage also results in longer bootup time. In addition, many advanced features and various capes/hats are known to NOT work when using USB storage.

In addition to the above, since it is not recommended, using USB storage is not tested nearly as extensively by the FPP developers. Thus, upgrades (even "patch" upgrades) have a higher risk of unexpected problems. By selecting a USB storage device, you assume much higher risk of problems and issues than when selecting an SD partition.

### eMMC Actions:

Flash to eMMC

\* This will copy FPP to the internal eMMC.

Flash to eMMC

\* This will copy FPP to the internal eMMC, but use BTRFS for the root filesystem. BTRFS uses compression to save a lot of space on the eMMC, but at the expense of extra CPU usage.

eMMC Actions- If you are using a BeagleBone Black or Green then your device will have on-board eMMC memory and you can select to have the operating system copied to the eMMC. This is not normally the recommended method. You can select the standard storage method or the BTRFS method but it uses a compression algorithm that could slow the FPP device down slightly. (**\* This is only visible with an Advanced or higher level setting in the UI tab.**)





# System

The System tab is used to configure some of the system wide settings. This will look different depending on the SBC that you are using and the hardware on that board.

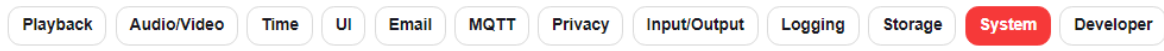
## Raspberry Pi System Page



### System Settings

FPP Player Mode	Player <input type="button" value="v"/> ?
Send MultiSync Packets	<input checked="" type="checkbox"/> ?
 Disable Scheduler	<input type="checkbox"/> ?
 Granular Scheduling	<input type="checkbox"/> ?
 ArtNet Time Code Sync	<input type="checkbox"/> ?
Locale	USA <input type="button" value="v"/> ?
Blank screen on startup	<input type="checkbox"/> ?
Force HDMI Display	<input type="checkbox"/> ?
Force HDMI Resolution	Default <input type="button" value="v"/> ?
Status Display	Disabled <input type="button" value="v"/> ?
FPPD Boot Delay	0s <input type="button" value="v"/> ?

### Geographic Location

Latitude	<input type="text" value="43.6502"/> ?
Longitude	<input type="text" value="-116.4343"/> ?

### Kiosk Frontend

The Kiosk frontend installs a bunch of extra packages and sets up Chrome running on the local HDMI port to allow FPP to be configured and monitored from a keyboard and mouse connected to the Pi's USB ports. The additional packages take up about 400MB of space.

# BeagleBone System Page

Playback Audio/Video Time UI Email MQTT Privacy Input/Output Logging

## System Settings

FPP Player Mode	Player ?
Send MultiSync Packets	<input type="checkbox"/> ?
Disable Scheduler	<input type="checkbox"/> ?
Granular Scheduling	<input type="checkbox"/> ?
ArtNet Time Code Sync	<input type="checkbox"/> ?
Locale	USA ?
Status Display	128x64 2 Color I2C (SSD1306) ?
FPPD Boot Delay	0s ?

## BeagleBone LEDs

USR0	Heartbeat ?
USR1	SD Card Activity ?
USR2	CPU Activity ?
USR3	eMMC Activity ?
Power	Enabled ?

## Geographic Location

Latitude	43.578 ?
Longitude	-116.2954 ?

Lookup Location Show On Map

FPP Mode- This allows you to change the FPP Mode. There are 2 Modes that FPP can run in:

1. Player-This setting is used when this FPP is going to be a player by itself or sending sequence data to other controllers. If the Player is going to communicate with other controllers then there are two ways to send data to the Remote FPP devices.
  - a. You can configure the FPP device in Player mode to output E1.31/DDP/ArtNet data to other controllers or FPP devices as needed. This will send the pixel data frame by frame to all of the Remotes/controllers. This is commonly used if you are connected to a wired network and controlling one or many other controllers. If you are going to send data (DDP, E1.31 etc.) to the rest of your controllers then you will also need to have the appropriate Channel Outputs setup.
  - b. You can also configure the Player mode to output MultiSync packets. This setting is used if you are going to have more than one FPP device and you want them to all be synchronized via small sync packets. The Player will need a copy of the sequences (.fseq) and media (music/video) files. The Player will also be where your Playlists and Schedules are created.
2. Remote- This Mode is used if you are going to synchronize this FPP and attached controller to a Player FPP. This can be done two ways:
  - a. MultiSync- The remote will listen for MultiSync packets from a Player FPP and will sync its output with the Player FPP. The Remote will need a copy of all the sequences (.fseq) that are going to be played. You will also need to have the appropriate Channel Outputs setup. Refer to the [MultiSync/Remote](#) section for more information.

- b. E1.31/DDP/ArtNet- This configuration is used if your remote is going to receive E1.31/DDP/ArtNet data. This will require that the E1.31/DDP/ArtNet inputs have been configured. Refer to the [Standalone](#) and [Wired Separate Show Network](#) sections for more information.

Disable Scheduler- You can disable the scheduler by selecting this option. This is helpful so that you don't have to go into your scheduler and manually deactivate all of your schedules. (**\* This is only visible with an Advanced or higher level setting in the UI tab.**)

Granular Scheduling- This will give you the ability to create schedules down to the second, otherwise it will be down to the minute. (**\* This is only visible with an Advanced or higher level setting in the UI tab.**)

ArtNet Time Code Sync- This will enable FPP to listen for ArtNet Sync packets and sync a playlist named "artnet-sync-playlist." (**\* This is only visible with an Advanced or higher level setting in the UI tab.**)

Locale- The locale setting is used to configure some region specific settings such as Holidays to be used in the Scheduler.

Blank Screen on Startup- By default the FPP will display system data to the HDMI port when it boots up and will remain until other data is sent out to the HDMI port. The screen blanking will turn the text console off after one minute so that it does not remain on the monitor. If you are using this FPP to play video through the HDMI port, then you probably want to enable this setting. (**This option is only available on Pi based FPP devices as the HDMI port is disabled on BeagleBone based systems**)

Force HDMI Display- On the Raspberry Pis, if the HDMI port is not connected on boot up it won't detect the HDMI device. If you power on your devices at the same time, the Pi might not detect the connected HDMI device. If you select this setting, the Pi will always try to output to the HDMI port even if it wasn't detected at boot up. (**This option is only available on Pi based FPP devices as the HDMI port is disabled on BeagleBone based systems**)

Force HDMI Resolution- You can configure a resolution for your HDMI output. By default, FPP will use the settings that the monitor reported at the boot up. (**This option is only available on Pi based FPP devices as the HDMI port is disabled on BeagleBone based systems**)

Status Display- If you connect an OLED screen to the I2C bus of the FPP device, you can configure the device here. This will usually get auto-populated on boot up if one is installed. The display will give you some basic information on your device such as IP addresses, status and sequence that is playing. Several different models of OLED screen are supported and you use this setting to select which model you have.



FPPD Boot Delay- You can add a delay to booting up the FPP. This is helpful if you power down all components in your show, like routers and switches, and turn them on all at the same time. FPP could start before the routers and/or switches have had a chance to fully initialize which can cause communication errors. If you are not powering down your routers and/or switches, then leave the default setting of 0s.

BeagleBone LEDs-The BeagleBone series of SBCs have 4 LEDs on the board and the function of each can be controlled or turned off. You can change the default settings for the LEDs, the most common change is to disable them if the lights might be distracting. It is recommended to keep the defaults. (**\*This option is only available on BeagleBone based FPP devices.**)

Geographic Location- If you want to use the Sunrise or Sunset option of scheduling your Playlist to start or end, then you will need to enter your location in Latitude and Longitude. You can get this information by clicking on the Lookup Location button, but depending on your internet provider, this information could be incorrect, so verify if you use this option. You can also get your information by entering your address into LatLong.net or GoogleMaps.com. If you use Google Maps, then after you enter your address, the Latitude and Longitude will be in the address bar after the @ symbol. The Latitude is listed first and then the Longitude. Make sure to use the – sign if it is indicated. You can double check the entry by clicking on the View Location button and verify that the coordinates are correct.

Kiosk Frontend- This can be used if you want the FPP device to be fully standalone but requires that you have a monitor and keyboard connected to your Pi (this won't work on a BeagleBone based system.) This is not a normal configuration.  
**(\* This is only visible with an Advanced or higher level setting in the UI tab.)**

## Developer

The developer tab is only available with a UI Level of Developer. This section is useful if you want to switch FPP versions or other developer testing.

### Developer Settings

UI Platform Masq: Default

Git Branch: master

**Note:** Changing branches may take a couple minutes to recompile and may not work if you have any modified source files.  
**WARNING:** Switching branches will run a "git clean -df" which will remove any untracked files. If you are doing development, you may want to backup the source directory before switching branches using this page.

Git Status:

**Reset Local Changes**

**WARNING:** Resetting local changes performs a "git reset --hard HEAD" to revert all local source code changes

On branch master  
Your branch is up to date with 'origin/master'.  
nothing to commit, working tree clean

FPP Rebuild

**Rebuild FPP**

**WARNING:** This recompiles the local source code

UI Platform Masq- When FPP boots up, it will auto detect the FPP device and only display settings that are relevant to your device. If you are developing Plugins or other

functionality and want to see the options, then you can change the Platform mask to display the options based on that platform. Be careful making changes while in this mode as it could have an adverse effect on your FPP device.

**Git Branch-** You can change which version of FPP you want to use with this setting. This setting is useful if you want to upgrade to the Master Branch where the latest improvements have been implemented prior to the official release. Note that some upgrades require an OS rebuild so you might not get all of the benefits of the Master Branch without upgrading the OS. (refer to the [Upgrade FPP](#) section)

**Reset Local Changes-** If you have manually changed the code in FPP, then clicking this button will revert the code back to the original code.

**Git Status-** This will show you the status of your local FPP version.

**FPP Rebuild-** This will recompile all of the FPP files and is useful if you interrupted the installation process or otherwise corrupted the FPP files.

## FPP Backup

FPP has several backup options available. You can update just your configuration files through the JSON Configuration Backup or your configuration and all relevant files through the File Copy Backup. This can be useful in restoring your FPP device.

### JSON Configuration Backup

The JSON Configuration Backup will save all or a portion of your different settings and store them on your computer to restore at a later time. This will only save the selected configuration files; it will not save sequence files, audio files, etc.

The screenshot shows the 'FPP Backups' web interface. At the top, there are navigation tabs: 'Status/Control' (selected), 'Content Setup', 'Input/Output Setup', and 'Help'. Below the tabs, there are two buttons: 'JSON Configuration Backup' (highlighted in red) and 'File Copy Backup'. The main content area is divided into two sections: 'Backup Configuration' and 'Restore Configuration'. In the 'Backup Configuration' section, there is a 'Protect sensitive data?' checkbox which is checked with a green checkmark. Below it is a 'Backup Area' dropdown menu set to 'All' with a 'Download Configuration' button. The 'Restore Configuration' section has a red warning box stating 'JSON Backups made from FPP v1.x are not compatible with FPP 3.x and higher.' Below this, there are two checkboxes: 'Keep Existing Network Settings' and 'Keep Existing Master/Remote Settings', both checked with green checkmarks. At the bottom, there is a 'Restore Area' dropdown menu set to 'All' and a 'Choose File' button with the text 'No file chosen'.

### Backup Configuration (creating a backup)

**Protect sensitive data-** If you have this selected, then the password to your wlan0 network will not be saved and you will have to log into the device once the configurations have

been restored and enter your wlan0 password. If it is not selected, then a complete backup will be saved and when restored the FPP should be functional. Just be aware that anyone that has access to the backup file you saved will be able to view your wireless password if they open up the backup file. If you change the setting to allow a complete backup, you will get the following information box.

×

Un-checking this box will disable protection (automatic removal) of sensitive data like passwords.

**ONLY** Un-check this if you want to be able make an exact clone of settings to another FPP.

**NOTE:** The backup will include passwords in plaintext, you assume full responsibility for this file.

Backup area-This will select what portion of your FPP configuration you want to save, normally you will select all. You can select individual sections if you want.

**Backup Configuration**

Protect sensitive data?

Backup Area

**Restore Configuration**

JSON Backups made from FPP v1.x are not compatible

- All
- All
- Channel Inputs (E1.31 Bridge)
- Channel Outputs (Universe, Falcon, LED Panels, etc.)
- Pixel Overlay Models Old(Channel Memory Maps)
- Pixel Overlay Models
- Output Processors
- Show Setup (Events, Playlists, Schedule, Scripts)
- System Settings (incl. GPIO Input, Email, Timezone)
- Plugin Settings
- Network Settings (Wired & WiFi)

Download Configuration- click on this button to save your configuration settings. This will prompt you for a location to save your configuration file onto your computer. The file will be named with the device name and a timestamp in the name so that you can identify the most current version in case you have more than one backup.

**NOTE:** This will not save your media files such as sequences, music, or videos.

## Restore Configuration

Keep Existing Network Settings-If this is selected, then the network settings that are saved on the FPP will not be updated to the settings on the saved backup.

Keep Existing Master/Remote Settings- If this is selected, then the Master/Remote settings that are saved on the FPP will not be updated to the settings on the saved backup.

Restore Area-You can select only a specific area to restore on the FPP. Any other settings that are configured on the FPP will not be updated.

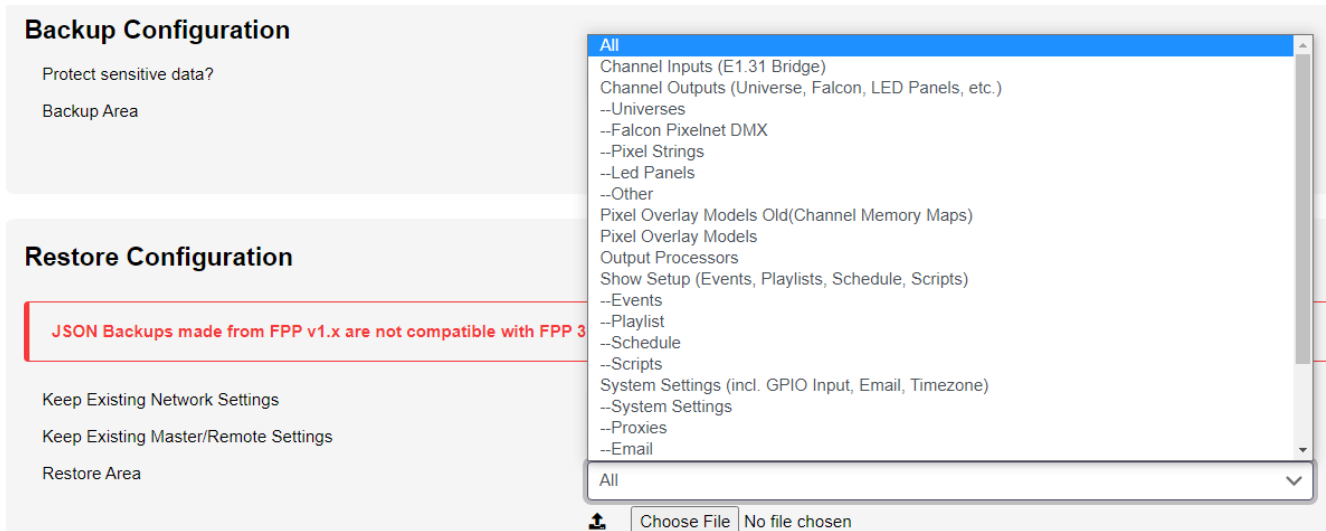

Choose File-Click on this button and find the backup file that you want to use for your restored settings. Make sure it is the correct one if you have multiple configurations saved.

Restore Configuration-If you have a backup file selected, then you can click this button to restore the FPP from your backup file with the settings selected.

## File Copy Backup

The File Copy Backup utility gives you the ability to copy every item stored on your FPP device with the exception of the operating system. This can be very useful in maintaining copies of your FPP devices in case of an unforeseen event. You can save your backups to several different locations depending on your needs.

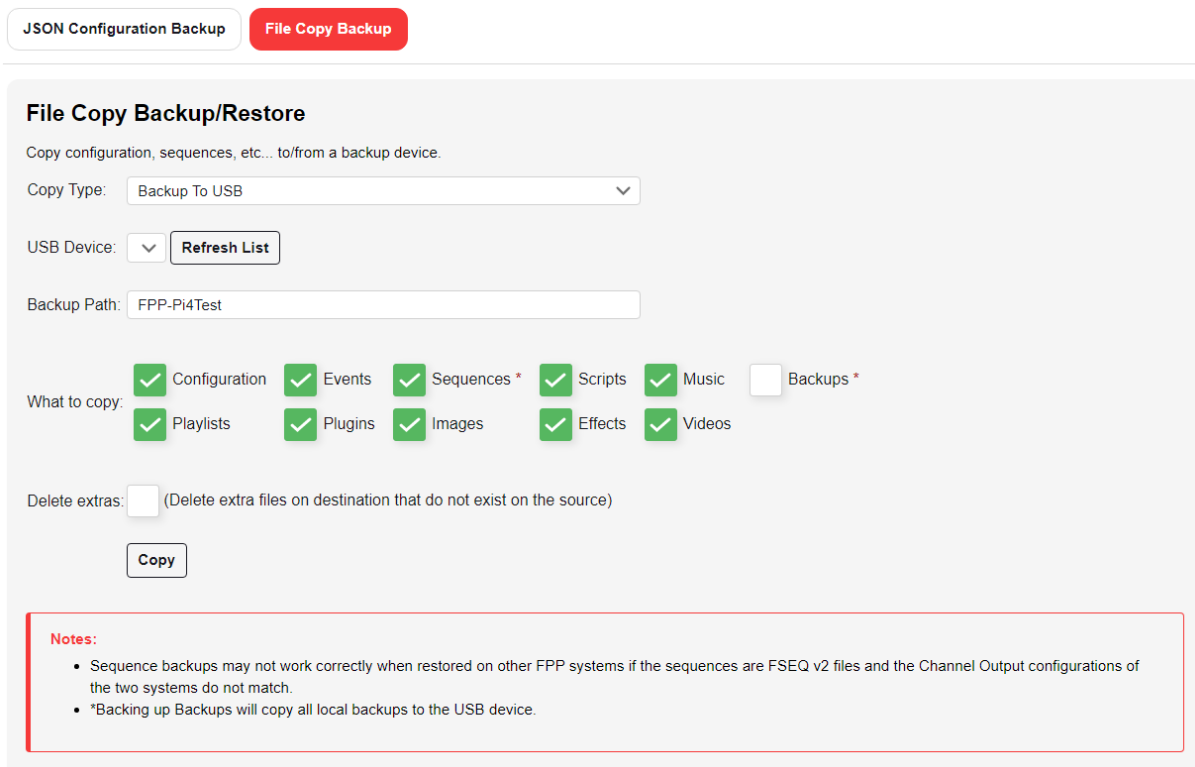



Note: if you plugged in the USB drive after the FPP device booted up, you might have to press the Refresh List button to get the current USB status.

Copy Type- Select the type of copy function that you want to perform.

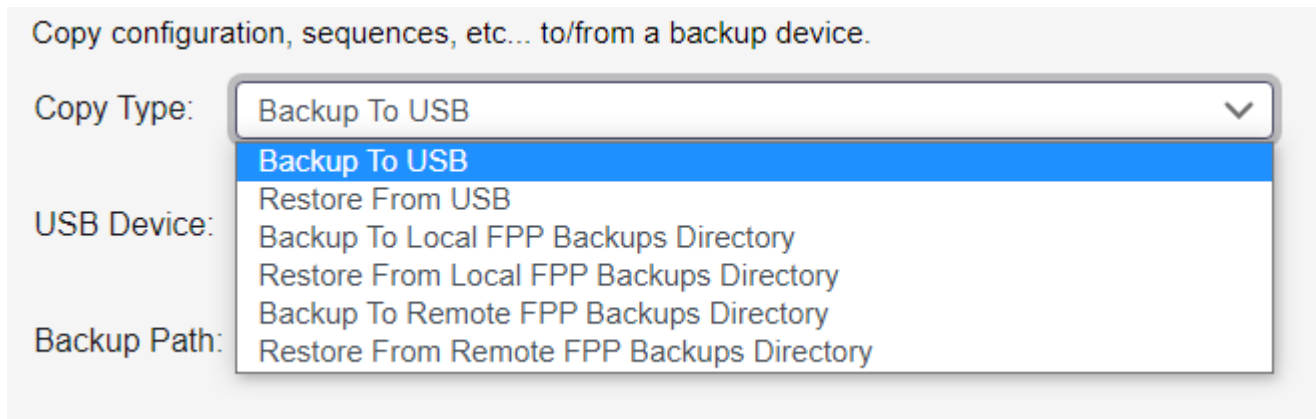

- Backup To USB- This will allow you to copy the selected items from this FPP device to the USB drive on the FPP device that you select.
- Restore From USB- This will allow you to copy the selected items from the selected USB drive to the original locations on this FPP device.

**NOTE: This will overwrite any files currently on your FPP Device.**

- Backup to Local FPP Backups Directory- This will allow you to copy the selected items from this FPP device to a backup folder on the uSD card that is on this FPP device.
- Restore From Local FPP Backups Directory- This will allow you to copy the selected items from a backup folder on this FPP device to the original locations on this FPP device.

**NOTE: This will overwrite any files currently on your FPP Device.**

- Backup To Remote FPP Backups Directory- This will allow you to copy the selected items from this FPP device to a backup folder on a different FPP device within your show network. When you select this option, you will get an additional field to enter the Hostname or IP address of the FPP device that you want to send the Backup files.
- Restore From Remote FPP Backups Directory- This will allow you to copy the selected items from a backup folder on a remote FPP device to the original locations on this FPP device.

**NOTE: This will overwrite any files currently on your FPP Device.**

USB Device- When you choose any of the USB options, this will become available. You will select the USB drive that you want to load files to or from. If your USB drive is not visible, click on the Refresh List button.

Hostname/IP- When you choose any of the Copy to Remote or Copy From Remote options, this will become available. You will enter either the Hostname or IP address of the remote FPP device that you want to load files to or from.

Backup Path- If you select any of the Copy To options, this will populate with the Hostname of the FPP device, you can change this if you want but make sure you know which FPP the backup belongs to. If you select any of the Copy From options, this will populate with the available backup directories. If you selected the Copy From USB option and the USB does not display the correct Backup path, then click the Refresh List button.



What to copy- You can select the items that you want to copy to the backup folder selected.

Delete extras- If you select this option, the restore function will delete any existing files that are on the FPP device before restoring from the selected backup folder.

**There is no advanced warning if there is not enough space to save your backup files, but during the backup process there will be an error message similar to this if there wasn't enough space:**

```
rsync: write failed on
"/var/tmp/ctp/nutcracker/.git/objects/pack/pack-736c8d4bcafdd7ab17fd41db17e9159af688db24.p
ack": No space left on device (28)
rsync error: error in file IO (code 11) at receiver.c(393) [receiver=3.1.2]
```

**If you didn't get a complete backup, the restoration process will not be complete.**

## Proxy Settings

The Proxy Settings allows you to route network traffic through an FPP device to a connected controller.

**Proxied Hosts** Status/Control Content Setup Input/Output Setup Help

**Proxied Hosts** Delete + Add Save

#	IP/HOSTNAME	LINK
1	<input type="text" value="192.168.2.250"/>	<a href="#">192.168.2.250</a>

**Notes:**  
This is a list of ip/hostnames for which we can reach their HTTP configuration pages via proxy through this FPP instance.  
For example, if this FPP instance is used as a wireless proxy to another e1.31 controller where FPP communicates to the "show network" via the WIFI adapter and to the controller via the ethernet adapter, you can put the IP address of the e1.31 controller here and access the configuration pages by proxy without having to setup complex routing tables.

You can configure the FPP to act as a Proxy Host by entering the IP address of the controller(s) that are attached to the FPP device. By doing so, you do not need to enter static route(s) in either your computer or router. This is helpful for people using Mac computers where the route is not persistent. If you need to access the controller through the web UI then you can click on the link in the Proxied Hosts page or type the IP address of your FPP device that is connected to the controller followed by /proxy/ and then the address of your controller so if your FPP device's wlan0 IP address is 192.168.1.101 and your controller's IP address is 192.168.101.2 then to go directly to your controller, you would enter 192.168.1.101/proxy/192.168.101.2 in the address bar of your web browser. (Not all controllers support the Proxy Host functionality. Falcon controllers (with current firmware) and KulpLights.com controllers support the Proxy Host functionality.)

Note: If you use xLights for configuration settings, then you can enter the controller's proxy settings in xLights and xLights will be able to communicate with your controller.

# Command Presets

Command Presets is the replacement for the previous Events as it has been greatly enhanced and modified. Command Presets are a method to activate FPP Commands. **With the addition of FPP Commands in playlists and GPIO commands, you no longer need to create Command Presets (aka Events) first, however, if you are going to use the same FPP command in more than one place/location, you can create a Command Preset to make it a little easier.** Examples of how to configure these are at the end of this section. Command Presets can be triggered in 4 different ways.

- Playlist- You can trigger a Command Preset as part of a Playlist like a Lead In item. This could be useful for things like starting a Plugin, radio or other device through a relay at the beginning of your show and turning them off at the end of the show.
- Sequence- You can trigger a Command Preset in the middle of a sequence. This could be useful for things like triggering a Countdown display on a Matrix panel at certain points in a sequence.
- GPIO Input- You can trigger a Command Preset through one of the GPIO input pins on your FPP device. This could be useful for things like having a push button play a certain sequence or start your show.
- Manual Trigger- you can trigger a Command Preset from the Command Preset page. This can be useful for testing your Events.

**Preset Name-** Use a name that makes sense what this Preset is doing. You might have several events that are similar so make the name clear as to what it does like StartMainPlaylist and StartOvernightPlaylist.

**FPP Command-** There are many FPP Commands to choose from and will support anything you might need to do:

- All Lights Off- This will turn all of the lights off.
- Effect Start- This will start an effect that has been previously saved on the FPP device.
- Effect Stop- This will stop a selected effect that is running on the FPP device.
- Effects Stop- This will stop all effects that are running on the FPP device.

- Extend Schedule- You can extend (or shorten) the playlist that is currently playing if it was started through your scheduler. You will enter the number of minutes that you want to change your schedule end time. Negative numbers will shorten the playlist.
- FSEQ Effect Start- You can start any of your stored .FSEQ files. You can select it to loop so it will play until you manually stop it. You also have the option to run it in the Background (running in the background will play an effect until a playlist is played and when the playlist ends, the background effect will resume)
- FSEQ Effect Stop- You can stop any of your stored .FSEQ files that are currently playing through an Event.
- GPIO- You can set the state of the GPIO pins to on or off.
- Insert Playlist After Current-You can insert a saved playlist to start after the currently playing playlist completes. You can select a start item in the playlist to start at and a playlist item to stop at. The scheduled playlist will resume once the inserted playlist has completed.
- Insert Playlist Immediate- This will start a playlist immediately and will stop whatever playlist is playing. You can select a start item in the playlist to start at and a playlist item to stop at. The scheduled playlist will resume once the inserted playlist has completed.
- Next Playlist Item- This will start the next playlist item in a currently playing playlist. If you are on the last item in your playlist, it will start the first item in your playlist.
- Overlay Model Clear- You can clear the data displayed on a Pixel Overlay Model.
- Overlay Model Effect- This will apply different effects to a pixel Overlay model. The effects that you can choose are:
  - Color Fade- You can fade in/out a solid color that you select. You can select the duration of the Fade in and Fade out.
  - Bars- you can display scrolling bars on your Pixel Overlay Model. You can select the colors, direction, number of bars, duration etc. to display.
  - Text- You can display text on your Pixel overlay model. You can select the font, color, font size and scroll options.
- Overlay Model Fill- This will apply a solid color effect to a Pixel Overlay model.
- Overlay Model State- This will apply a state to a Pixel Overlay model such as enabled, disables, Transparent and Transparent RGB.
- Pause Playlist- This will pause the currently playing playlist.
- Play Media- This will play media files on your Pixel Overlay model.
- Prev Playlist Item- This will start the previous playlist item in a currently playing playlist. If you are on the first item in your playlist, it will start the last item in your playlist.
- Remote Effect Start- This will start an effect that is stored on one of your remote devices. You will have to enter the effect name exactly as it is stored on the remote.
- Remote Effect Stop- This will stop an effect that is currently playing on one of your remote devices. You will have to enter the effect name exactly as it is stored on the remote.
- Remote FSEQ Effect Start- You can start any of your stored .FSEQ files on a remote FPP device. You can select it to loop so it will play until you manually stop it. You also have the option to run it in the Background (running in the background will play an effect until a playlist is played and when the playlist ends, the background effect will resume)
- Remote Playlist Start- This will start a playlist on a Remote FPP device (NOT a Remote FPP device that is set to Remote Mode.)
- Remote Run Script- This will start a script that is stored on one of your remote devices. You will have to enter the script name exactly as it is stored on the remote.

- Remote Trigger Command Preset- This will start a Command Preset that is stored on one of your remote devices. You will have to enter the Preset Name for the event you want to trigger.
- Remote Trigger Command Preset Slot- This will start a Command Preset that is stored on one of your remote devices. You will have to enter the Preset Slot for the event you want to trigger.
- Restart Playlist Item- This will restart a currently playing playlist item.
- Resume Playlist- This will resume a previously paused playlist.
- Run Script- This will start a script that is stored on this FPP device. You will select the script and enter any Arguments or Variables if needed
- Start Playlist- This will start a playlist that is stored on this FPP Device. You will need to select the Playlist and if you want it to repeat.
- Start Playlist at Item- This will start a playlist at a specific item in that Playlist. You will need to select the Playlist and if you want it to repeat.
- Start Playlist at Random Item- This will start a playlist at a random item in that Playlist. You will need to select the Playlist and if you want it to repeat.
- Stop Gracefully-This will stop the currently playing playlist Gracefully (complete the currently playing item and then stop)
- Stop Now--This will stop the currently playing playlist immediately.
- Toggle Playlist- This will toggle the playlist to a different playlist and you can select the Stop type.
- Trigger Command Preset- This will start a Command Preset that is stored on this FPP device. You will have to enter the Preset Name for the command you want to trigger.
- Trigger Command Preset Slot- This will start a Command Preset that is stored on this FPP device. You will have to enter the Preset Slot for the command you want to trigger.
- Trigger Multiple Command Preset Slots- This will start up to 4 Command Presets that are stored on this FPP device. You will have to enter the Preset Slots for the command you want to trigger.
- URL- You can use URL GET or POST actions to control/communicate with your PFF Device. Enter the URL, Method and any data required.
- Volume Adjust- You can adjust the volume either up or down in steps.
- Volume Decrease- You can adjust the volume down in steps.
- Volume Increase- You can adjust the volume up in steps.
- Volume Set. - You can set the volume to a set level from 0 to 100%

FPP Event Commands- FPP has some built in commands that are triggered by system events. These commands are available in the dropdown list before you enter any text.

- FPPD\_STARTED- This will trigger any time FPPD is started.
- FPPD\_STOPPED- This will trigger any time FPPD is stopped.
- PLAYLIST\_STARTED-
- PLAYLIST\_STOPPED- This will trigger each time a playlist is stopped.
- PLAYLIST\_START\_TMINUS\_xxx- This will trigger xxx seconds before a playlist is started.
- SEQUENCE\_STARTED- This will trigger each time a sequence is started.
- SEQUENCE\_STOPPED- This will trigger each time a sequence is stopped.
- MEDIA\_STARTED- This will trigger each time a media file is started.
- MEDIA\_STOPPED- This will trigger each time a media file is stopped..

Preset Slot- The Preset Slot is used to identify which Command Preset you want to trigger from within a sequence and will have a value of 1-255. If you are not going to trigger a

Command Preset from within a sequence, then this is not needed. In order to trigger a Command Preset from within a sequence, you need to set up a “dummy” pixel in your layout to capture your trigger signals and configure the associated channel number in your [Input/Output](#) settings.

Preset List-This will list all of the Command Presets that you have created along with the relevant details. From this section you can add an event, trigger an event, clone or edit an existing event or delete an existing event.

FPP Command Editor- This section is for editing saved Command Presets.

### FPP Command Editor

---

Command:

Multicast:

Seconds:

---

Don't forget to save your Command Preset(s) once you are done.

The following steps will demonstrate how to create a Command Preset to get triggered from the three methods that can trigger a Command Preset.

## Creating an Command Preset to be Triggered in a Playlist

This example is to demonstrate how you can display a countdown to Christmas (or any date that you want) by using a Playlist entry and the Event Date Plugin. This will assume that you have already installed and set up the [Event Date Plugin](#) (and associated Plugins and script). But you can trigger any other Command Preset that is properly configured in a similar manner.

- Go to the Command Preset page and click on +Add, this will add a new line entry to the bottom of the Preset list.
- Enter a Preset Name that would explain what the Command Preset is doing (RunCountdown for this example.)
- Select the Run Script option for the Command (If the developer of the Plugin created FPP Commands, then you could just select the appropriate FPP Command)You will get the FPP Command Editor window
- Select the Script or FPP Command that you want (RUN-COUNTDOWN-SCRIPT.sh for this example) and click on Accept Changes.

Command:

Multicast:

Script Name:

Script Arguments:

Environment Variables:

- Enter a number in the Preset Slot. This should be a number from 1-255 and this number is used to identify this particular Preset. For this example we are going to use 3.

PRESET NAME	FPP COMMAND	PRESET SLOT #
<input type="text" value="Extend 20"/>	Extend Schedule ARGS: 300	<input type="text" value="2"/>
<input type="text" value="Run Countdown"/>	Run Script ARGS: RUN_COUNTDOWN-SCRIPT.sh	<input type="text" value="3"/>
<input type="text" value="Remote Falcon On"/>	Run Script ARGS: viewer_control_on.php	<input type="text"/>

- Go to the Playlist section in FPP.
- Select the Playlist that you want the Command Presetto be triggered from.
- In the Add a Sequence/Entry select:
  - Type- FPP Command
  - Command- Trigger Command Preset Slot, the window will change to allow the relevant options. (you can select Trigger Command Preset but you have to enter the Command Preset name exactly as you have saved it)
  - Preset Slot- Enter the number of the Command Preset that you want to trigger, in this example we are using 3 and click on Add.

New Entry

Type:

Command:

Note:

Multicast:

Preset Slot:

- You can drag the Event to the location in the playlist that you want it to be activated by clicking and dragging the entry to the right location.

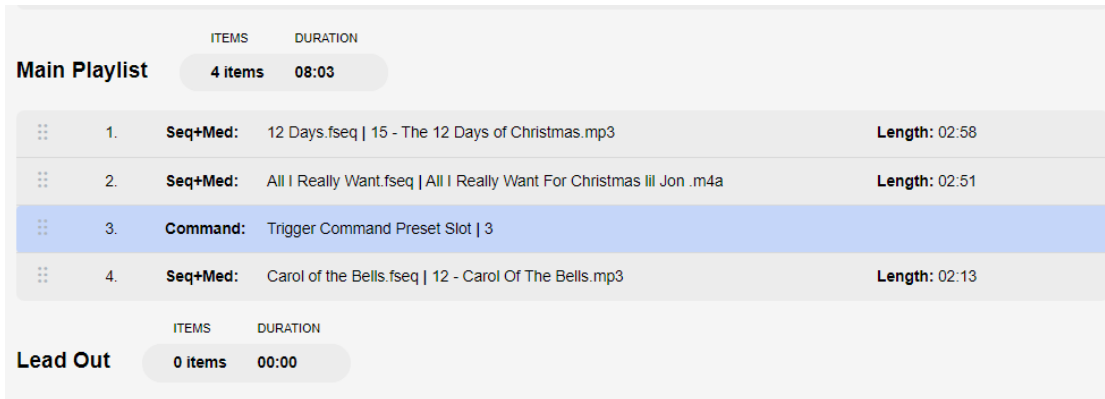

## Creating a Command Preset to be Triggered in a Sequence.

This example is to demonstrate how you can activate a Projector from within a sequence. This will assume that you have already set up the [Projector Control Plugin](#) (and associated scripts). But you can trigger any other Command Preset that is properly configured in a similar manner.

Open xLights and determine what unused channel you are going to use for triggering your event. This will vary greatly depending on how you have your layout configured. Usually you can add a DDP or E1.31 Universe to the end of the Controller that you are configuring the event for or use an unused channel in an existing DDP or E1.31 Universe.

Here is a screenshot of the Setup screen of a display in xLights.

Number	Network...	Port	Universe or Id	Num...	xLights/Vixen/FPP Mappi...	A...	Description
1	E131	192.168.101.2	100-114	512	Channels 1 to 7680	Yes	F16V3-Yard
2	E131	192.168.1.106	120-127	512	Channels 7681 to 11776	Yes	F8B Right Yard
3	E131	192.168.1.102	200-210	512	Channels 11777 to 17408	Yes	F8PB-LeftRoof
4	E131	192.168.1.103	300-301	512	Channels 17409 to 18432	Yes	F8PB-RightRoof
5	E131	192.168.1.104	400-427	512	Channels 18433 to 32768	Yes	PocketScroller
6	E131	192.168.1.105	500-505	512	Channels 32769 to 35840	Yes	F8PB Singing Elements

And we want to put the Event on the F16V3-Yard Controller. You can see that channels 1-7680 have been designated for this controller.

Here is a screenshot of the layout screen of the same display.

> Whole House			
Mega Tree	#100:1 (1)	#114:32 (7200)	WS2811:1-8
> Boscoyo Star 23 3 ring	> Mega Tree:1 (7201)	#114:302 (7470)	WS2811:9
Arches 04	#120:1 (7681)	#120:150 (7830)	WS2811:10
Arches 03	> Arches 04:1 (7831)	#120:300 (7980)	WS2811:10
Arches 02	> Arches 03:1 (7981)	#120:450 (8130)	WS2811:10
Arches 01	> Arches 02:1 (8131)	#121:88 (8280)	WS2811:10



From these screenshots you can see that the last Universe (114) on the F16V3-Yard ends on Channel 7680, but the last model on that controller, Boscoyo Star 23 3 Ring, ends on 7470 so we have 210 unused channels that are designated for the controller that are not getting used and we can use any of those to trigger the event. For simplicity sake, we will use Channel 7471 for the Command Preset Control Channel, but keep in mind that if you change models on this controller, you might have to redo your Command Preset Settings, Command Preset Control Channel and Layout in xLights.

Open xLights and go to the Layout tab (or the method for your sequencing software) and add a Channel Block model. Set the following properties:

Name- Trigger Channel (or whatever name makes sense to you)

# Channels- 1

Controller-Set this to Use Start Channel

Start Channel- 7471 (to set this, you might have to click on the box with the three dots at the right of the Start Channel box and enter the Start Channel, 7471 in this case, and then select the None (Absolute) option).

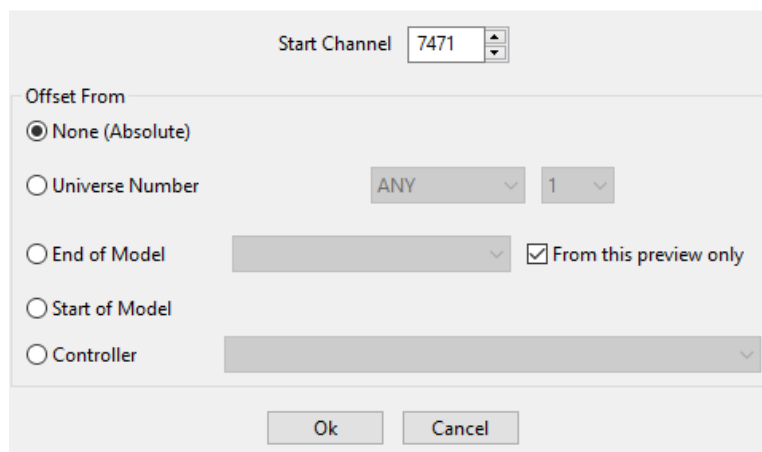

It should look something like this:

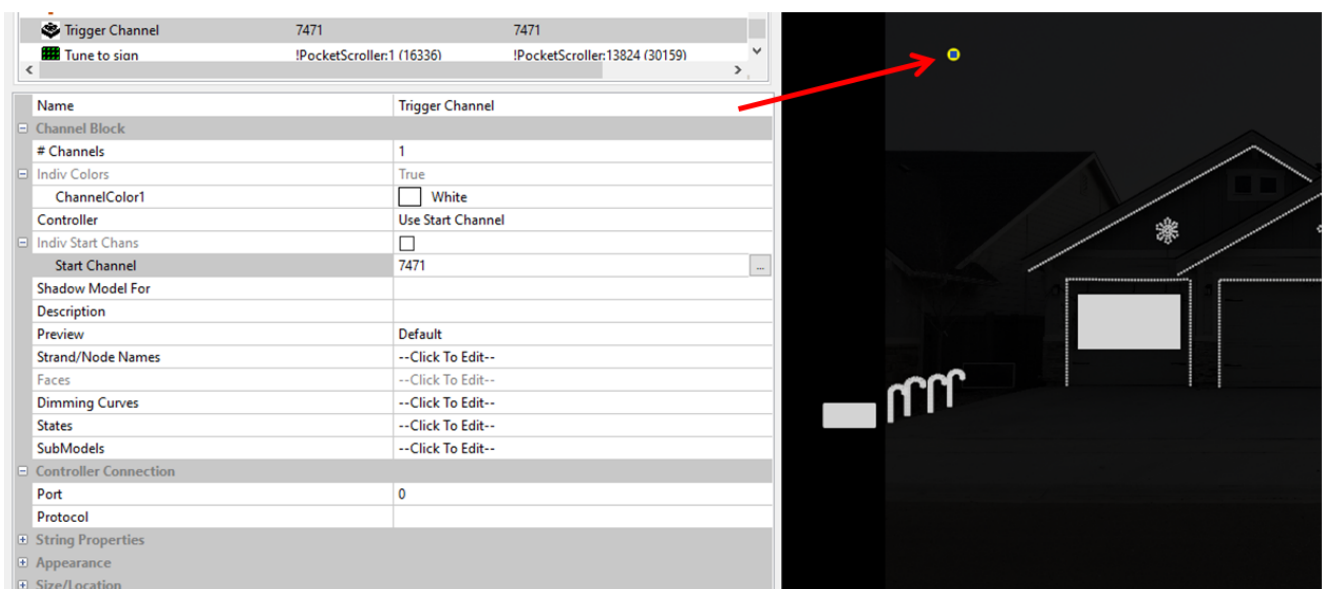

Don't forget to save your Layout.



Go to your FPP Settings Page and the Input/Output tab and you will set the Command Preset Channel to 7471 The Projector Control Plugin will create the FPP Commands/Scripts you need if properly configured.

## Input Control

Disable Network Bridge Monitoring (E1.31/DDP/ArtNet)  ?

**Command Preset Control Channel**  ?

Then you will need to configure the Command Preset.

- Go to the Command Preset page and click on +Add, this will add a new line entry to the bottom of the Preset list.
- Enter a Preset Name that would explain what the Command Preset is doing (Projector On for this example.)
- Select the Run Script option for the Command (If the developer of the Plugin created FPP Commands, then you could just select the appropriate FPP Command). You will get the FPP Command Editor window
- Select the Script (or FPP Command) that you want to run (PROJECTOR\_ON FPP Command for this example) and click on Accept Changes.

### FPP Command Editor

Command:  ▾

Multicast:

- Enter a number in the Preset Slot. This should be a number from 1-255 and this number is used to identify this particular Preset. For this example we are going to use 4.

Extend 20	Extend Schedule ARGS: 300	Edit	Run Now	MCast: N	2
Projector On	PROJECTOR_ON	Edit	Run Now	MCast: N	4
Run Countdown	Run Script ARGS: P1 IN : COUNTDOWN_SCRIPT.sh	Edit	Run Now	MCast: N	3

Then go to the Sequencer tab and open the sequence that you want to create your trigger. Add a DMX Effect to your Trigger Channel (or whatever you called it) at the location in the timeline where you want to activate the Command Preset. We want to turn the Projector on at the beginning of the sequence, so we will set the value of Channel 1 to 4 (Channel 1 in the DMX effect will correspond to your Command Preset Channel and the value that you set in that channel will be which Command Preset slot you want to activate) )

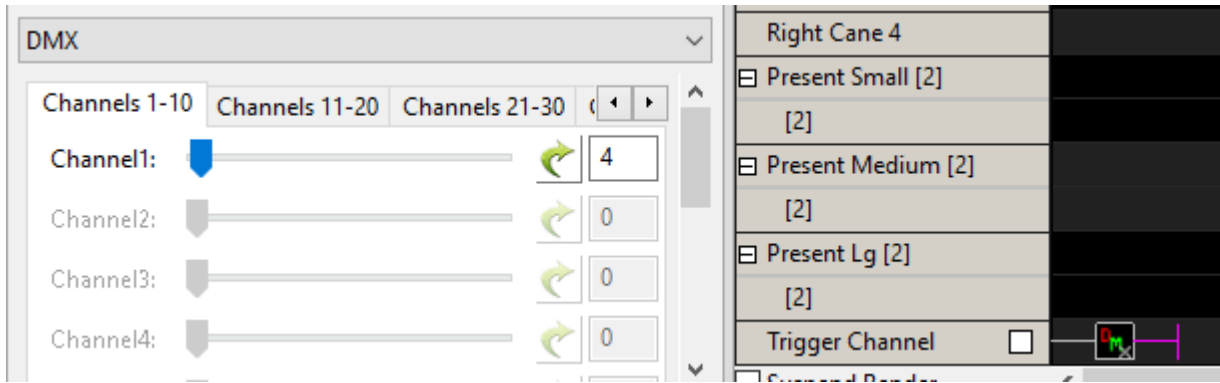

If you wanted to turn off the projector, you would need to follow the same steps but with a Command Preset configured to turn off the projector.

## Creating a Command Preset to be Triggered by a GPIO Button.

This example is to demonstrate how you can start a playlist from a push button connected to one of the GPIO pins like when someone drops a letter to Santa in a Mailbox. This will assume that you have already wired up the button to the GPIO pin and created the playlist that you want to play when the GPIO trigger is activated (for this example, the playlist is called “Thank You”). If you are not sure how to wire the GPIO button, refer to the [GPIO Button Input](#) section. You can trigger any other Command Preset that is properly configured.

- Go to the Command Preset page and click on +Add, this will add a new line entry to the bottom of the Preset list.
- Enter a Preset Name that would explain what the Command Preset is doing (Start Thank You Playlist for this example.)
- Select the Start Playlist option for the Command.
- You will get the FPP Command Editor window
- Select the playlist that you want to run (Thank You for this example) and click on Accept Changes.

### FPP Command Editor

---

Command:

Multicast:

Playlist Name:

Repeat:

If Not Running:

---

---

- Enter a number in the Preset Slot. This should be a number from 1-255 and this number is used to identify this particular Preset. For this example we are going to use 5.

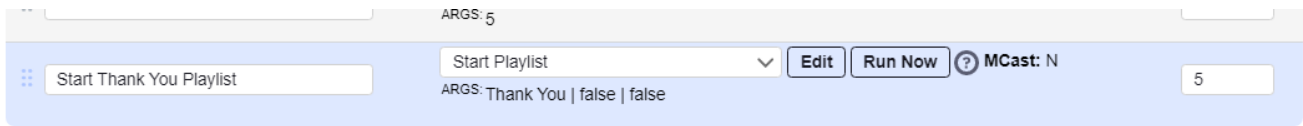

- Go to the GPIO Inputs in the Input/Output tab of FPP
- Click on the En. (Enabled) box next to the pin that you are using (you might have to refer to a Pinout chart to see which pins are GPIO pins and the correct numbering). For this example, we are using HDR-PIN P8-04
- Set the Pull Up/Down if you want to use the internal Pull up or Pull Down resistors. Select None/External if you are going to wire your button circuit with a Pull up or Pull Down resistor. For this example we are using the internal Pull Down setting.
- Select the Command to Trigger Command Preset slot that you want for either the Rising or Falling trigger that you are using (this will depend on how you wire your button.) For this example, we are using the Rising EdgeTrigger and selecting Preset Slot 5
- Click on the Save button
- Click on the Restart FPPD button at the top of the page.

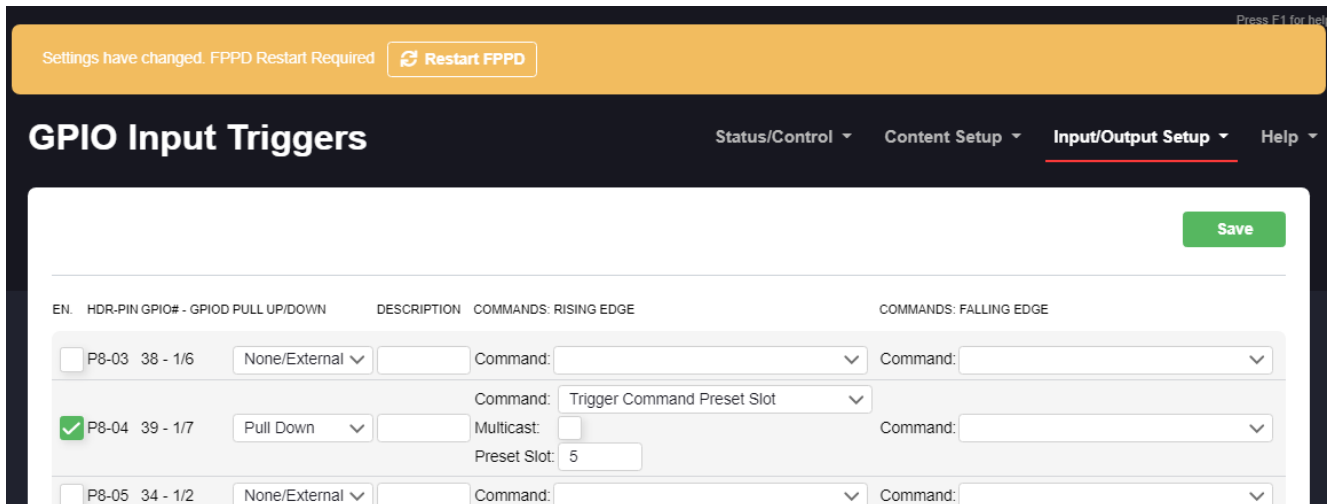

## Effects

Effects or effect sequences are normally used where you want to have some components of your show run and/or turn off or in parallel with and independent of the main show sequences. Typically Effect Sequences (.eseq files) are created for just one model in your sequencing software.

**Effects** Status/Control ▾ Content Setup ▾ Input/Output Setup ▾ Help ▾

---

**Effects Library**

EFFECTS LIBRARY	TYPE	
12 Days	fseq	<span style="background-color: green; color: white; padding: 2px 5px;">Start</span>
All I Really Want	fseq	<span style="background-color: green; color: white; padding: 2px 5px;">Start</span>
All I want for Christmas is You	fseq	<span style="background-color: green; color: white; padding: 2px 5px;">Start</span>
Carol of the Bells	fseq	<span style="background-color: green; color: white; padding: 2px 5px;">Start</span>
Donde esta Santa Clause	fseq	<span style="background-color: green; color: white; padding: 2px 5px;">Start</span>
Hippo	fseq	<span style="background-color: green; color: white; padding: 2px 5px;">Start</span>
Present Small	eseq	<span style="background-color: green; color: white; padding: 2px 5px;">Start</span>
Tree 01	eseq	<span style="background-color: green; color: white; padding: 2px 5px;">Start</span>

**Running Effects**

There are currently no effects running

The Effects page is used to manually start or stop effects. You can move effects to a model that has the same attributes. In order to do so, you will need to enter a channel offset. This offset will be the absolute channel for the start of the model you want to move the effect to.. For example, you have two mini tree models and you created an effect on one of the trees and this tree has a start channel of 1326. To apply the same effect to another mini tree of the same size that has a start channel of 1842 you would select the effect from the Effects Library and enter 1842 in the Start Channel Override and then click on the Play Effect.

**Start Effect Rockin Around The Christmas Tree** ✕

---

Loop Effect:       Run in Background:

Start Channel Override:

---

Start Effect

## Display Testing

The Display Testing screen can be used to test the channel outputs as well as to quickly test sequences without having to define playlists etc. This is a useful tool for troubleshooting!

# Channel Testing

Enable Test mode-When this is selected, (a checkmark in the box) then the test mode is active. **Make sure you deselect this when you are done testing or you will get unexpected results.**

Model Name- If you have uploaded or configured Pixel Overlay models, then you can select individual models to test. When you select a model the Channel Range to Test will update to the defined channels for that model.(FPP will Auto Generate some models for you.)

Channel Range to Test-This section is used to select a range of channels that you want to test. You do not need to change anything here unless you want to select specific channel ranges. By default, FPP will load the channel ranges that this FPP has configured in its settings. Channel Up/Down buttons- You can add or subtract one pixel (3 channels) to the end of the Channel Range with these buttons.

Update Interval-You can change how quickly the pattern changes with this slider.

## RGB Test Patterns

**\*Note: The RGB Patterns do not take into account output setups so depending on your configuration the colors might not display in a true Red/Green/Blue pattern.**

The RGB Test Pattern will test the lights based on specified colors. The color order can be changed to match the color order of the lights you are testing.

## Chase Patterns

The Chase patterns will light up the string with alternating colors as specified and then the colors will shift along the string.

- Chase R-G-B This pattern will set every 3 lights in a red, green, blue pattern and then shift this pattern up the string of lights.
- Chase R-G-B-All > This pattern will set every 4 lights in a red, green, blue, white pattern and then shift this pattern up the string of lights.
- Chase R-G-B-None> This pattern will set every 4 lights in a red, green, blue, off pattern and then shift this pattern up the string of lights.
- Chase R-G-B-All-None> This pattern will set every 5 lights in a red, green, blue, white, off pattern and then shift this pattern up the string of lights.
- Chase Custom Pattern-You can create a custom pattern for your chase. The numbers for the colors are the standard hexadecimal RGB color notation where there are 6 total digits and the first 2 are the intensity of red (00-FF), the second 2 are the intensity of green (00-FF), and the third set is the intensity of blue (00-FF). You can enter up to 9 colors.

## Cycle Patterns

Cycle patterns will light the entire string one color and then cycle the entire string to the next color.

- Cycle R-G-B > This pattern will cycle all the lights in a red, green, blue pattern.
- Cycle R-G-B-All > This pattern will cycle the lights in a red, green, blue, white pattern.
- Cycle R-G-B-None> This pattern will cycle the lights in a red, green, blue, off pattern.
- Cycle R-G-B-All-None> This pattern will cycle the lights in a red, green, blue, white, off pattern.
- Cycle Custom Pattern-You can create a custom pattern for your cycle. The numbers for the colors are the standard hexadecimal RGB color notation where there are 6 total digits and the first 2 are the intensity of red (00-FF), the second 2 are the intensity of green (00-FF), and the third set is the intensity of blue (00-FF). You can enter up to 9 colors.

## Solid Color Test Pattern

Solid color will fill the entire string with the color selected.

- Fill Color- If you select this option, then all of the lights will be illuminated with the color selected in the sliders. There is a graphical representation of the color in the box next to the Fill option.

### Solid Color Test Pattern

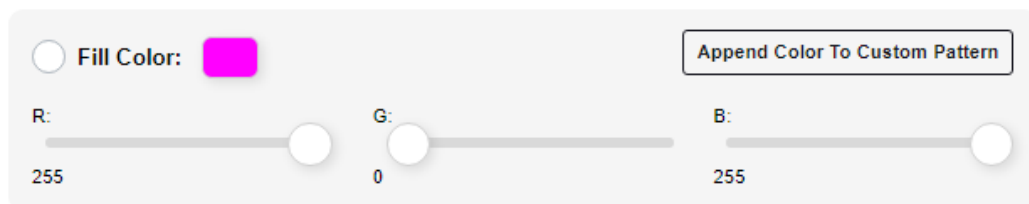

The screenshot shows a control panel for the 'Solid Color Test Pattern'. It features a radio button labeled 'Fill Color:' next to a small magenta color indicator box. To the right is a button labeled 'Append Color To Custom Pattern'. Below these are three horizontal sliders for color intensity: 'R:' (Red) with a value of 255, 'G:' (Green) with a value of 0, and 'B:' (Blue) with a value of 255. Each slider has a white knob and numerical labels at the ends.

You can also click on the color indicator box to choose from a color picker tool.

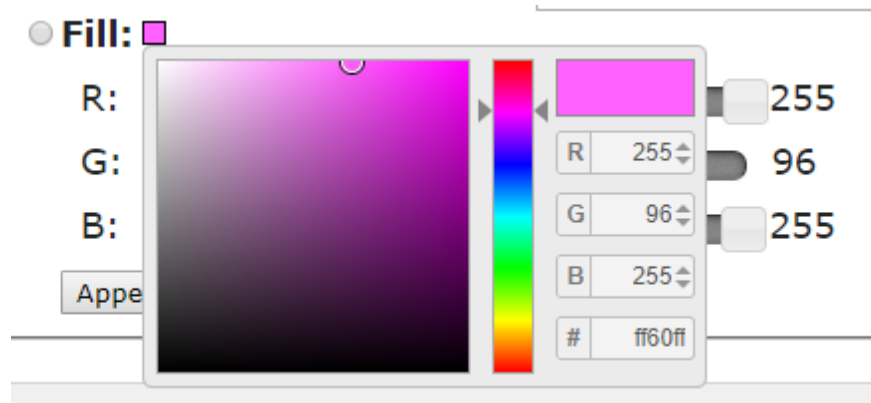

Append Color to Custom Pattern- This will add the color selected by the color sliders to the Chase: Custom Pattern text box.

## Single Channel Patterns

This setting will test your prop based on channel value. Test Value is the value sent. The fill option will send the Test value to all the channels. There are several Chase Sizes options.\*

When you select a Chase Size, it will send out a packet the size of the selected chase size with the first channel being the Test Value selected and the remainder of the packet channels set to 0, and then the packet will repeat.

## Sequence

The Sequence testing tab will allow you to test a stored sequence.

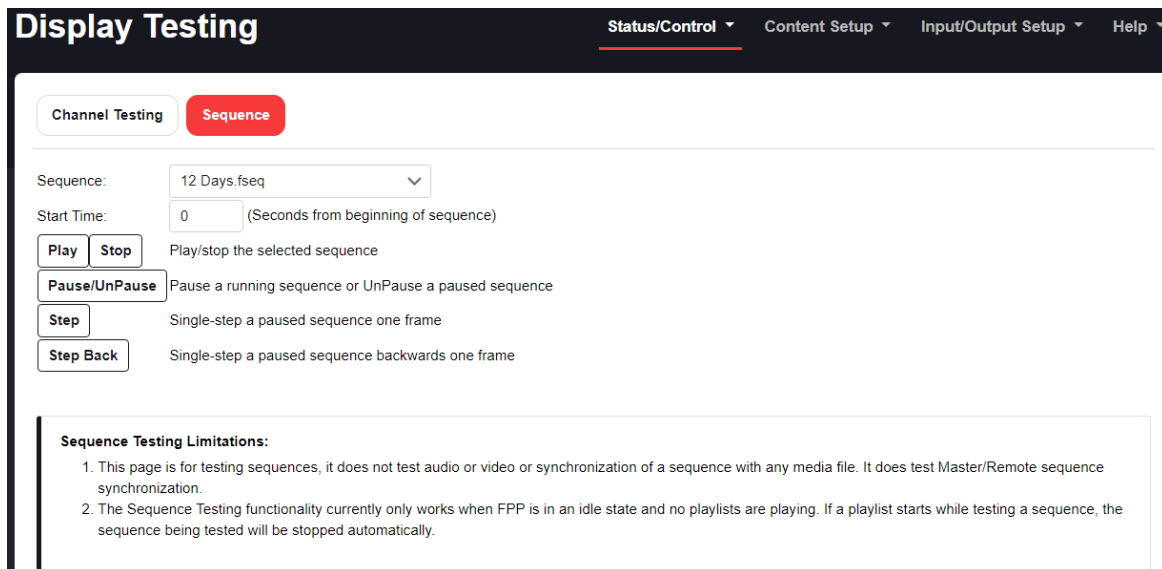

**Note:** Only the sequence data is output on the local system. Audio or video is not played. Network and channel configuration definitions must have been defined prior to Display Testing.

# Content Setup

This section is to manage the contents that you can customize for this FPP

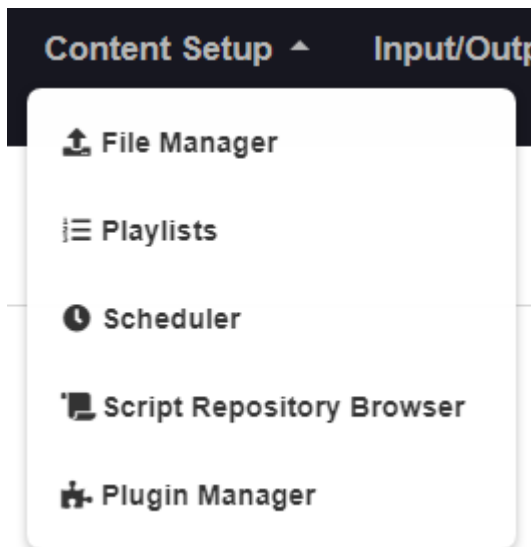

## File Manager

The file manager is where you can manage your personalized files on your FPP. From this screen, you can upload, download, and in some cases, modify the files that are on FPP. Some of the personalized files are: sequence files, effect sequences, music files, video files, scripts, system logs and miscellaneous files.



### Sequence Files (.fseq)

12 Days.fseq	215B	07/20/21 07:32 PM
All I Really Want.fseq	1.80KB	07/20/21 07:32 PM
All I want for Christmas is You.fseq	213B	07/20/21 07:32 PM
Carol of the Bells.fseq	241B	07/20/21 07:32 PM
Donde esta Santa Clause.fseq	681B	07/20/21 07:32 PM
Hippo.fseq	258B	07/20/21 07:32 PM

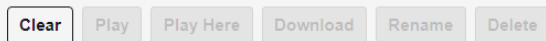

CTRL+Click to select multiple items

Drag & Drop or Select Files to upload

Select Files



You can upload files to your FPP by dragging them from your computer's file manager onto the Upload Files section of the FPP File Manager. You have to drag it into the small box that has the dotted lines surrounding it.

FPP will display the files in the tab that is appropriate for the file type. If you have uploaded a file that doesn't match one of the standard file types, they will be displayed in the upload tab. Some tabs will have some additional options besides download, rename and delete.

Audio- This tab will also have the option to listen to the audio.

Video- This tab will also have the option to view the video properties such as encoding, video length, bitrate, resolution, frames per second, and various other properties.

Images- This tab will also have the option to view the file.

Effects- This tab will have your effect sequences.

Scripts- This tab will have several options.

- View-You can view the script code
- Run-You can run the script code. This is helpful for testing purposes.
- Edit-You can edit the script code from within the browser.
- Copy-You can copy an existing script and save it with a different name. This is useful if you have similar scripts with different options.

Logs- This tab displays a list of several system logs that can be used for troubleshooting. You can view or download an individual log or you can select the Zip option which will bundle all of the system logs into a Zip file and download them onto your computer. (The location it is downloaded to depends on your computer's configuration but is usually in the downloads section) There is also a Tail option for the log which will only output the last 50 lines of the log to get just the most recent log information.

Uploads- This tab will contain any files that do not fit the standard FPP formats.

## Playlists

FPP was originally designed to play playlists, but a playlist can be far more than a list of songs. The playlist is a very versatile function of the FPP. A playlist is an organized group of sequences, events, scripts, videos, etc. that are to be played in a particular order. The playlist is where you combine your sequences, videos, events etc. to create your light show. You can have several playlists so that you can have a different show for certain timeframes or days of the week or any other combination of playlists. You can even have a playlist within a playlist. For example, during the week, you might only want a small portion of your sequences to play and on the weekend, all of your sequences to play. Then you would create 2 playlists with the order of the sequences/events to play for each playlist.

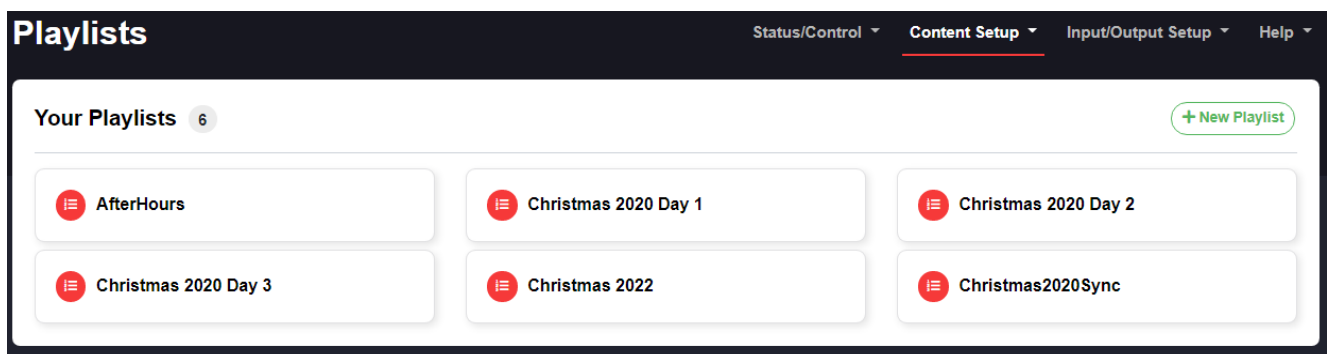

You can select an existing playlist or create a new playlist by clicking on the New Playlist button.

## Add a New Playlist ✕

Playlist Name:

Playlist Description:

Randomize:

Add Playlist

You would enter a Playlist name, you can enter a more descriptive description if you want and if you want the playlist to play in a random order, you can select the Randomize option.

< 📺 Christmas 2020 Day 2 ⚙️ Playlist Actions Save Playlist

---

**Lead In** ITEMS DURATION 1 item 00:00 + Add a Sequence/Entry

1. **Script:** viewer\_control\_on.php

**Main Playlist** ITEMS DURATION 12 items 32:36

ITEMS	DURATION
2. <b>Seq+Med:</b> Show intro.fseq   Show Intro.mp3	Length: 00:55
3. <b>Seq+Med:</b> Let It Snow.fseq   15 - Let It Snow! Let It Snow! Let It Snow!.mp3	Length: 02:00
4. <b>Seq+Med:</b> Tones and I - Dance Monkey.fseq   Tones and I - Dance Monkey.mp3	Length: 02:21
5. <b>Seq+Med:</b> santa tell me.fseq   Santa Tell Me.mp3	Length: 03:24
6. <b>Seq+Med:</b> MilitaryTribute feat Sailor Jerry.fseq   MilitaryTribute feat Sailor Jerry.mp3	Length: 03:53
7. <b>Seq+Med:</b> All I Really Want.fseq   All I Really Want For Christmas III Jon .m4a	Length: 02:51
8. <b>Seq+Med:</b> Donde esta Santa Clause.fseq   08 - Donde Esta Santa Claus_.mp3	Length: 02:25
9. <b>Seq+Med:</b> Heroes in Blue Tribute.fseq   Heroes in Blue Tribute.mp3	Length: 04:41
10. <b>Seq+Med:</b> Papa Mama Loca Pipa.fseq   Papa Mama Loca Pipa.mp3	Length: 01:29
11. <b>Seq+Med:</b> Text Me Merry Christmas.fseq   18 - Text Me Merry Christmas (feat. Kristen Bell).mp3	Length: 02:40
12. <b>Seq+Med:</b> Wizards of Winter(lights Out).fseq   Wizards in Winter (Modified2).mp3	Length: 03:05
13. <b>Seq+Med:</b> Mr Grinch.fseq   Mr Grinch.mp3	Length: 02:46

**Lead Out** ITEMS DURATION 1 item 00:00

14. **Script:** viewer\_control\_off.php

Once you open a playlist you can hover over the playlist name to get an Edit button to edit the Playlist name.

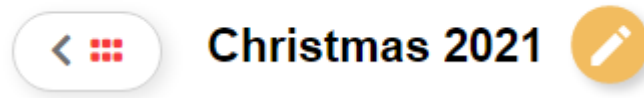

At the top right of the Playlist screen you have some more options.



Settings- This will give you the option to edit some of the settings saved for this Playlist such as the description, Randomize and if you want the playlist to show Verbose details.

The Randomize option will give you some additional options

- Off- The playlist will play in the order that you have configured.
- Once Per Load- This will Randomize the playlist each time the Playlist begins.
- Every Iteration- This will Randomize the entire playlist after each



Playlist Actions- This will give you some additional functions that you can perform on this playlist such as:

- Copy Playlist- This will copy this playlist and give you the option to name the new playlist.
- Rename Playlist- You can rename the current playlist.
- Randomize Playlist- This will place the playlist items in this playlist in a random order.
- Reset Playlist- This will revert this playlist to the saved version.
- Delete Playlist- This will delete the current playlist.

**Save Playlist**

This will save your current playlist.

A Playlist has 3 sections and each section will show the number of items and duration for all of the items in that section at the top of each section.

Lead In- This section will only play once when your playlist first starts. This can be useful to activate items before your show actually begins or a one-time announcement. This will not repeat even if the repeat option is selected in the Scheduler or Status page.

Main Playlist- This section lists your main playlist items and if the repeat option is selected in the Scheduler or Status page this section will repeat until the playlist is stopped.

Lead Out- This section will only play once when your playlist ends. This can be useful to deactivate items that were activated at the beginning of your show or a closing announcement.

To add entries to any of the sections is an identical process. Click on the Add a Sequence/Entry button. You will get several options:

Type- You will select the type of the playlist item you want to enter.

- Sequence and Media - This option is the most common item and is for playing an entry that has both a .FSEQ file and associated media file (music and/or video). You can also select the Video Out option.
- Branch- This option allows you to modify the playlist while it is actually running by branching to other areas of the playlist depending on certain test criteria. This can be used for things like reducing the volume of your output depending on the time of day.

The screenshot shows a 'New Entry' form with the following fields and values:

- Type: Branch
- Test Condition: Time
- Start Time: 00:00:00
- End Time: 00:00:00
- Loop Test: Iteration
- Starting Iteration: 1
- Every: 2 loop iterations
- MQTT Topic: MQTT Topic
- MQTT Message: MQTT Message
- If True: Jump to Offset
- Section: \*\* Same \*\*
- Item: 1
- Playlist: AfterHours
- If False: Jump to Offset
- Section: \*\* Same \*\*
- Item: 1
- Playlist: AfterHours
- Note: (empty)

Buttons: Insert, Add

There are several Test Conditions and settings available for the Branch Entry type.

- Dynamic- This entry is for playlist items that are created from an outside script/plugin or process and allows for items to be played “on the fly”.

The screenshot shows a 'New Entry' form with the following fields and values:

- Type: Dynamic
- Source Type: File
- File: Full File Name of JSON file
- Plugin: remote-falcon
- Host: 192.168.1.100 - FPPMaster
- URL: URL to JSON data
- Drain: (checkbox)
- Queue: (checkbox)
- Note: (empty)

Buttons: Insert, Add

- FPP Command- You can select one of the available FPP commands as a playlist item. (refer to FPP Commands for more information)
- Image- You can display images through the HDMI port. This could be useful if you want to have a virtual “picture frame” You can select all of the images that are in your Images folder by entering /home/fpp/media/images for the path. Or you can select individual images by entering the image file name. You will select the transition type

that you want in between images. Then you would add a Pause Entry for the amount of time that you want the image to display. If you are displaying individual images, you will need to add a Pause entry after each picture for how long you want the image to display before it transitions to the next one. If you select the Images path, FPP will play the images in a random order.

- Media Only- This option is for playing media only when there are not any lights being controlled like displaying pictures on a matrix or TV.
- Pause-You can add a pause to your playlist. This can sometimes be useful if you have other actions going on that you want to pause before the next playlist item is played.
- Playlist-You can embed a playlist within a playlist. One example, you have three different shows you play during the week, but each show has a Lead In playlist of a few songs. You could put the Lead In songs in one playlist and then for the Lead In on each of your three daily playlists, you could just enter the one Lead In playlist instead of recreating the Lead In songs in each playlist.
- Remap- This option will remap channels to another channel range. This is helpful if you move a prop(s) to a different port on a controller and you can't rebuild the sequence.
- Script-You can run a script from within the playlist, there are several pre-written scripts available or you could write your own. (see the Script Repository Browser section for more detail)
- Sequence Only- This option is for playing sequence data only when there is not any media associated with the sequence, like an animated sequence
- URL-This entry will allow you to send URL commands to outside programs or processes. This can be used for things like turning on/off smart power strips or if you have a website, you could send what song is currently playing.

You can rearrange the Playlist items by clicking and dragging them to the order you want them, You can drag them from one section to another as well.

If you hover over any of the Playlist items you will get some additional options to Edit or delete that individual item.

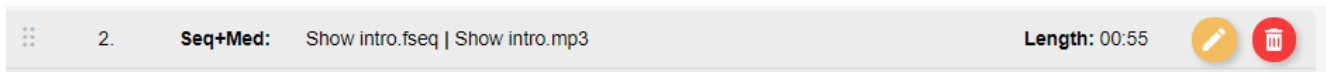

## Scheduler

The Scheduler page is where you can set up predefined playlists to play on a preset schedule. You must have previously created a playlist in order to schedule one. You can have multiple playlists for different days of the week or even different holidays and even different playlists in the same day. The scheduler also supports a priority based schedule where a schedule with a higher priority will preempt a schedule with a lower priority. Priorities are based on the position in the list where a schedule higher on the list has a higher priority. A Playlist can have more than just Sequences, it can have a multitude of commands/options. Note: For the schedule to start on the correct time, you must have your time settings configured properly. (refer to the [Time](#) page in the Status/Control>Settings section of FPP.)

Preview Reload Clear Selection

Delete Clone +Add Save

ACTIVE	START DATE	END DATE	DAY(S)	START TIME	SCHEDULE TYPE	PLAYLIST / COMMAND ARGS	END TIME	REPEAT	STOP TYPE
<input type="checkbox"/>	2020-11-23	2022-01-09	Day Mask S M T W T F S [x][x][x][x][x][ ]	SunSet + 20 min	Playlist	Christmas 2020 Day 1	23:00	Immediate	Graceful
<input type="checkbox"/>	2020-11-23	2022-01-09	Day Mask S M T W T F S [ ] [x][x][x][x][x][ ]	SunSet + 20 min	Playlist	Christmas 2020 Day 2	23:00	Immediate	Graceful
<input checked="" type="checkbox"/>	2020-11-23	2022-01-09	Friday	SunSet + 20 min	Playlist	Christmas 2020 Day 2	23:00	Immediate	Graceful
<input checked="" type="checkbox"/>	2020-11-23	2022-01-09	Day Mask S M T W T F S [ ] [ ] [x][x][x][x][x]	12:00	Playlist	Christmas 2020 Day 3	23:00	Immediate	Graceful
<input checked="" type="checkbox"/>	2020-11-23	2022-01-02	Saturday	SunSet + 20 min	Playlist	Christmas 2020 Day 3	23:00	Immediate	Graceful
<input checked="" type="checkbox"/>	2018-01-01	2025-12-31	Everyday	22:00	Playlist	AfterHours	02:00	Immediate	Graceful
<input type="checkbox"/>	2018-01-01	2025-12-31	Everyday	00:00	Playlist	Christmas 2020 Day 1	12:00	Immediate	Graceful

Disable Scheduler  ?

- Notes:
- If playlist times overlap, items higher in the list have priority.
  - Drag/Drop to change order
  - CTRL+Click to select multiple items
  - Odd/Even for Days is used to alternate playlist over 2 days ?

You can select a schedule by clicking on the Row or selection box (the 6 dots to the far left) and the row will highlight in blue to indicate that it has been selected (three schedules were selected in the above screenshot) To select more than one row, hold down the ctrl key while clicking.

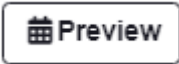

The preview button will give you a graphical view of your saved schedule for the week which could be helpful in identifying scheduling problems.

Schedule Preview

TIME	ACTION	ARGS
Sat Jul 24 @ 12:00 PM	Start Playing	Christmas 2020 Day 3 (Repeating w/ Graceful Stop)
Sat Jul 24 @ 09:37 PM	Start Playing	Christmas 2020 Day 3 (Repeating w/ Graceful Stop)
Sat Jul 24 @ 10:00 PM	Start Playing	AfterHours (Repeating w/ Graceful Stop)
Sat Jul 24 @ 11:00 PM	End Playing	Christmas 2020 Day 3 (Graceful Stop)
Sun Jul 25 @ 02:00 AM	End Playing	AfterHours (Graceful Stop)
Sun Jul 25 @ 10:00 PM	Start Playing	AfterHours (Repeating w/ Graceful Stop)
Mon Jul 26 @ 02:00 AM	End Playing	AfterHours (Graceful Stop)
Mon Jul 26 @ 10:00 PM	Start Playing	AfterHours (Repeating w/ Graceful Stop)
Tue Jul 27 @ 02:00 AM	End Playing	AfterHours (Graceful Stop)
Tue Jul 27 @ 09:33 PM	Start Playing	Christmas 2020 Day 2 (Repeating w/ Graceful Stop)
Tue Jul 27 @ 10:00 PM	Start Playing	AfterHours (Repeating w/ Graceful Stop)
Tue Jul 27 @ 11:00 PM	End Playing	Christmas 2020 Day 2 (Graceful Stop)
Wed Jul 28 @ 02:00 AM	End Playing	AfterHours (Graceful Stop)
Wed Jul 28 @ 12:00 PM	Start Playing	Christmas 2020 Day 3 (Repeating w/ Graceful Stop)
Wed Jul 28 @ 10:00 PM	Start Playing	AfterHours (Repeating w/ Graceful Stop)
Wed Jul 28 @ 11:00 PM	End Playing	Christmas 2020 Day 3 (Graceful Stop)
Thu Jul 29 @ 02:00 AM	End Playing	AfterHours (Graceful Stop)
Thu Jul 29 @ 12:00 PM	Start Playing	Christmas 2020 Day 3 (Repeating w/ Graceful Stop)
Thu Jul 29 @ 10:00 PM	Start Playing	AfterHours (Repeating w/ Graceful Stop)
Thu Jul 29 @ 11:00 PM	End Playing	Christmas 2020 Day 3 (Graceful Stop)
Fri Jul 30 @ 02:00 AM	End Playing	AfterHours (Graceful Stop)
Fri Jul 30 @ 09:29 PM	Start Playing	Christmas 2020 Day 2 (Repeating w/ Graceful Stop)
Fri Jul 30 @ 09:30 PM	Start Playing	Christmas 2020 Day 2 (Repeating w/ Graceful Stop)
Fri Jul 30 @ 10:00 PM	Start Playing	AfterHours (Repeating w/ Graceful Stop)
Fri Jul 30 @ 11:00 PM	End Playing	Christmas 2020 Day 2 (Graceful Stop)
Sat Jul 31 @ 02:00 AM	End Playing	AfterHours (Graceful Stop)

Note: This schedule potentially identifies some errors. Each schedule is color coded to see the start and stop times and stop modes. If your colors are not in pairs, it MIGHT indicate a problem but that isn't always the case if you are using the Priority functionality of the Scheduler.



The reload button will reload this page with your saved schedule. So if you make changes but have not saved them, this will load what is currently saved to take you back to the beginning.

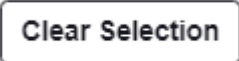

If you have any line items selected in the Scheduler section, this will deselect all items.



This will delete any rows that you have selected. This action is not final until you click on the Save button.

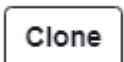

This will clone (copy) any of the selected item and put them at the bottom of your schedule page.



The Save button must be clicked after any additions/modifications in order for them to be saved.



To create a schedule, click on the Add button and then fill in the items pertaining to the playlist (to edit an existing playlist, just modify the sections as needed)

Active-This will allow you to select whether you want this playlist to be active or not. You might have playlists that you want to create to be used at a later date but don't want them to be active now.

Start Date-This is the date that you want the chosen playlist to start playing. This can be a date way in the past and the playlist will play when the next start Time/Day is reached. If you configured your Locale in the [FPP Settings>System](#) selection, you can select holidays by name instead of entering the dates manually.

End Date-This is the last day that you want the playlist to play. It can be far into the future if you desire. The playlist will stop playing after the selected end date. If you configured your Locale in the [FPP Settings>System](#) selection, you can select holidays by name instead of entering the dates manually.

Days(s)-You can select any combination of days for your playlist to play. Several of the more common day combinations are listed in the drop down. If the combination you want is not listed, then select the Day Mask and place a check next to the days that you want the playlist to play.

DAY(S)



**Start Time**-This is the time that you want your playlist to begin. The time has to be entered in the format you have configured in the [Time](#) Settings, it will default to a 24 hour format.. When you click on the Start Time box, there will be listed start times for every half hour. You do not need to select one of those times; you can enter any time that you want. There are also options to coincide with the daylight for your area such as Dawn, SunRise, Sunset and Dusk that you can select which will adjust the start time to coordinate with your local Sunrise/Sunset times. In order for this to work properly, you will need to have your Time configurations set up correctly to include your Latitude and Longitude coordinates (see the [FPP Settings>System](#) section.)

**Schedule Type**- A schedule doesn't have to be an actual playlist, you can select a Single sequence or FPP Command if that is what you need.

**Playlist/Command Args**-This is the playlist or FPP Command that you want to play during the selected timeframe. Note, an FPP Command does not have an end time. It will trigger at the start time and be completed at that time.

**End Time**-This is the time that you want your playlist to end. If there is a sequence playing when it reaches this time, the sequence will end according to the Stop Type you have selected. The time has to be entered in the format you have configured in the [FPP Settings>Time](#), it will default to a 24 hour format. When you click on the End Time box, there will be listed end times for every half hour. You do not need to select one of those times; you can enter any time that you want. There are also options to coincide with the daylight for your area such as Dawn, Sun Rise, Sunset and Dusk that you can select which will adjust the end time to coordinate with your local Sunrise/Sunset times. In order for this to work properly, you will need to have your Time configurations set up correctly to include your Latitude and Longitude coordinates (see the [FPP Settings>System](#) section.) If your schedule is to go beyond midnight, select the end time that you want your schedule to end. FPP will understand that the end time is actually on the next day and stop accordingly.



Repeat-There are 3 repeat types to select.

- None- With this option selected, the playlist will only play once.
- Immediate- With this option selected the Main playlist will continue from the beginning when it is finished and keep repeating the Main playlist until the scheduled end date/time is reached. This might need to be checked if there is a possibility that a previously scheduled playlist might still be playing when this playlist is scheduled to start (like in a Graceful Stop situation.)
- Timed- The playlist is scheduled to run Once every 'x' minutes. This includes running the Lead In, Main Playlist, and Lead Out sections each iteration. If you look at the schedule preview, you will see multiple instances of the playlist scheduled, starting with the first instance at the scheduled start time and repeating another instance every X minutes up until the scheduled end time. If the playlist is longer than the scheduled repeat interval then the running instance will stop when the repeat interval hits and a new instance will be started. If the playlist is shorter than the scheduled repeat interval, then the playlist will complete and won't start again until the repeat interval rolls around.

Stop Type- There are three Stop Types that you can select from.

- Graceful- This will play the song that is currently playing and then stop, if you have a Lead Out section, that will also play so it is possible that your schedule will not end on the exact time selected.
- Graceful Loop- This will complete the current playlist (including Lead Out section) and then stop.
- Hard Stop- This will end the playlist at the time scheduled. If a song is playing, it will stop in the middle of the song. If you have a Lead Out section, it will not play.

Note: If a playlist does not have the Repeat option selected

- It will only start if there is no other sequence playing at the scheduled start time.
- It will play all of the sequences in the list and then stop. If the schedule for this playlist ends before all of the sequences have played, then when the end time is reached, the currently playing sequence end time will be based on the Stop Type you selected. The rest of the items in the playlist will not get played. It is probable that the playlist will not end exactly on the scheduled end time.

**Note: If a playlist does have the Repeat option selected**

- Then it will start at the scheduled start time if there is no other sequence currently playing, or start when the currently playing sequence ends as long as it is within the scheduled time frame.
- It will play all of the sequences in the list and then start over at the beginning of the main playlist and continue until the end time of the schedule has been reached. When the end time is reached, the currently playing sequence in the list will end based on the Stop Type selected. It is probable that the playlist will not end exactly on the scheduled end time.

Updating a Playlist/Schedule- If you update a Playlist/Schedule during a time period that it was scheduled to play then there are a few things to consider.

- If you upload new sequences and add them to a playlist that is currently playing, they will not play in the current cycle and if the Playlist is scheduled to repeat, it will play in the next cycle.

Repeating Schedules- You can create a schedule in FPP that is a continuously repeating schedule based on a certain criteria that will span every month or every year. This is helpful for people that use FPP for more than holiday lighting or more specialized schedules (like landscape or other types of lighting). FPP will ignore any specific field comparisons if there is a 0 entry in a particular field, i.e. 00 for Month and 0000 for year.

For example, here are a couple schedules:

Start Date	End Date	Result
0000-02-14	0000-02-14	Plays every February 14th (Valentine's Day)
0000-00-01	0000-00-07	Plays the first week of every month

You can also have a 24 hour schedule by entering a date in the Past and a date way in the future and set the start time to be 00:00:00 and end time of 24:00:00.

## Priority Scheduling

FPP supports a priority scheduling concept. If there is a schedule playing and a schedule with a higher priority (higher on the list) is scheduled to start, the higher priority schedule will start either immediately or when the current sequence finishes playing depending on the stop strategy that the lower priority playlist is configured. If a playlist has a stop strategy of Hard stop, then a schedule with a higher priority will immediately interrupt the playlist that is playing. If a playlist has a stop strategy of Graceful then a schedule with a higher priority will let the song that is playing complete and then the higher priority schedule will start. If a playlist has a stop strategy of Graceful loop then a schedule with a higher priority will start when the lower priority playlist has completed the entire playlist.

## Script Repository Browser

Scripts are small program codes to perform specific functions that have a wide range of functionality. There are several scripts available from FPP or you could write your own.

The screenshot shows the 'Script Repository' interface. At the top, there are navigation tabs: 'Status/Control', 'Content Setup' (which is active), 'Input/Output Setup', and 'Help'. Below the tabs is a list of scripts, each with a 'View' button and an 'Install' button. The list includes:

- Enable\_HiFiBerry.sh**: Category: Config, Description: Script to enable support for a HiFiBerry DAC on the Pi.
- CheckIfPlaying.sh**: Category: Control, Description: Run scripts based on whether or not FPP is currently playing a sequence of some sort.
- CycleRandomPlaylists.sh**: Category: Control, Description: Randomly cycle through playlists.
- CycleRandomSequences.sh**: Category: Control, Description: Randomly cycle through sequences.
- GoToNextPlaylistItem.sh**: Category: Control, Description: Jump to the next item in the current playlist.
- GoToPreviousPlaylistItem.sh**: Category: Control, Description: Jump to the previous item in the current playlist.

The Script Repository lists the scripts by category based on the functionality of the script. Scripts can be used as a part of a playlist or as part of a plugin. You can install the script or view the actual script code from this screen. Once the script is installed, it can be managed from the File Manager section of the FPP. You may be required to edit some scripts to make them functional. For example, the Remote Control example scripts need to be modified to include the IP address of the remote FPP instance that you wish to control.

NOTE: your DNS settings must be configured and working in order to view the Script Repository.

## Plugin Manager

Plugins are additional components that have been developed by the developers or individuals to provide functionality that can then be used from within the FPP. You can develop your own Plugin or install a Plugin from a third party if you wish. These are used to perform more complex operations than scripts.

The Plugin page has 5 sections in order to ease navigation.

## Retrieve Plugin Info

This section is where you can enter the URL for a Plugin that has not been incorporated into the official release of FPP and FPP will download the relevant information from the plugin. The URL needs to point to the location that the pluginInfo.json file for the plugin is located. If there isn't a valid pluginInfo.json file, the plugin will not be installed.

Once you enter a valid address, you will get the Get Plugin Info button

<https://raw.githubusercontent.com/FPP-Super-Fabulous-Plugin/pluginInfo.json>



## Installed Plugins

This section contains plugins that have been installed and next to the plugin there are several options.

### Installed Plugins

<b>Remote Falcon</b> ✔ Installed	<b>AUTHOR:</b> James Vance - Driftwood Light Show	<b>DESCRIPTION:</b> Allows remote control of FPP from the Remote Falcon web application ( <a href="https://remotefalcon.com">https://remotefalcon.com</a> )	<b>📢 Updates Available</b> <b>🔄 Update Now</b> <b>🔄 Check for Updates</b> <b>🗑 Uninstall</b>
<a href="https://github.com/whitesoup12/remote-falcon-plugin">https://github.com/whitesoup12/remote-falcon-plugin</a>		<a href="#">📄 View Source</a> <a href="#">🐛 Report a Bug</a>	

The section will inform you if there is an update available and give you a button to update if you want.

You also have the option to uninstall the plugin

At the bottom left is a link to take you to the homepage for the Plugin and can be useful for installation information.

<https://github.com/whitesoup12/remote-falcon-plugin>

At the bottom towards the right is a link to take you to the Source code page for the plugin.

[📄 View Source](#)

At the bottom right is a link to report bugs for this plugin.

[🐛 Report a Bug](#)

## Available Plugins

This section contains plugins that are directly available through the FPP interface but haven't been installed. To install the plugin, click on the install icon.

### Available Plugins

<b>Si4713/Vast V-FMT212R</b>	<b>AUTHOR:</b> Daniel Kulp	<b>DESCRIPTION:</b> RDS/Audio support for the Vast Electronics V-FMT212R USB FM Transmitter and Si4713 I2C modules	<b>📥 Install</b>
<a href="https://github.com/FalconChristmas/fpp-vastfmt">https://github.com/FalconChristmas/fpp-vastfmt</a>		<a href="#">📄 View Source</a> <a href="#">🐛 Report a Bug</a>	
<b>Big Buttons</b>	<b>AUTHOR:</b> Chris Pinkham (CaptainMurdoch)	<b>DESCRIPTION:</b> This plugin displays multiple big buttons in a grid on a page. Each button can be individually configured to run a different user script. The title and color of each button can also be configured.	<b>📥 Install</b>
<a href="https://github.com/FalconChristmas/fpp-BigButtons">https://github.com/FalconChristmas/fpp-BigButtons</a>		<a href="#">📄 View Source</a> <a href="#">🐛 Report a Bug</a>	

Note: Most plugins will require some sort of configuration or setup before they will operate correctly. The plugin author will determine which menu heading the plugin should fall under. The plugin's configuration and other relevant pages will be located at the bottom of the menu dropdown. There might be more than one plugin page for the plugin.

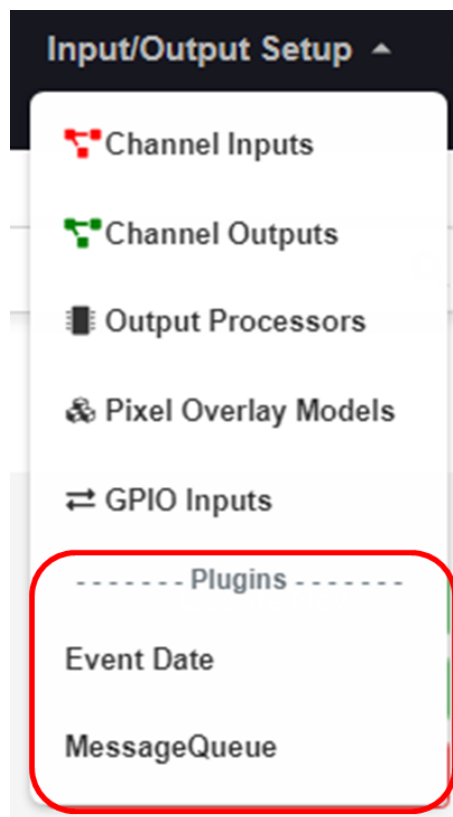

Refer to the plugin's home page or help page for more information on the configuration and usage of the plugin. Some of the more common plugins have setup instructions in the [Common Plugins](#) section of this manual.

## Template Plugin

This section is to assist plugin authors in creating a plugin for FPP and the structure required for a FPP Plugin. See the [Plugin Development](#) section in the Advanced Settings section for more details on creating a Plugin.

### Template Plugin

<b>Template Plugin for FPP Plugin developers</b>	<small>AUTHOR:</small> John Doe (jdoe)	<small>DESCRIPTION:</small> This template plugin is designed to make it easier for plugin authors to create new FPP Plugins. You can manually clone the git repository or install the Template Plugin and then go to the plugin's config page and use the form to copy the template into a new plugin directory.	<a href="#">Install</a>
<small>🏠 <a href="https://github.com/FalconChristmas/fpp-plugin-Template">https://github.com/FalconChristmas/fpp-plugin-Template</a></small>		<small>🔗 <a href="#">View Source</a> 🐛 <a href="#">Report a Bug</a></small>	

## Incompatible Plugins

This section will list available plugins that have compatibility issues with the installed version of FPP. You can go to the developer's website and view the code and possibly fix the code to make it work for your application.

# Input/Output Setup

The Input/Output section is used primarily to define the channel/universe configurations of the controller connected to the FPP. It is also used to configure other input or output configurations.

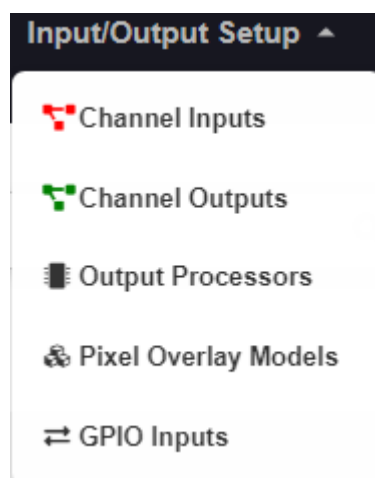

## Channel Inputs

The Channel Inputs section is to identify incoming data this FPP should be “listening to”. DDP inputs do not need to be configured and you should not enter E1.31/ArtNet Universes that other FPPs are using. Configuring/Enabling inputs is useful if you want to control your lights/props directly from xLights, xSchedule or other software and is useful in testing from xLights as well. If you are not going to use an outside device to send the pixel data, then you don't need to configure/enable the inputs but it could be helpful in testing.

If you want FPP to process the E1.31/ArtNet/DDP data coming in and pass it through the selected network port to a controller or other E1.31 device, you will need to enable the input and if it is E1.31/ArtNet data, then you will need to configure the input(s). If you have events or other output processes that are triggered by channel data, they will be processed.

**Note: xLights will enable the inputs if you use the Output to lights Function.**

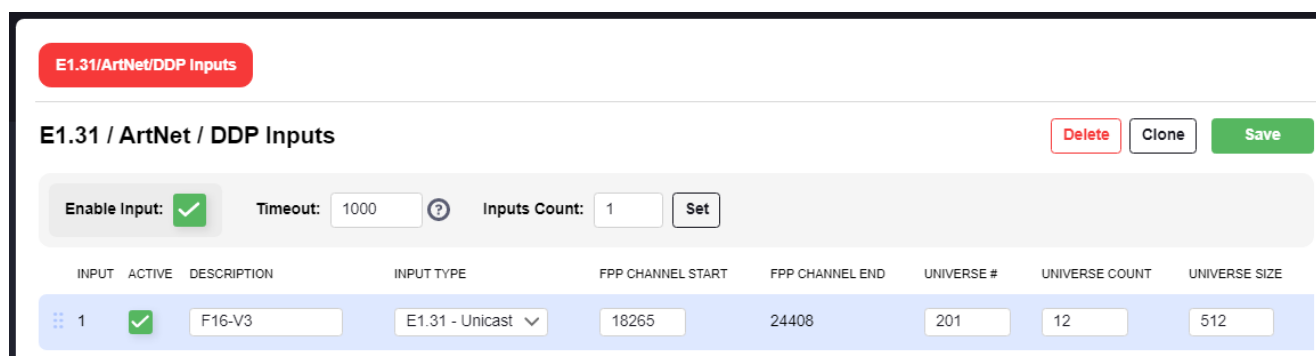

**(Note: if you are using DDP, then you do not need to configure any inputs, just enable the input. FPP will automatically receive and recognize DDP packets with no configuration needed)**

Enable Input- This will enable FPP to process incoming channel data.

Timeout- If your FPP device is processing inputs, you can enter a time in seconds that a blanking signal will be sent out if no E1.31/DDP/Artnet signal is received in the timeout setting.

Inputs Count- This box is used to set the total number of lines that you want to configure as inputs and will populate the window below when the Set button is pressed.

Input- This is just a reference for the line.

Active- You can make the Universes defined on a line active by selecting this box, if you don't want it active, remove the checkmark.

Description- Enter a description to help you identify the controller that these Universes are assigned.

Input Type- Enter the input type that this FPP device will be receiving, it is usually best to select E1.31 Unicast.

FPP Channel Start- Enter the Start Channel that you want these Universes to start, if this is the only controller in your network, then it is typically 1 but if you have more than one controller, you will have to determine what the start channel should be. This can usually be determined from your xLights Setup screen.

FPP Channel End- This will be calculated based on the information entered.

Universe #- This is the first Universe number that you are assigning. It can be any number from 1-63999 and doesn't need to begin at 1.

Universe Count- Enter the number of Universes you are going to assign to this FPP device. Universes do not have a direct correlation to ports, it is recommended to define Universes based on controllers and only define the number of Universes you actually need. In the screenshot above, there are 12 Universes of 512 channels defined.

Universe Size- Enter the number of channels that you want each Universe to have. The common Universe size is either 512 or 510 channels and they both work equally well. Just make sure that you use the same Universe numbers and sizes in all areas related to this FPP device (xLights, etc.)

Your E1.31/Artnet Universes/FPP Start channels/Universe sizes need to match what you set up in your Sequencer, Show player (e.g. xLights/xSchedule) and the controller. If you need additional information on Universes, channels etc. refer to the Resources section about [Universes, Channels and Ports, oh my!](#).

**Important! If you change the FPP Start Channel numbers, Universe #, Universe Count or Universe size after you have configured your Universes, make sure that you adjust any of the other Universe Lines because FPP will not "auto correct" your Universe #s or FPP Start Channel numbers.**

# Adding E1.31/Artnet Inputs

## E1.31/Artnet/DDP Inputs

### E1.31 / Artnet / DDP Inputs

Delete Clone Save

Enable Input:  Timeout: 1000 ? Inputs Count: 1 Set

INPUT ACTIVE DESCRIPTION INPUT TYPE FPP CHANNEL START FPP CHANNEL END UNIVERSE # UNIVERSE COUNT UNIVERSE SIZE

(Drag entry to reposition)

If you need to enter E1.31/Artnet Universes, you would normally enter 1 for the Inputs count and click on Set. Then enter all of the relevant information in the fields that get displayed.

The Clone button will copy the settings of the selected Line # (Universe #, Universe Count, Universe Size and Universe Type) to the lines below. FPP will then ask how many Universe lines you want to clone. This is not normally needed with the ability to define several Universes on one line.

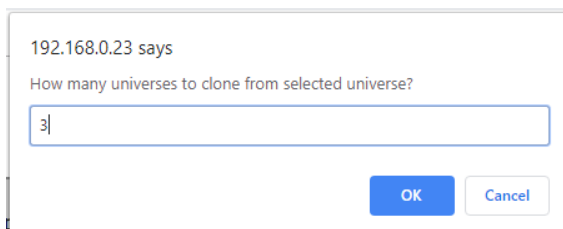

When you click OK, FPP will paste the settings into the number of Universe lines that you entered below the selected Universe line and increment the Universe # on each cloned line.

Note: You have to enter a valid number of Universes to clone. If you select more Universes to clone than there are Universe lines below the selected Universe, then the clone process will not be completed.

You can also delete a Universe line by selecting it and clicking on the Delete button.

**Important! You have to click on the Save button after you make any changes in order for them to be saved. After you save the configuration, you will get a message at the top of your screen indicating that you have to restart FPP for the change to take effect.**

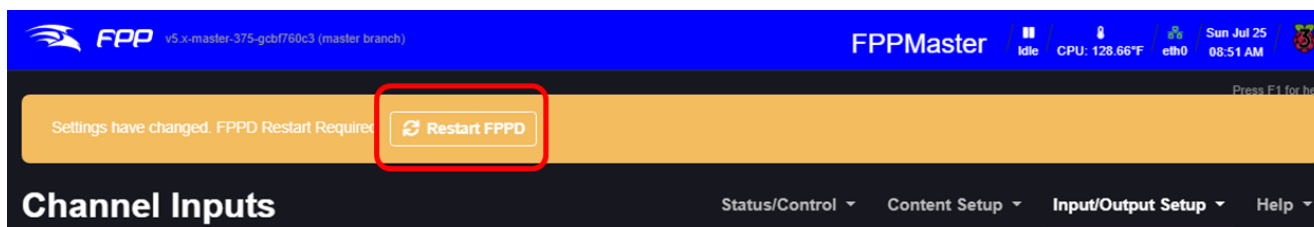



# Channel Outputs

The Channel Outputs page is where you configure FPP to output the channel data to the various controllers/hats/capes that are connected to the FPP. There are several types of output configurations and you will have to configure the output that is appropriate for your application. Depending on the SBC (Pi or BeagleBone or if you have a cape for LED panels installed), the Channel Output tabs will be different.

## Pi Channel Outputs

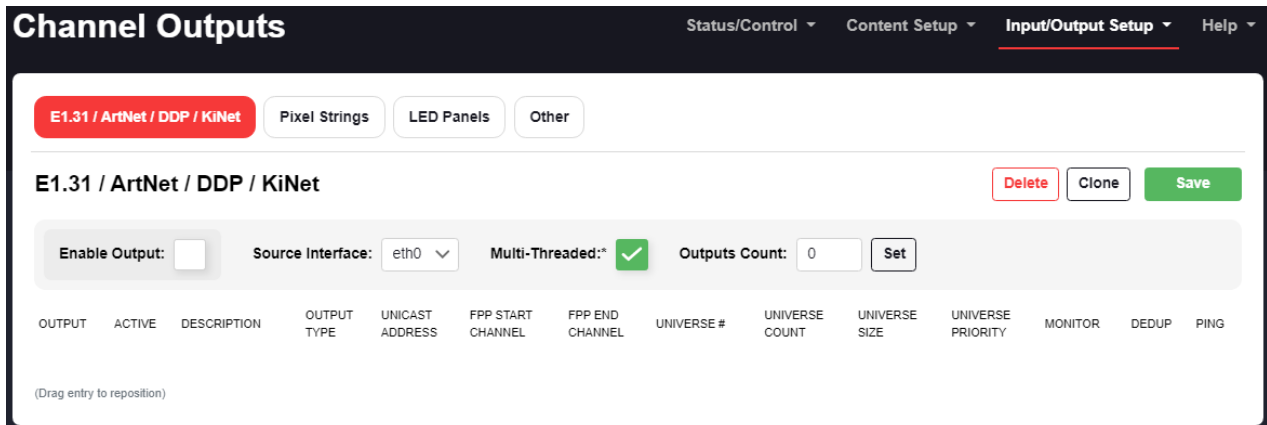

## BeagleBone Channel Outputs

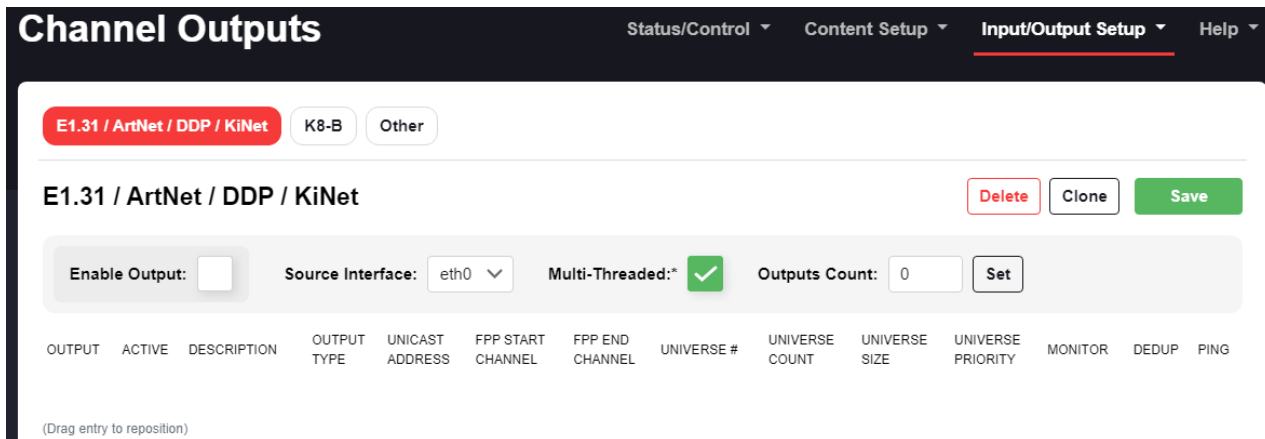

You will need to set up your channel outputs to match the controller that is connected to your FPP device and the settings in your Sequencing software.

Here are the Channel output types and typical usage.

- E1.31/Artnet/DDP/KiNet- If your FPP device is connected **with an Ethernet cable to a controller** (or switch that is connected to controllers) that are using E1.31/Artnet, DDP, or KiNet data, then you will need to configure the outputs in this tab. DDP is the preferred protocol if you have a controller that supports DDP (e.g. KulpLights.com. ESP PixelStick controllers)

- Pixel Strings- If you are using a Pi Hat or BeagleBone Cape then you would configure the outputs on this tab. There are several capes that you can add to the BeagleBone series SBC to control up to 40 ports. FPP will use the attached cape info, if available, to create the correct type of Output page (K8-B in this screenshot) If you have a KulpLights controller, this is where you will configure the ports for it. If the type of cape is not identified, you will get a Generic BBB String page. **Note: if you have Pixel Strings enabled on a Pi device, then the onboard audio will be disabled.**
- LED Panels- This is for setting up P10/P5 panels that are connected to either a BB OctoScroller type controller or a Pi Matrix hat type controller.
- Other-There are several other output types that are not commonly used but available, such as DMX Pro, LOR, Renard, Pixelnet, GPIO, etc. to name a few.

## E1.31/ ArtNet/ DDP/KiNet

**Note: You only need to configure/enable E1.31/ArtNet/DDP/KiNet outputs if this device is going to send pixel data to external devices across the network. This does not apply to locally attached Hats/Caps/Capes or Serial DMX ports**

Your E1.31 Universes/FPP Start channels/Universe size needs to match what you configured in your show sequencer (e.g. xLights) and the controller. If you need additional information on Universes, refer to the Resources section about [Universes, Channels and Ports, oh My!](#)

You can use [FPP Connect](#) in xLights to upload your configuration and this is the recommended method. This helps prevent typographical errors in copying the information.

You only need to Enable and Configure E1.31/Artnet/DDP outputs if you need this FPP device to send out E1.31 data through one of its network interfaces. If you have an attached Cape/Hat or running in a Player/Remote mode, you usually do not need to Enable/Create E1.31/ArtNet/DDP outputs.

If you are using xLights, you can export the E1.31/ArtNet/DDP Channel Output settings into your FPP by using the FPP Connect feature in the Tools section of xLights by selecting the UDP option.

**Warning: If you are not going to use FPP to send E1.31/ArtNet/DDP data and you select the UDP option in FPP Connect, FPP Connect will configure AND ACTIVATE your E1.31 outputs this could cause lagging and unexpected results if you don't need to output E1.31 data.**

## E1.31 / ArtNet / DDP / KiNet

Delete

Clone

Save

Enable Output:  Source Interface: eth0 Multi-Threaded:  Outputs Count: 7 Set

OUTPUT	ACTIVE	DESCRIPTION	OUTPUT TYPE	UNICAST ADDRESS	FPP START CHANNEL	FPP END CHANNEL	UNIVERSE #	UNIVERSE COUNT	UNIVERSE SIZE	UNIVERSE PRIORITY	MONITOR	DEDUP	PING
1	<input checked="" type="checkbox"/>	F16V3-Yard	E1.31 - Unicast	192.168.101.2	1	12288	100	24	512	0	<input checked="" type="checkbox"/>	<input type="checkbox"/>	Ping
2	<input type="checkbox"/>	F8PB-LeftRoof	DDP - Raw Char	192.168.1.102	12289	15357	200	1	3069	0	<input checked="" type="checkbox"/>	<input type="checkbox"/>	Ping
3	<input type="checkbox"/>	F8PB-RightRoof	DDP - Raw Char	192.168.1.103	15358	16335	300	1	978	0	<input checked="" type="checkbox"/>	<input type="checkbox"/>	Ping
4	<input type="checkbox"/>	PocketScroller	E1.31 - Unicast	192.168.1.104	16336	30159	400	27	512	0	<input checked="" type="checkbox"/>	<input type="checkbox"/>	Ping
5	<input type="checkbox"/>	F8PB Singing Eleme	DDP - Raw Char	192.168.1.105	30160	33111	500	1	2952	0	<input checked="" type="checkbox"/>	<input type="checkbox"/>	Ping
6	<input type="checkbox"/>	F8-PB Matrix	DDP - Raw Char	192.168.1.106	33112	46083	600	1	12972	0	<input checked="" type="checkbox"/>	<input type="checkbox"/>	Ping
7	<input checked="" type="checkbox"/>	F8-Backup	E1.31 - Unicast	192.168.1.107	46084	46593	1	1	510	0	<input checked="" type="checkbox"/>	<input type="checkbox"/>	Ping

- Enable Output- If you need your FPP to output data to the network, then make sure you check the box to enable E1.31/Artnet/DDP output.
- Source Interface- Select the interface that you want the data to be sent out, this is typically eth0.
- Multi-Threaded- Most processors support Multi-Threading which is more efficient. This should normally be enabled, (**note: This is only visible with an Advanced or higher level setting in the UI tab.**)
- Outputs Count- This indicates the number of Outputs that are configured. This is typically the number of controllers that this FPP is sending data to. This will set the number of lines to the number you selected and the recommended method is to use only one line per controller/FPP device (even when that controller uses multiple universes).
- Set Button- Clicking on the Set button will change the number of outputs in the Outputs section and FPP will populate the outputs screen with the number of lines you entered in the Output Counts and then you can modify them as needed.
- Save button- This will save your changes.
- Clone button- This will make a copy of the selected output and paste the information into the line items below it (you need to have enough output lines for the number of clones you are configuring).
- Delete button- This will delete the selected output.
- Output- This is used to identify each line of Output(s) saved on your FPP.
- Active- An Output line can be Active or not. If it is not active then data will not be transmitted to all the universe(s) on that Line #. It is important to only activate the outputs that are actually needed by this FPP device.
- Description-This can be used to provide information on how each Universe Line # is assigned. This is usually something to identify the controller.
- Output Type- This is used to identify how the Universe Data is going to be transmitted. This is normally DDP, E1.31 Multicast or E1.31 Unicast with DDP being the recommended method for devices that support the DDP protocol. For specialty configurations it can be set for Artnet. E1.31 data should typically be set to Unicast for better efficiency. DDP Data is normally configured for Raw Channel numbers. DDP-One Based will convert the output data for each controller/FPP device to begin on channel one, and if you select this option, you will need to manually configure those FPP devices/Controllers to match this configuration.
- Unicast Address- If you are using Unicast or DDP data, then the IP address of the device you are sending the data to needs to have it entered in this box.

- FPP Start Channel-This is the Absolute Channel that is configured in your Sequencing Program for that range of Universes (xLights, Vixen, etc.)
- FPP End Channel-This is calculated based on the information you entered to help verify that the information you entered is correct.
- Universe #- This shows the starting universe number for the Channel OutputLine #.
- Universe Count-This will indicate how many Universes are defined for that line. You can define multiple Universes on a line and this is the recommended method.
- Universe Size- This is how many channels each Universe is designated. All Universes on that line will have the same number of channels. It is more common to use either 512 or 510 but you need to make sure you use the same numbering system for all interfaces in your show, such as your Scheduling program and your player program.
- Universe Priority- You can select a priority for the E1.31 data packets. If a device receives E1.31 data from 2 sources, then the device will use the one with the highest priority. This is only valid for controllers that support the E1.31 priority function and is not very common.
- Monitor- If you select this option, FPP will monitor the device that is receiving the E1.31 data and if it becomes unavailable it will stop sending the data until the device starts to respond again.
- DeDup- By selecting this option, FPP will use an algorithm for sending data packets and if a packet is a duplicate of the previously sent packet, FPP will not send the duplicate packet. This helps reduce the bandwidth used on your network.
- Ping- You can click this button to verify that your network configurations are set correctly

**Important! If you change the FPP Start Channel numbers, Universe #, Universe Count or Universe size after you have configured your Universes, make sure that you adjust any of the other Universe Lines because FPP will not “auto correct” your Universe #s or FPP Start Channel numbers.**

## Pixel Strings

If you are using a Hat or Cape type of controller, wiring directly to the GPIO pins or a generic BeagleBone based controller, you will set up your channel outputs here.

### Pi Based outputs

The outputs page for Pi based hats (controllers) or when you are going to connect directly to the GPIO pins, will look like this:

E1.31 / ArtNet / DDP / KiNet
Pixel Strings
LED Panels
Other

Revert
Clone String
Save

Enable String Cape:  Cape Type: PiHat ▼

Press F2 to auto set the start channel on the next row.

PORT	PROTOCOL	DESCRIPTION	START CHANNEL	PIXEL COUNT	GROUP COUNT	END CHANNEL	DIRECTION	COLOR ORDER	START NULLS	END NULLS	ZIG ZAG	BRIGHTNESS	GAMMA
1)	ws2811	<span style="color: green;">+</span>	<input type="text" value="1"/>	<input type="text" value="0"/>	<input type="text" value="1"/>	<input type="text" value="0"/>	Forward <span>▼</span>	RGB <span>▼</span>	<input type="text" value="0"/>	<input type="text" value="0"/>	<input type="text" value="0"/>	100% <span>▼</span>	1.0
2)	ws2811	<span style="color: green;">+</span>	<input type="text" value="1"/>	<input type="text" value="0"/>	<input type="text" value="1"/>	<input type="text" value="0"/>	Forward <span>▼</span>	RGB <span>▼</span>	<input type="text" value="0"/>	<input type="text" value="0"/>	<input type="text" value="0"/>	100% <span>▼</span>	1.0

- Enable String Cape- Check this box to enable the Pi Pixel String output. You can uncheck this box to disable the string outputs without losing the configuration.
- Cape Type- Select the cape type that you are going to be connecting to your Pi. You can choose between PiHat, rPi-28D+ or spixels. PiHat is used for most pixels such as WS2811, WS2812, etc. protocol. This type can control two strings of ws281x pixels. Spixels can drive 16 independent strings of APA102, LPD6803, or LPD8806 pixels directly off the Raspberry Pi's GPIO ports by emulating SPI outputs in software. The data and ground lines attach directly to the Pi while power for the pixels is injected from another source.
- Revert- Selecting this will revert the screen to the currently saved configuration
- Clone String- Selecting this will copy the settings of the selected string to the number of strings selected below. It will update the Start Channel to follow after the previous string.
- Save- Selecting this will save your configuration.
- Port- Indicates the number of the output port on the hat.
- Protocol- Indicates the protocol for the pixels attached to the port of the hat.
- Description- You can enter a description for the pixels attached to the port.
- Start Channel- Enter the start channel that corresponds to the start channel in your sequencing software (xLights, Vixen, etc.)
- Pixel Count- Enter the number of pixels connected to that port of the hat.
- Group Count- If you have groups of pixels that are going to be illuminated exactly the same all of the time, you can put them in groups.
- End Channel- This indicates the ending channel for the string.
- Direction- Selecting reverse will reverse the data sent to the pixels so that it will act like the data is coming in from the end of the string.
- Color Order- You can select a color order to match the color order for the pixels you are using.
- Start Nulls- If you are using Null Nodes in the beginning of your string to help boost the transmission distance, then enter the number of Null Nodes you have in that section of the string.
- End Nulls- If you are using Null Nodes at the end of your string to help boost the transmission distance, then enter the number of Null Nodes you have in that section of the string.
- Zig Zag- This setting is useful for items like a Mega Tree where one string is used for more than one strand of the tree. This is more commonly set up in the sequencing software (xLights, Vixen, etc.) Enter the number of times the string changes direction.  
**Do not use Zig Zag if you used the Strands/String setting in your sequencing software.**
- Brightness- You can set the brightness for your pixel string. Many dense props are very bright and a lower brightness might look better. This also reduces the power required to light the pixels.
- Gamma- This is a correction factor that can be entered due to the way that our eyes perceive color and brightness in a non-linear way. It can also be used to correct color variations on pixel strings from different vendors.

## BeagleBone Based Outputs

The BeagleBone series of SBCs has several capes and configurations and is very versatile. There are several capes available from <http://kulplights.com>. FPP will usually identify the attached cape and configure this page accordingly.

## Generic BeagleBone Outputs

E1.31 / ArtNet / DDP / KiNet

Pixel Strings

LED Panels

Other

### String Capes

Revert

Clone String

Save

Enable String Cape:

Cape Type: F8-B (No Serial)

Version: 1.x

Pixel Timing: Normal (ws281x)

Press F2 to auto set the start channel on the next row.

PORT	DESCRIPTION	START CHANNEL	PIXEL COUNT	GROUP COUNT	END CHANNEL	DIRECTION	COLOR ORDER	START NULLS	END NULLS	ZIG ZAG	BRIGHTNESS	GAMMA
1)	<input type="text" value="SingingTree5"/>	<input type="text" value="46594"/>	<input type="text" value="246"/>	<input type="text" value="1"/>	<input type="text" value="47331"/>	Forward <input type="text"/>	RGB <input type="text"/>	<input type="text" value="0"/>	<input type="text" value="0"/>	<input type="text" value="0"/>	20% <input type="text"/>	1.0
	<input type="text" value="Mega Tree-2-str-1"/>	<input type="text" value="47332"/>	<input type="text" value="300"/>	<input type="text" value="1"/>	<input type="text" value="48231"/>	Forward <input type="text"/>	RGB <input type="text"/>	<input type="text" value="0"/>	<input type="text" value="0"/>	<input type="text" value="0"/>	100% <input type="text"/>	1.0
2)	<input type="text" value="Mega Tree-2-str-2"/>	<input type="text" value="48232"/>	<input type="text" value="300"/>	<input type="text" value="1"/>	<input type="text" value="49131"/>	Forward <input type="text"/>	RGB <input type="text"/>	<input type="text" value="0"/>	<input type="text" value="0"/>	<input type="text" value="0"/>	100% <input type="text"/>	1.0
3)	<input type="text" value="Mega Tree-2-str-3"/>	<input type="text" value="49132"/>	<input type="text" value="300"/>	<input type="text" value="1"/>	<input type="text" value="50031"/>	Forward <input type="text"/>	RGB <input type="text"/>	<input type="text" value="0"/>	<input type="text" value="0"/>	<input type="text" value="0"/>	100% <input type="text"/>	1.0
4)	<input type="text" value="Mega Tree-2-str-4"/>	<input type="text" value="50032"/>	<input type="text" value="300"/>	<input type="text" value="1"/>	<input type="text" value="50931"/>	Forward <input type="text"/>	RGB <input type="text"/>	<input type="text" value="0"/>	<input type="text" value="0"/>	<input type="text" value="0"/>	100% <input type="text"/>	1.0
5)	<input type="text" value="Mega Tree-2-str-5"/>	<input type="text" value="50932"/>	<input type="text" value="300"/>	<input type="text" value="1"/>	<input type="text" value="51831"/>	Forward <input type="text"/>	RGB <input type="text"/>	<input type="text" value="0"/>	<input type="text" value="0"/>	<input type="text" value="0"/>	100% <input type="text"/>	1.0
6)	<input type="text" value="Mega Tree-2-str-6"/>	<input type="text" value="51832"/>	<input type="text" value="300"/>	<input type="text" value="1"/>	<input type="text" value="52731"/>	Forward <input type="text"/>	RGB <input type="text"/>	<input type="text" value="0"/>	<input type="text" value="0"/>	<input type="text" value="0"/>	100% <input type="text"/>	1.0
7)	<input type="text" value="Mega Tree-2-str-7"/>	<input type="text" value="52732"/>	<input type="text" value="300"/>	<input type="text" value="1"/>	<input type="text" value="53631"/>	Forward <input type="text"/>	RGB <input type="text"/>	<input type="text" value="0"/>	<input type="text" value="0"/>	<input type="text" value="0"/>	100% <input type="text"/>	1.0
8)	<input type="text" value="Mega Tree-2-str-8"/>	<input type="text" value="53632"/>	<input type="text" value="300"/>	<input type="text" value="1"/>	<input type="text" value="54531"/>	Forward <input type="text"/>	RGB <input type="text"/>	<input type="text" value="0"/>	<input type="text" value="0"/>	<input type="text" value="0"/>	100% <input type="text"/>	1.0
Differential Receiver: <input type="text" value="Standard"/>												
9)	<input type="text"/>	<input type="text" value="1"/>	<input type="text" value="0"/>	<input type="text" value="1"/>	<input type="text" value="0"/>	Forward <input type="text"/>	RGB <input type="text"/>	<input type="text" value="0"/>	<input type="text" value="0"/>	<input type="text" value="0"/>	100% <input type="text"/>	1.0
10)	<input type="text"/>	<input type="text" value="1"/>	<input type="text" value="0"/>	<input type="text" value="1"/>	<input type="text" value="0"/>	Forward <input type="text"/>	RGB <input type="text"/>	<input type="text" value="0"/>	<input type="text" value="0"/>	<input type="text" value="0"/>	100% <input type="text"/>	1.0
11)	<input type="text"/>	<input type="text" value="1"/>	<input type="text" value="0"/>	<input type="text" value="1"/>	<input type="text" value="0"/>	Forward <input type="text"/>	RGB <input type="text"/>	<input type="text" value="0"/>	<input type="text" value="0"/>	<input type="text" value="0"/>	100% <input type="text"/>	1.0
12)	<input type="text"/>	<input type="text" value="1"/>	<input type="text" value="0"/>	<input type="text" value="1"/>	<input type="text" value="0"/>	Forward <input type="text"/>	RGB <input type="text"/>	<input type="text" value="0"/>	<input type="text" value="0"/>	<input type="text" value="0"/>	100% <input type="text"/>	1.0

## Specific BeagleBone Outputs

E1.31 / ArtNet / DDP / KiNet

K8-B

Other

### K8-B

Revert

Clone String

Save

Enable K8-B:

Cape Type: K8-B

Pixel Timing: Normal (ws281x)

Press F2 to auto set the start channel on the next row.

PORT	DESCRIPTION	START CHANNEL	PIXEL COUNT	GROUP COUNT	END CHANNEL	DIRECTION	COLOR ORDER	START NULLS	END NULLS	ZIG ZAG	BRIGHTNESS	GAMMA
1)	<input type="text" value="SingingTree5"/>	<input type="text" value="46594"/>	<input type="text" value="246"/>	<input type="text" value="1"/>	<input type="text" value="47331"/>	Forward <input type="text"/>	RGB <input type="text"/>	<input type="text" value="0"/>	<input type="text" value="0"/>	<input type="text" value="0"/>	20% <input type="text"/>	1.0
	<input type="text" value="Mega Tree-2-str-1"/>	<input type="text" value="47332"/>	<input type="text" value="300"/>	<input type="text" value="1"/>	<input type="text" value="48231"/>	Forward <input type="text"/>	RGB <input type="text"/>	<input type="text" value="0"/>	<input type="text" value="0"/>	<input type="text" value="0"/>	100% <input type="text"/>	1.0
2)	<input type="text" value="Mega Tree-2-str-2"/>	<input type="text" value="48232"/>	<input type="text" value="300"/>	<input type="text" value="1"/>	<input type="text" value="49131"/>	Forward <input type="text"/>	RGB <input type="text"/>	<input type="text" value="0"/>	<input type="text" value="0"/>	<input type="text" value="0"/>	100% <input type="text"/>	1.0
3)	<input type="text" value="Mega Tree-2-str-3"/>	<input type="text" value="49132"/>	<input type="text" value="300"/>	<input type="text" value="1"/>	<input type="text" value="50031"/>	Forward <input type="text"/>	RGB <input type="text"/>	<input type="text" value="0"/>	<input type="text" value="0"/>	<input type="text" value="0"/>	100% <input type="text"/>	1.0
4)	<input type="text" value="Mega Tree-2-str-4"/>	<input type="text" value="50032"/>	<input type="text" value="300"/>	<input type="text" value="1"/>	<input type="text" value="50931"/>	Forward <input type="text"/>	RGB <input type="text"/>	<input type="text" value="0"/>	<input type="text" value="0"/>	<input type="text" value="0"/>	100% <input type="text"/>	1.0
5)	<input type="text" value="Mega Tree-2-str-5"/>	<input type="text" value="50932"/>	<input type="text" value="300"/>	<input type="text" value="1"/>	<input type="text" value="51831"/>	Forward <input type="text"/>	RGB <input type="text"/>	<input type="text" value="0"/>	<input type="text" value="0"/>	<input type="text" value="0"/>	100% <input type="text"/>	1.0
6)	<input type="text" value="Mega Tree-2-str-6"/>	<input type="text" value="51832"/>	<input type="text" value="300"/>	<input type="text" value="1"/>	<input type="text" value="52731"/>	Forward <input type="text"/>	RGB <input type="text"/>	<input type="text" value="0"/>	<input type="text" value="0"/>	<input type="text" value="0"/>	100% <input type="text"/>	1.0
7)	<input type="text" value="Mega Tree-2-str-7"/>	<input type="text" value="52732"/>	<input type="text" value="300"/>	<input type="text" value="1"/>	<input type="text" value="53631"/>	Forward <input type="text"/>	RGB <input type="text"/>	<input type="text" value="0"/>	<input type="text" value="0"/>	<input type="text" value="0"/>	100% <input type="text"/>	1.0
8)	<input type="text" value="Mega Tree-2-str-8"/>	<input type="text" value="53632"/>	<input type="text" value="300"/>	<input type="text" value="1"/>	<input type="text" value="54531"/>	Forward <input type="text"/>	RGB <input type="text"/>	<input type="text" value="0"/>	<input type="text" value="0"/>	<input type="text" value="0"/>	100% <input type="text"/>	1.0
Differential Receiver: <input type="text" value="Standard"/>												
9)	<input type="text"/>	<input type="text" value="1"/>	<input type="text" value="0"/>	<input type="text" value="1"/>	<input type="text" value="0"/>	Forward <input type="text"/>	RGB <input type="text"/>	<input type="text" value="0"/>	<input type="text" value="0"/>	<input type="text" value="0"/>	100% <input type="text"/>	1.0
10)	<input type="text"/>	<input type="text" value="1"/>	<input type="text" value="0"/>	<input type="text" value="1"/>	<input type="text" value="0"/>	Forward <input type="text"/>	RGB <input type="text"/>	<input type="text" value="0"/>	<input type="text" value="0"/>	<input type="text" value="0"/>	100% <input type="text"/>	1.0
11)	<input type="text"/>	<input type="text" value="1"/>	<input type="text" value="0"/>	<input type="text" value="1"/>	<input type="text" value="0"/>	Forward <input type="text"/>	RGB <input type="text"/>	<input type="text" value="0"/>	<input type="text" value="0"/>	<input type="text" value="0"/>	100% <input type="text"/>	1.0
12)	<input type="text"/>	<input type="text" value="1"/>	<input type="text" value="0"/>	<input type="text" value="1"/>	<input type="text" value="0"/>	Forward <input type="text"/>	RGB <input type="text"/>	<input type="text" value="0"/>	<input type="text" value="0"/>	<input type="text" value="0"/>	100% <input type="text"/>	1.0

The capes from KulpLights.com can drive 800 pixels per port at 40 fps (roughly 1600 per port at 20 fps). Some controllers (like the KulpLights.com line of controllers) can also drive other components to control additional pixels like an Expansion Board, Differential Expansion Board, Differential Receiver, or Smart Differential Receivers.



Some capes also have RJ45 ports and depending on the cape, some can be used to drive 4 channels of serial data each. If you do not send any serial data then you will have all the ports available to connect Differential Receivers. Each RJ45 port can connect to one Differential Receiver or up to 3 daisy-chained Smart Differential Receivers with a Cat5 cable up to 250 feet to the furthest Receiver. The Differential Receivers and Smart Differential Receivers each have 4 ports for pixel string connections.

At the top of the page, you have the following options:

- Enable BBB String Cape (usually the model will be shown)- This allows you to enable/disable the cape without losing your configuration settings.
- Cape Type- You will need to select the type of Cape that you are using and the type of output you are going to use. If you are using one of the Expansion Boards then select one of the options with the Expansion Board Setting. If you are going to use any of the RJ45 ports for outputting serial data, then select one of the options that corresponds to the number of serial channels you are going to output (Each RJ45 port outputs 4 serial channels). If you are not going to output any serial data from the F8, then select the (No Serial) option.
- Version- If it is a Kulplights.com F8 board, you will need to select the version of the board.
- Pixel Timing- You can select the type of pixel that you are going to use, right now only ws281x and ws1903 type pixels are supported.
- Revert- This will revert to the last saved settings.
- Clone String- If you select a string port, you can clone the data to the string ports below. Once you select a string port, click on the Clone String button and you will be asked how many copies of the string you want to clone below the selected string.
- Save- This will save your settings

Press F2 to auto set- When you complete a row of the configuration, you can press F2 and it will fill in the start channel on the next row. This is helpful if you have several ports that are running contiguous channels.

- Expansion Board- This will add 16 more ports to be connected locally.
- Differential Expansion Board- This will add the ability to add up to 4 Differential Receivers. Each Differential Receiver has 4 ports and each Differential Receiver can be located up to 250 feet from the F8 with a Cat5 cable connecting them. If you use Smart Differential Receiver boards, then you can add up to 3 Differential Receiver boards to each port of the Differential Expansion board by connecting them in a daisy chain.

Each port on all of the controllers/receivers have the following options:

- Description- You can enter a description for the pixels attached to the port.
- Start Channel- Enter the start channel that corresponds to the start channel in your sequencing software (xLights, Vixen, etc.)
- Pixel Count- Enter the number of pixels connected to that port of the hat.
- Group Count- If you have groups of pixels that are going to be illuminated exactly the same all of the time, you can put them in groups.
- End Channel- This indicates the ending channel for the string.
- Direction- Selecting reverse will reverse the data sent to the pixels so that it will act like the data is coming in from the end of the string.
- Color Order- You can select a color order to match the color order for the pixels you are using.

- Start Nulls- If you are using Null Nodes in the beginning of your string to help boost the transmission distance, then enter the number of Null Nodes you have in that section of the string.
- End Nulls- If you are using Null Nodes at the end of your string to help boost the transmission distance, then enter the number of Null Nodes you have in that section of the string.
- Zig Zag- This setting is useful for items like a Mega Tree where one string is used for more than one strand of the tree. This is more commonly set up in the sequencing software (xLights, Vixen, etc.) Enter the number of times the string changes direction. **Do not use Zig Zag if you used the Strands/String setting in your sequencing software.**
- Brightness- You can set the brightness for your pixel string. Many dense props are very bright and a lower brightness might look better. This also reduces the power required to light the pixels.
- Gamma- This is a correction factor that can be entered due to the way that our eyes perceive colors and brightness in a non-linear way. It can also be used to correct color variations on pixel strings from different vendors

## LED Panels

This tab is for configuring P10 or P5 Panels that are going to be controlled by a Hat or Cape connected to the FPP device. Due to P10 and P5 panels not having a universal standard design, there are many settings that might need to be configured to get them to work correctly. The settings available are different depending if the FPP device is on a Raspberry Pi or BeagleBone SBC.

### Pi LED Panels Screen

**LED Panels**
Save

Enable Led Panels: 
Connection: Hat/Cap/Cape
Wiring Pinout: Standard

Panel Layout:	W: <span style="border: 1px solid #ccc; padding: 2px;">1</span> H: <span style="border: 1px solid #ccc; padding: 2px;">1</span>	Start Channel:	<span style="border: 1px solid #ccc; padding: 2px;">1</span>
Single Panel Size (WxH):	<span style="border: 1px solid #ccc; padding: 2px;">32x16 1/8 Scan</span>	Channel Count:	1536(512 Pixels)
Model Start Corner:	<span style="border: 1px solid #ccc; padding: 2px;">Top Left</span>	Default Panel Color Order:	<span style="border: 1px solid #ccc; padding: 2px;">RGB</span>
Panel Gamma:	<span style="border: 1px solid #ccc; padding: 2px;">2.2</span>	GPIO Slowdown:	<span style="border: 1px solid #ccc; padding: 2px;">1 (multi-core Pi)</span>
Brightness:	<span style="border: 1px solid #ccc; padding: 2px;">100%</span>	Use CPU PWM:	<input type="checkbox"/>
Panel Interleave:	<span style="border: 1px solid #ccc; padding: 2px;">Off</span>		
Color Depth:	<span style="border: 1px solid #ccc; padding: 2px;">8 Bit</span>		

**LED Panel Layout:**

Advanced Layout?

View Config from front?

**Front View**

O-1 ▼ ➤

P-1 ▼

C-Def ▼

- O-# is physical output number.  
 - P-# is panel number on physical output.  
 - C-(color) is color order if panel has different color order than default (C-Def).  
 - Arrow ➤ indicates panel orientation, click arrow to rotate.

**Notes and hints:**

- When wiring panels, divide the panels across as many outputs as possible. Shorter chains on more outputs will have higher refresh than longer chains on fewer outputs.
- If not using all outputs, use all the outputs from 1 up to what is needed. Data is always sent on outputs up to the highest configured, even if no panels are attached.
- The FPP developers strongly encourage using either a BeagleBone based panel driver (Octoscroller, PocketScroller) or using a ColorLight controller. The Raspberry Pi panel code performs poorly compared to the other options and supports a much more limited set of options.



# BB LED Panels Screen

## LED Panels

Enable Led Panels:  Connection: Hat/Cap/Cape Wiring Pinout: PocketScroller

Panel Layout: W: 3 H: 3 Start Channel: 16336

Single Panel Size (WxH): 32x16 1/8 Scan Channel Count: 13824(4608 Pixels)

Model Start Corner: Top Left Default Panel Color Order: RBG

Panel Gamma: 2.2

Brightness: 5 Output By Row:

Panel Interleave: Off

Color Depth: 12 Bit

LED Panel Layout:  
Advanced Layout?   
View Config from front?

Front View		
O-1	O-1	O-1
P-3	P-2	P-1
C-Def	C-Def	C-Def
O-2	O-2	O-2
P-3	P-2	P-1
C-Def	C-Def	C-Def
O-3	O-3	O-3
P-3	P-2	P-1
C-Def	C-Def	C-Def

- O-# is physical output number.  
- P-# is panel number on physical output.  
- C-(color) is color order if panel has different color order than default (C-Def).  
- Arrow indicates panel orientation, click arrow to rotate.

**Notes and hints:**

- When wiring panels, divide the panels across as many outputs as possible. Shorter chains on more outputs will have higher refresh than longer chains on fewer outputs.
- If not using all outputs, use all the outputs from 1 up to what is needed. Data is always sent on outputs up to the highest configured, even if no panels are attached.

- Enable LED Panels- If you are using LED panels, this needs to be checked. You can disable the panels without losing your configuration
- Connection- This is to identify the type of LED Panel controller you are using and will usually auto-populate to the correct connection type, the options are Hat/Cap/Cape. Colorlight, or Linsn.
- Wiring Pinout- This setting is to identify which SBC the LED panel controller is being used. It will normally auto-populate with the correct selection if it can be detected.
- Panel Layout (WxH)- enter the number of panels you are using in Width by Height.
- Single Panel Size (WxH)- Enter the size in pixels of each individual panel and the scan rate. (P10 panels are 32x16 and P5 panels are 64x32)\*
- Model Start Corner- This should typically be upper left if you are using xLights and bottom left if you are using Vixen. For other Sequencing software, you should match the setting in that software.
- Panel Gamma- You can apply a Gamma correction to help correct the way our eyes process colors in dim situations.
- Brightness- You can adjust the overall brightness with this setting.
- Panel Interleave- some outdoor panels (possibly others) use a non-standard transmission of the data. If they do, then this setting will need to be modified to match the transmission method of your panels. This setting is not available on the Raspberry Pi devices.
- Color Depth- Is used to set the number of possible colors. The color depth can be reduced to minimize flicker on larger sets of panels if needed.
- Start Channel- This is the start channel for your LED Panel and is usually the Absolute address identified in your sequencing software.
- Channel Count- This is the total number of channels that your panel array will require.

- Default Panel Color Order- Panels can have a different color order. You can set the color order for your panel with this option.
- GPIO Slowdown- Some panels have a slower refresh rate than the standard ones and might show some ghosting; this can be remedied by adding some slowdown to the refresh rate that is being sent to the panels. This setting is not available on the BeagleBone devices.
- Output by Row- Some panels will output the data by rows instead of sequentially, if that is the case, you can select this option. This setting is not available on the Raspberry Pi devices.
- Use CPU PWM- This is used for some of the Adafruit or other controllers that use CPU PWM to drive the panels.

Save- this will save your configuration.

\*- Some 1/4 scan and 1/2 scan panels use a non-conventional addressing mode and you might have to use one of the A, AB or ABCD addressing mode panel types. There usually is no indication on the panels so it might be trial and error to select the correct one. These options are only available on the BeagleBone systems.

## LED Panel Layout

Panels can be configured in several ways and it is important that the configuration matches the actual assembly/connection of your panels. The panels should be connected to as many outputs as possible so that you have a higher refresh rate. For example, if you have 4 panels it is better to connect 1 panel each to 4 different ports than daisy-chaining all 4 panels off a single port. Each panel has to be identified how it is connected to the controller and the order that the panels are connected together. This is configured by setting the Output Number and Panel Order numbers in the Layout screen. The FPP device needs to know the exact way that you assembled your LED panels together and the way they are connected to both the controller and each other. There are 2 views in order to configure your LED Panel layout.

## Standard LED Panel Layout

**LED Panels**
Save

---

Enable Led Panels:

Connection: Hat/Cap/Cape

Wiring Pinout: PocketScroller

Panel Layout: W: 3 H: 3

Single Panel Size (WxH): 32x16 1/8 Scan

Model Start Corner: Top Left

Panel Gamma: 2.2

Brightness: 5

Panel Interleave: Off

Color Depth: 12 Bit

LED Panel Layout:  
Advanced Layout?

View Config from front?

Front View

O-1	O-1	O-1
P-3	P-2	P-1
C-Def	C-Def	C-Def
O-2	O-2	O-2
P-3	P-2	P-1
C-Def	C-Def	C-Def
O-3	O-3	O-3
P-3	P-2	P-1
C-Def	C-Def	C-Def

- O-# is physical output number.  
 - P-# is panel number on physical output.  
 - C-(color) is color order if panel has different color order than default (C-Def).  
 - Arrow indicates panel orientation, click arrow to rotate.

Start Channel: 16336

Channel Count: 13824(4608 Pixels)

Default Panel Color Order: RGB

Output By Row:

**Notes and hints:**

- When wiring panels, divide the panels across as many outputs as possible. Shorter chains on more outputs will have higher refresh than longer chains on fewer outputs.
- If not using all outputs, use all the outputs from 1 up to what is needed. Data is always sent on outputs up to the highest configured, even if no panels are attached.

Make sure that you are referencing the panels correctly. You can configure the panels as if you are looking at the panels from the front or from the rear, more commonly referred to as a “wiring view.” To change the view, toggle the “View Config from front” checkbox. Make sure you save any changes made before you change the view.

The panel arrows can go in any direction you like to make wiring easier when you assemble the panels but they have to match in FPP. To change the arrow orientation, click on the arrow in the corresponding LED panel and it will rotate each time you click it.

The Output Number is the Setting that looks like O-1, O-2, etc. A panel is considered to be connected to an output if the data ribbon is wired directly to the controller or the data ribbon is wired to another panel that is connected to that port.

The Panel Order number is the Setting that looks like P-1, P-2, etc. This is the order that panels are connected to a particular port. The first panel connected to a port would be P-1, the next panel in the chain would be P-2, etc.

The Color Order is the setting that looks like C-Def. This is the color order of the RGB pixels and it is common for them to be in different orders depending on the manufacturer. If the colors are not displaying correctly, then you can change the order here or in xLights (**don't change it in both.**)

## Advanced Layout View

You can change the layout to the advanced view by selecting the Advanced Layout button. This view is for more complex layouts. You can define panels in any orientation, the panels don't have to be in the same orientation and they can be separated and the effects will display correctly. You can only use the front view in the Advanced layout.

You will get a screen similar to this:

**LED Panel Layout:**  
Advanced Layout?

Front View

▲ O-1 P-3 @ 0,0	▲ O-1 P-2 @ 32,0	▲ O-1 P-1 @ 64,0
▲ O-2 P-3 @ 0,16	▲ O-2 P-2 @ 32,16	▲ O-2 P-1 @ 64,16
▲ O-3 P-3 @ 0,32	▲ O-3 P-2 @ 32,32	▲ O-3 P-1 @ 64,32

**Selected Panel:**  
Output: 3 ▾  
Panel: 1 ▾  
Color: Def ▾  
X Pos: 64  
Y Pos: 32  
Rotate

**UI Layout Size:** Pixels Wide: 128    Pixels High: 64

The Advanced Layout has the following sections/features:

**Matrix Size-** This is in the upper left section of the top window, this indicates the minimum matrix size that is needed to represent the matrix configuration you have configured.

**Channel Count-** This will indicate the number of channels needed to represent your matrix. These numbers will change based on the configuration but are not used for the configuration in your sequencing software and don't impact network traffic.

**Advanced Layout Configuration screen-** If you have assembled your panels in a "non-standard" configuration, then you can mimic your configuration in this panel so that it will display properly. You can drag the individual panels to the position you need and by using the Selected Panel section you can configure the Output Port, the Panel Order, the Color order and rotate the panel so that the arrows are aligned correctly. For easy identification, the panels are color coded based on the Output Port connection.

**UI Layout Size-** This will configure the "window" (the grey box) that you have to move the panels around.

An example of how to use this would be that you have a 6x2 P10 panel and have 3 windows that are side by side but the windows have a gap between them and you are going to put 4 panels in each window. If you configure it in the "normal" way then scrolling items will not look correct because the scrolling items will be "pushed together" at the gap instead of a pause/space where the scrolling item should have. This is how that configuration might look:

**LED Panel Layout:**

Advanced Layout?

Front View

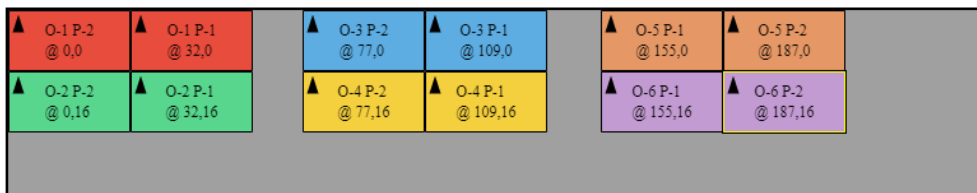

**Selected Panel:**

Output:    
 Panel:    
 Color:    
 X Pos: 187   
 Y Pos: 16

**UI Layout Size:** Pixels Wide:  Pixels High:

## Other

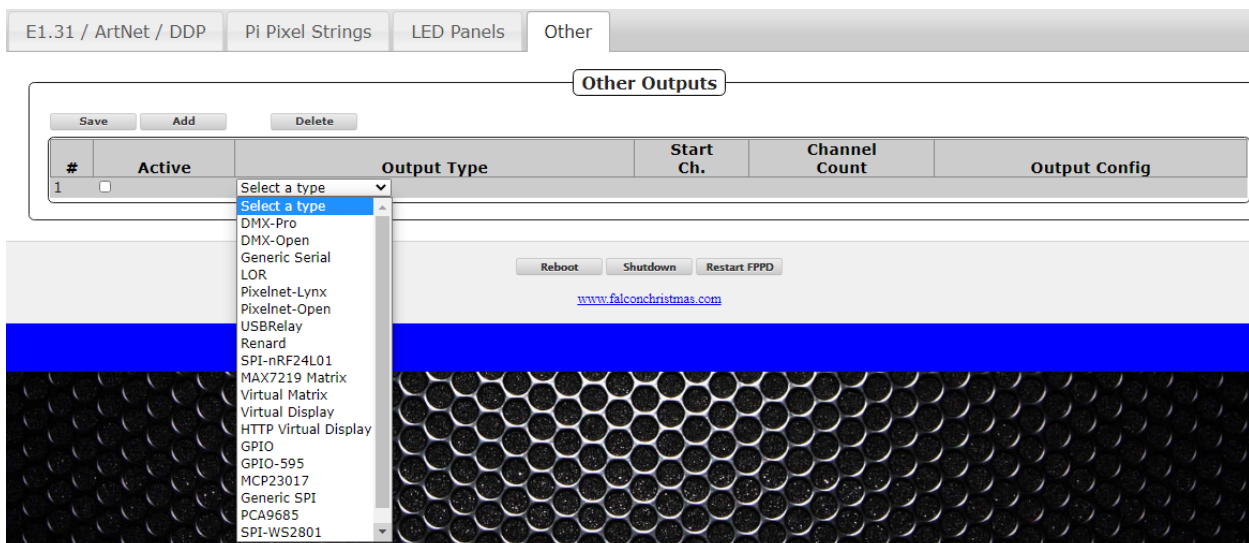

The other Output tab is to define other less common output types. This is the location that you would configure a Virtual Matrix.

If you are using a Pi Cap and need to send out DMX data, then the Output type would be DMX-Open and the Output Config Port will be ttyAMA0.

## Output Processors

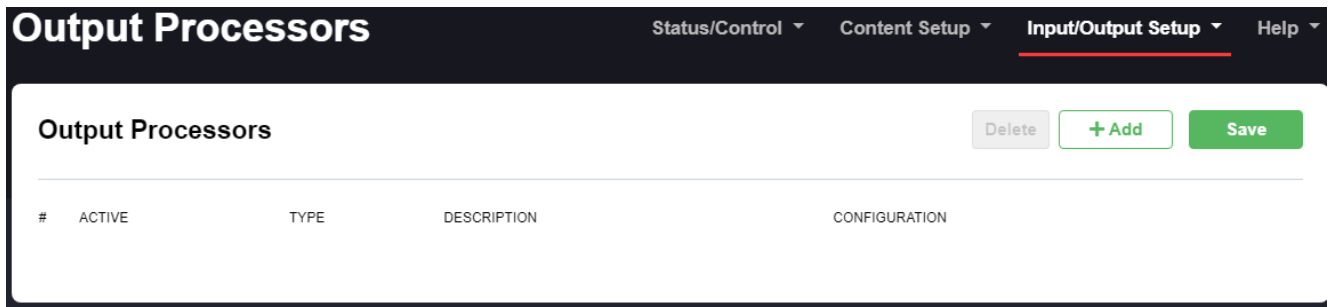

The output processors page is utilized to modify the outgoing data. This can be useful for several things such as moving a prop after the .fseq file has been saved to the FPP, or adjusting the brightness if your controller does not support dimming.

The Output Processors are:

- Remap-

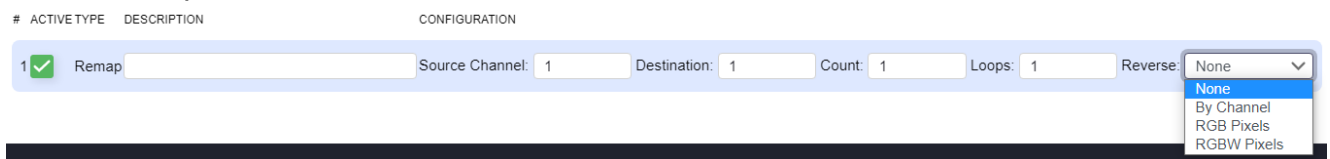

The remap processor is beneficial for several things such as when a prop has been moved because a port on the controller isn't working or you have to replace a "dumb" string with a pixel string.

- Description-This can be used to identify the reason for the remapping for future reference.
- Source Channel- Enter the first channel you want to remap to another location.
- Destination- Enter the first channel that you want the data remapped to.
- Count- Enter the total number of channels that you want remapped.
- Loops- Enter the number of times that you want this remapping to occur, this can be helpful if you need to replace a dumb string with a pixel string. Enter the Source Channel and the Destination Channel and enter 3 for the Count. Then enter the number of pixels that are in the replacement string in the Loops box.
- Reverse- This can be useful if you wired a prop in reverse or changed a controller connection to the opposite end of a string. The reverse can be by channel or by pixel type.

- Brightness-



You can modify the brightness or Gamma correction on a range of channels. This can be useful if your controller doesn't support the brightness/gamma correction or if you can't reach your controller via the web interface.

- **Hold Value-**

#	ACTIVE	TYPE	DESCRIPTION	CONFIGURATION
1	<input checked="" type="checkbox"/>	Hold Value	<input type="text"/>	Start Channel: <input type="text" value="1"/> Channel Count: <input type="text" value="1"/>

If a channel value in the fseq/e1.31 is 0, instead of outputting 0, it will use the last non zero value.

This is mostly useful for servos or moving heads or similar where you don't want them going back to a "0" point in areas of the sequences that aren't sequences or between sequences.

- **Set Value-**

#	ACTIVE	TYPE	DESCRIPTION	CONFIGURATION
1	<input checked="" type="checkbox"/>	Set Value	<input type="text"/>	Start Channel: <input type="text" value="1"/> Channel Count: <input type="text" value="1"/> Value: <input type="text" value="255"/>

You can set a fixed value for a range of channels.

- **Reorder Colors-**

#	ACTIVE	TYPE	DESCRIPTION	CONFIGURATION
1	<input checked="" type="checkbox"/>	Reorder Colors	<input type="text"/>	Start Channel: <input type="text" value="1"/> Nodes: <input type="text" value="1"/> Color Order: <input type="text" value="132"/>

You can change the color order. This is helpful if you have to replace a string or part of a string and it has a different color order than the section replaced.

- **Three to Four-** FPP can convert 3-channel RGB sequence data to 4-channel RGBW pixel data. This is useful when all your sequencing is done in 3-channel RGB but you have some strings that are 4-channel RGBW

## Pixel Overlay Models

The Pixel Overlay Models feature of the Falcon Player allows the user to manually manipulate a particular model in real-time via Plugins or scripts before it is sent out to the controllers based on each model. This can be done while the rest of your display and channels are playing sequenced data. Pixel Overlay Models are typically used for Matrices or Mega Trees (or other dense props) but can be used for any model that you want to take manual control. It can also be useful if you want to individually test models through FPP.

## Pixel Overlay Models

Delete +Add Save

Create Overlays Automatically From Outputs:

MODEL NAME	START CH.	CH. COUNT	CH./NODE	ORIENTATION	START CORNER	STRINGS	STRANDS	RUNNING EFFECT
Arches_01	7921	150	3	Horizontal	Bottom Right	1	1	
Arches_02	7771	150	3	Horizontal	Bottom Right	1	1	
Arches_03	7621	150	3	Horizontal	Bottom Right	1	1	
Arches_04	7471	150	3	Horizontal	Bottom Right	1	1	
Entry_Way	13909	261	3	Horizontal	Bottom Left	3	1	
Garage-Left	13201	312	3	Horizontal	Bottom Left	3	1	
Garage-Right	13513	396	3	Horizontal	Bottom Left	3	1	
Mega_Tree	1	7200	3	Vertical	Bottom Left	8	4	

### Auto Created Pixel Overlay Models

MODEL NAME	START CH.	CH. COUNT	CH./NODE	ORIENTATION	START CORNER	STRINGS	STRANDS	RUNNING EFFECT
Mega Tree-2	47332	7200	3	Horizontal	Bottom Left	8	1	
SingingTree5	46594	738	3	Horizontal	Bottom Left	1	1	

The Pixel Overlay Model has to match the settings configured in your sequencing software and string ports in your controller.

If you select the Option to Create Overlays Automatically from Outputs, the FPP will create the Pixel Model Overlays for you based on your configured output, you can also export them from xLights to your FPP using FPP Connect and selecting the Models option but you will get Pixel Overlay Models for all models in your show which is typically not what you want.

If you want to manually enter the Pixel Overlay Models, these are the settings:

**Model Name-** This is a name to use to reference the Pixel Overlay Model in other areas of FPP such as Plugins, Scripts, etc.

**Start Ch.-** The Start Channel needs to match the start channel in your sequencing software and your String Ports.

**Ch. Count-** This is the number of channels (not pixels) that this model is using.

**CH./Node-** This is how many channels each node needs to control it. This is typically 3.

**Orientation-** This will be the orientation that you configured the matrix in your sequencing software.

**Start Corner-** This will normally be Top Left if you are using xLights and Bottom Left if you are using Vixen for P10/P5 type panels. For other items like Pixel Matrices or Mega Trees, this will be the settings that you used in your sequencing software.

**Strings-** This will typically be the number of rows in your matrix for P10/P5 type panels. For other items like Pixel Matrices or Mega Trees, this will be the settings that you used in your sequencing software.

**Strands-** This will be 1 for P10/ P5 type panels. For other items like Pixel Matrices or Mega Trees, this will be the settings that you used in your sequencing software.

This can be used for examples such as the following:

- Displaying real-time dynamic text on a matrix or Mega Tree
- Displaying the current time or a Christmas countdown timer on a matrix



- Turning on/off individual channels for items such as a Tune-To sign, or inflatables without having to sequence the channels for these items in every one of your sequence files.

[The Matrix Tools plugin](#) available via the Plugin Manager Page uses the Pixel Overlay feature to allow display and scrolling of dynamic text on a Pixel Overlay Model using a web interface. As an example of the power and flexibility of the Real-Time Pixel Overlay feature, you can also use the Matrix Tools plugin to draw in Real-Time on your matrix using your mouse and web browser.

## GPIO Inputs

EN	HDR-PIN	GPIO# - GPIO	PULL UP/DOWN	DESCRIPTION	COMMANDS: RISING EDGE	COMMANDS: FALLING EDGE
<input type="checkbox"/>	P8-03	38 - 1/6	None/External		Command: <input type="text"/>	Command: <input type="text"/>
<input checked="" type="checkbox"/>	P8-04	39 - 1/7	Pull Down		Command: Trigger Command Preset Slot Multicast: <input type="text"/> Preset Slot: 5	Command: <input type="text"/>
<input type="checkbox"/>	P8-05	34 - 1/2	None/External		Command: <input type="text"/>	Command: <input type="text"/>
<input type="checkbox"/>	P8-06	35 - 1/3	None/External		Command: <input type="text"/>	Command: <input type="text"/>
<input type="checkbox"/>	P8-07	66 - 2/2	None/External		Command: <input type="text"/>	Command: <input type="text"/>
<input type="checkbox"/>	P8-08	67 - 2/3	None/External		Command: <input type="text"/>	Command: <input type="text"/>
<input type="checkbox"/>	P8-09	69 - 2/5	None/External		Command: <input type="text"/>	Command: <input type="text"/>
<input type="checkbox"/>	P8-10	68 - 2/4	None/External		Command: <input type="text"/>	Command: <input type="text"/>
<input type="checkbox"/>	P8-11	45 - 1/13	None/External		Command: <input type="text"/>	Command: <input type="text"/>
<input type="checkbox"/>	P8-12	44 - 1/12	None/External		Command: <input type="text"/>	Command: <input type="text"/>
<input type="checkbox"/>	P8-13	23 - 0/23	None/External		Command: <input type="text"/>	Command: <input type="text"/>
<input type="checkbox"/>	P8-14	26 - 0/26	None/External		Command: <input type="text"/>	Command: <input type="text"/>

GPIO Inputs allow the triggering of internal FPP Events via external input. Each GPIO Input is connected to a pin on the FPP's GPIO header or attached to an add-on I/O board such as the PiFace. GPIO Inputs allow two events to be attached to each pin, one rising event and one falling event. In FPP, you can set the GPIO resting state to either high (pull up) or low (pull down) using the internal resistors or you can set the resting state using external pull up or pull down resistors. If you select the None/External option, make sure your circuitry connected to the pin establishes either a high or low state or else the pin will be floating which can cause false triggers. See the [GPIO Inputs](#) section for more detailed wiring information.

- En- If you are going to use the GPIO input function, then the pin you are using needs to be enabled by placing a check in this box.
- Hdr-Pin- This is for reference to locate the pin on the headers
- GPIO#- This is the Pin Label as identified by the manufacturer and for reference only.
- Pull up/Down- You can set the internal pull up or pull down resistor in this box.
- Description- You can add a description of what you are using this input trigger for.
- Commands- In this section, you can select a previously saved event for the rising and or falling events. Refer to the [Command Presets](#) section for more details.

Input triggers can be useful for various things such as a button to start or stop a sequence, a motion sensor to activate a sequence or another external device just to name a few.



# Help

This section is for information on troubleshooting, references and updates.

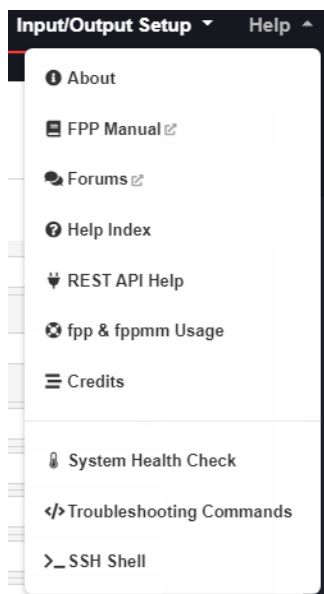

## About

The About page provides information about the current FPP version and statistics relevant to the running FPP. This is also the page that you will navigate to in order to perform a manual update.

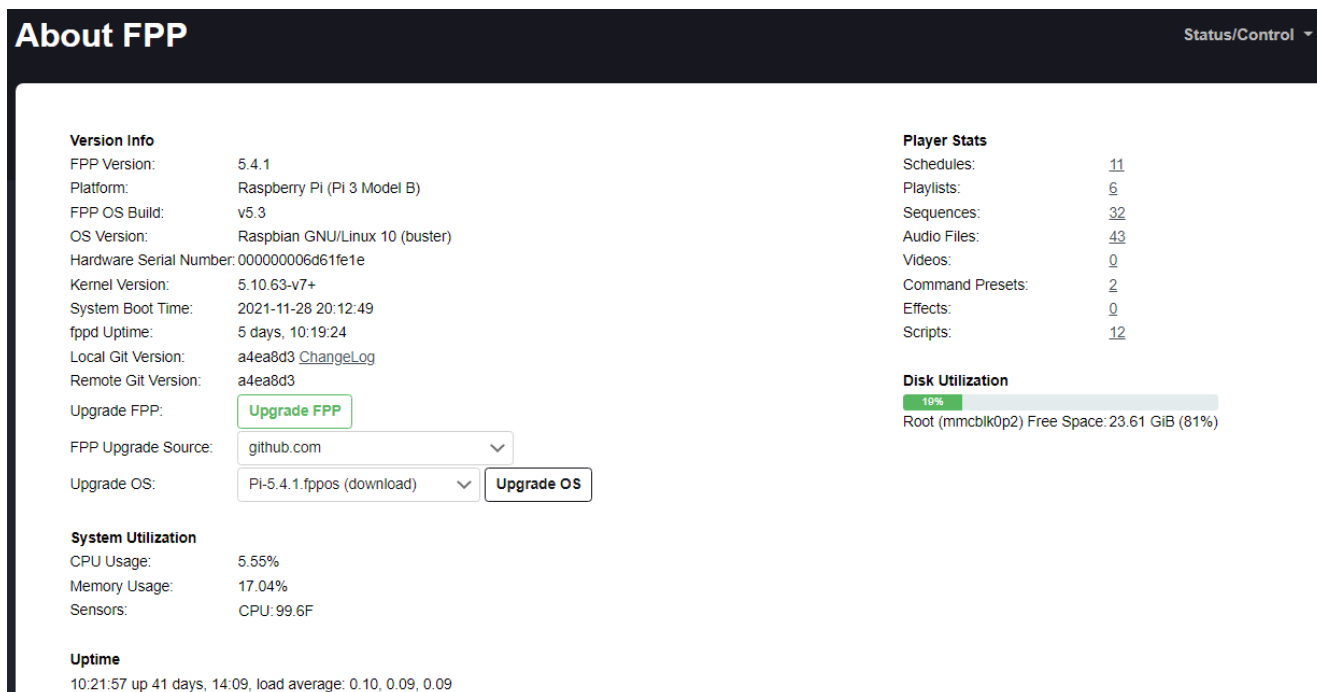
A screenshot of the 'About FPP' page. The page has a dark header with 'About FPP' on the left and 'Status/Control' on the right. The main content is divided into several sections: 'Version Info' (FPP Version: 5.4.1, Platform: Raspberry Pi (Pi 3 Model B), FPP OS Build: v5.3, OS Version: Raspbian GNU/Linux 10 (buster), Hardware Serial Number: 00000006d61fe1e, Kernel Version: 5.10.63-v7+, System Boot Time: 2021-11-28 20:12:49, fppd Uptime: 5 days, 10:19:24, Local Git Version: a4ea8d3, Remote Git Version: a4ea8d3, Upgrade FPP: Upgrade FPP, FPP Upgrade Source: github.com, Upgrade OS: Pi-5.4.1.fppos (download) Upgrade OS), 'Player Stats' (Schedules: 11, Playlists: 6, Sequences: 32, Audio Files: 43, Videos: 0, Command Presets: 2, Effects: 0, Scripts: 12), 'Disk Utilization' (19% bar chart, Root (mmcblk0p2) Free Space: 23.61 GiB (81%)), 'System Utilization' (CPU Usage: 5.55%, Memory Usage: 17.04%, Sensors: CPU: 99.6F), and 'Uptime' (10:21:57 up 41 days, 14:09, load average: 0.10, 0.09, 0.09).

This page has information that can be useful for troubleshooting or updating your FPP system.

## Version Info

- FPP Version- This is your current FPP Version.
- Platform- This will identify the SBC platform of this FPP device.
- FPP OS Build- This is the current operating system build.
- OS Version- This lists the SBC base operating system version. It is possible to have the FPP build to be on a version higher than the operating system. There are some functions/capabilities that will not work unless the OS has been upgraded.
- Hardware Serial Number- This will list the serial number for this FPP device.
- Kernel Version- This lists the Kernel Version.
- System Boot Time- This will show the date and time that this FPP was booted up.
- fppd Uptime- This will show how long fppd has been running (restarting fppd will reset this)
- Local Git Version- This lists the current Git version that is installed. The ChangeLog link will show a summary of changes that have occurred since the initial release. If there is an update available, it will indicate that next to the version.
- Remote Git Version- This lists the most current Git version available. If this shows “Unknown” then your FPP does not have access to the internet. Possibly due to network configuration errors. If there is an update available, then a Preview Changes link will be available so you can view what changes the update will provide.

## Upgrade FPP

If there is an update available to the minor version of FPP, FPP will indicate this on the Local Git Version and you can manually update the software by clicking the Upgrade FPP button. If there is a Major version upgrade, you will need to upgrade the OS and if your FPP has connection to the internet then you can download the fppos file directly by selecting it in the Upgrade OS dropdown. There are several options for updating your FPP device. You can upgrade from different sources based on the option selected in the FPP Upgrade Source. The FPP Upgrade source will be used for any upgrades on this device including any upgrades generated from the MultiSync page.

Local Git Version:	592c277 <a href="#">ChangeLog</a> (Update is available)
Remote Git Version:	ca58ca9 <a href="#">Preview Changes</a>
Upgrade FPP:	<input type="button" value="Upgrade FPP"/>
FPP Upgrade Source:	<input type="text" value="github.com"/> ▾
Upgrade OS:	<input type="text" value="BBB-5.3.fppos"/> ▾ <input type="button" value="Upgrade OS"/>

### Upgrade from GitHub

You can select GitHub to upgrade directly if your FPP device has a connection to the internet. This will only update this device to the most current version for the branch level that is installed on this device. If you need to upgrade to a newer branch and/or upgrade the OS version, you will have to upgrade through a Re-image or FPPOS upgrade.

## Upgrade from another FPP

If this FPP doesn't have an internet connection but does have local access to another FPP with a newer version, you can set the upgrade source to the other FPP Device.

Upgrade FPP: [Upgrade FPP](#)

FPP Upgrade Source: 192.168.1.100 - FPPMaster

Upgrade OS: github.com

**System Utilization**

CPU Usage: 23.15%

Memory Usage: 23.15%

192.168.1.100 - FPPMaster

192.168.1.101 - YardPi

192.168.1.104 - FPP-PocketScroller

192.168.1.250 - FPP-Pi4Test

192.168.101.1 - YardPi

This will upgrade this fpp device to match the current version of the device selected in the Upgrade Source. It won't upgrade the OS version, just the FPP version. If you need to upgrade to a newer OS version, you will have to upgrade through a Re-image or FPP OS upgrade.

## Upgrade from FPP OS

FPP has an "in place" upgrade method that can upgrade the FPP version AND OS without reimaging the SD card. You have to download the appropriate fpos file from GitHub and then upload it to your FPP device. Make sure you select the correct version for the SBC you are using.

You will then get the option to upgrade the OS.

### Version Info

FPP Version: 5.x-master-384-ge5cc9940

Platform: BeagleBone Black

FPP OS Build: v5.0-alpha

OS Version: Debian GNU/Linux 10 (buster)

Hardware Serial Number: 2034SBB06537

Kernel Version: 5.4.106fpp

System Boot Time: 2021-07-26 15:35:33

fppd Uptime: 01:40:06

Local Git Version: e5cc994 [ChangeLog](#) (Update is available)

Remote Git Version: 3a08e0f [Preview Changes](#)

Upgrade FPP: [Upgrade FPP](#)

FPP Upgrade Source: github.com

Upgrade OS: BBB-5.0-alpha1.fpos [Upgrade OS](#)

If you use the fpos upgrade, you may want to delete the fpos file after you are done because they are very large and take up a lot of space on your uSD card.

Note: Depending on the Upgrade, the fpos could take quite a bit of time and FPP will seem like it isn't upgrading but this process shouldn't take more than 30 minutes.

## System Utilization

This will show your system stats and performance

### System Utilization

CPU Usage: 13.35%  
Memory Usage: 23.19%

### Uptime

09:35:09 up 17:59, load average: 0.81, 0.92, 0.91

- CPU Usage- This will show the utilization of the CPU at the time the page loads, it does not update until the page is refreshed.
- Memory Usage- This will show how much of the RAM is being used at the time the page loads, it does not update until the page is refreshed.
- Uptime- This shows the current system time and how long the FPP has been running. It will also list the load averages for that device in the last minute, 5 minutes and 15 minutes respectively..

## Player Stats

This shows an overview of the files saved on your system. If you click on the number next to the item, it will take you to the appropriate page where these are stored.

### Player Stats

Schedules:	<a href="#">7</a>
Playlists:	<a href="#">6</a>
Sequences:	<a href="#">36</a>
Audio Files:	<a href="#">36</a>
Videos:	<a href="#">0</a>
Command Presets:	<a href="#">1</a>
Effects:	<a href="#">0</a>
Scripts:	<a href="#">9</a>

## Disk Utilization

This shows the free space on your storage devices.

### Disk Utilization

15%   
Root (mmcblk0p2) Free Space: 24.75 GiB (85%)

# FPP Manual

This will show the most current FPP Manual if your FPP Device has internet access. If your FPP device does not have an internet connection, you can access this manual at:

[https://falconchristmas.github.io/FPP\\_Manual\(5.4\).pdf](https://falconchristmas.github.io/FPP_Manual(5.4).pdf)

## Forums

This will link you to the Falcon Christmas forum which is a great resource for getting help.

## Help Index

The Help Index has links to various topics and information regarding those topics as a quick reference. The user manual has more detailed information on these subjects.

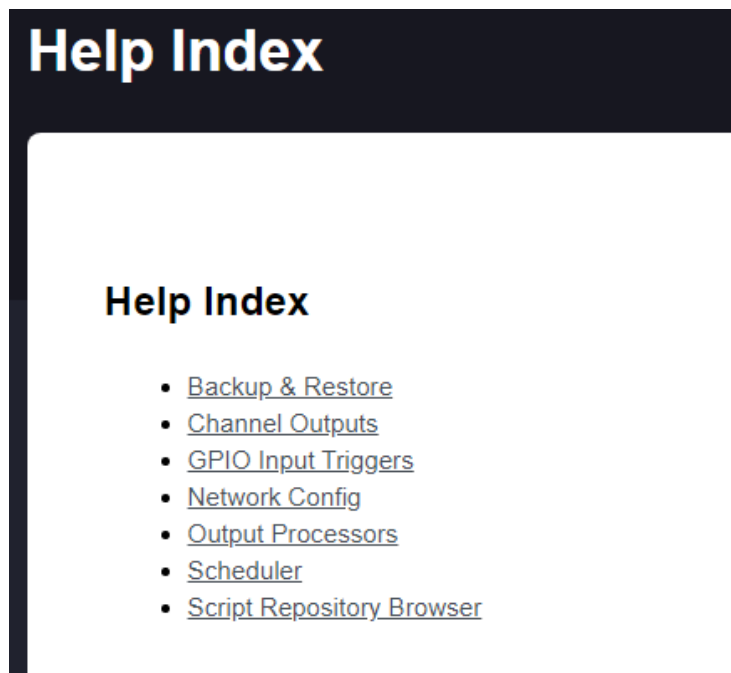

# REST API Help

This section is useful for people that are developing Plugins or other software enhancements and provides a list of endpoints and a test function to reveal the output for your device for reference.

API Help
Status/Control ▾ Content Setup ▾ Input/Output Setu

### FPP API Endpoints

**NOTE: FPPD endpoints are indicated by "" and require FPPD to be running or a timeout error will occur**

- [channel/input/stats](#)
- [channel/output/file](#)
- [channel/output/processors](#)
- [command/CommandName\(/Args\)](#)
- [commands](#)
- [configfile\(/SubDir\)](#)
- [configfile\(/SubDir/FileName\)](#)
- [email/configure](#)
- [email/test](#)
- [file/DirName/FileName](#)
- [file/DirName/copy/source/dest](#)
- [file/DirName/rename/source/dest](#)
- [file/move/FileName](#)
- [files/DirName](#)
- [files/zip/DirName](#)
- [fppd/e131stats](#)
- [fppd/effects](#)
- [fppd/log](#)
- [fppd/multiSyncStats](#)
- [fppd/multiSyncSystems](#)
- [fppd/schedule](#)
- [fppd/status](#)
- [fppd/testing](#)
- [fppd/version](#)
- [fppd/volume](#)
- [git/originLog](#)
- [git/reset](#)
- [git/status](#)
- [help](#)
- [media](#)
- [media/MediaName/duration](#)
- [media/MediaName/meta](#)
- [models](#)
- [models/ModelName](#)
- [network/dns](#)
- [network/interface](#)
- [network/interface/interfaceName](#)
- [network/interface/interfaceName/apply](#)
- [network/presistentNames](#)
- [network/wifi\\_strength](#)
- [network/wifi\\_strength/interface](#)
- [network/wifi\\_strength/interface](#)
- [overlays/fonts](#)
- [overlays/model/ModelName](#)
- [overlays/model/ModelName/clear](#)
- [overlays/model/ModelName/data](#)
- [overlays/model/ModelName/datafile](#)
- [overlays/model/ModelName/fill](#)
- [overlays/model/ModelName/pixel](#)
- [overlays/model/ModelName/state](#)
- [overlays/model/ModelName/text](#)
- [overlays/models](#)
- [playlist/PlaylistName](#)
- [playlist/PlaylistName/SectionName/item](#)
- [playlist/PlaylistName/start](#)
- [playlists](#)
- [playlists/pause](#)
- [playlists/playable](#)
- [playlists/resume](#)
- [playlists/stop](#)
- [playlists/stopgracefully](#)
- [playlists/stopgracefullyafterloop](#)
- [playlists/validate](#)
- [plugin](#)
- [plugin/PluginRepoName](#)
- [plugin/PluginRepoName/updates](#)
- [plugin/PluginRepoName/upgrade](#)
- [plugin/RepoName/settings/SettingName](#)
- [proxy/IP:PATH](#)
- [scripts](#)
- [scripts/scriptName](#)
- [scripts/scriptName/run](#)
- [scripts/installRemote/category/filename](#)
- [scripts/viewRemote/category/filename](#)
- [sequence](#)
- [sequence/SequenceName](#)
- [sequence/SequenceName/meta](#)
- [sequence/SequenceName/start/startSecond](#)
- [sequence/current/step](#)
- [sequence/current/stepBack](#)
- [sequence/current/stop](#)
- [sequence/current/togglePause](#)
- [settings](#)
- [settings/SettingName](#)
- [settings/SettingName/options](#)
- [statistics/usage](#)
- [system/fppd/restart](#)
- [system/fppd/start](#)
- [system/fppd/stop](#)
- [system/reboot](#)
- [system/shutdown](#)
- [system/status](#)
- [system/volume](#)
- [testmode](#)

Clicking on any of the endpoints will take you to the relevant section for that particular Endpoint where you can run the endpoint to see the results for your system and in some cases test an endpoint with your arguments.

/api/configfile(/SubDir)/FileName	GET	Get contents of config file /home/fpp/media/config(/SubDir)/FileName	<b>Output:</b> (Raw config file contents)
	POST	Upload contents of config file /home/fpp/media/config(/SubDir)/FileName	<b>Input:</b> (Raw config file contents) <b>Output:</b> { "Status": "OK", "Message": "" }
	DELETE	Delete config file /home/fpp/media/config(/SubDir)/FileName	<b>Output:</b> { "Status": "OK", "Message": "" }
	<input type="button" value="Test"/>		
/api/email/configure	POST	Configure outbound email using existing settings	<b>Output:</b> { "Status": "OK", "Message": "" }
	<input type="button" value="Test"/>		
/api/email/test	POST	Send test email using existing settings	<b>Output:</b> { "Status": "OK", "Message": "" }
	<input type="button" value="Test"/>		

# fpp & fppmm Usage

This page provides information on some of the fpp and fppmm commands that can be used in the shell or in scripts.

## CLI Commands

### fpp -h

Usage: /opt/fpp/src/fpp [OPTION...]

fpp is the Falcon Player CLI helper utility. It can be used to query certain information and send commands to a running fppd daemon.

#### Options:

- V - Print version information
- s - Get fppd status
- v VOLUME - Set volume to 'VOLUME'
- p PLAYLISTNAME [STARTITEM] - Play Playlist PLAYLISTNAME in repeat mode
- P PLAYLISTNAME [STARTITEM] - Play Playlist PLAYLISTNAME once, optionally starting on item STARTITEM in the playlist
- c PLAYLIST\_ACTION - Perform a playlist action. Actions include:
  - next - skip to next item in the playlist
  - prev - jump back to previous item
  - stop - stop the playlist immediately
  - graceful - stop the playlist gracefully
  - pause - pause a sequence (not media)
  - step - single-step a paused sequence
  - stepback - step a paused sequence backwards
- S - Stop Playlist gracefully
- L - Stop Playlist gracefully after current loop
- d - Stop Playlist immediately
- q - Shutdown fppd daemon
- r - Restart fppd daemon
- R - Reload schedule config file
- e EFFECTNAME[,CH[,LOOP]] - Start Effect EFFECTNAME with optional start channel set to CH and optional looping if LOOP is set to 1
- E EFFECTNAME - Stop Effect EFFECTNAME



## fppmm -h

Usage: /opt/fpp/src/fppmm [OPTIONS]

### Options:

- V - Print version information
- c CHANNEL -s VALUE - Set channel number CHANNEL to VALUE  
VALUE of -1 will delete the range
- m MODEL - List info about Pixel Overlay MODEL
- m MODEL -o MODE - Set Pixel Overlay mode, Mode is one of:  
off, on, transparent, transparentrgb
- m MODEL -f FILENAME - Copy raw FILENAME data to MODEL
- m MODEL -s VALUE - Fill MODEL with VALUE for all channels
- h - This help output

## Credits

The Credits page gives credit to the major developers and contributors to the FPP software.

## Credits

### FPP Developers:

Chris Pinkham (CaptainMurdoch)  
Dan Kulp (dkulp)  
Greg Hormann (ghormann)  
Andrew Ayton (drew8n) - UI  
Adam Coulombe (wzadz1) - UI  
Justin J. Novack (jnovack) - UI  
Pat Delaney (patdelaney) - QA  
Rick Harris (Poporacer) - Manual/QA  
Mark Amber (pixelpuppy) - Manual/QA

For a full list of code contributors, visit the [contributors page](#) on github.

### FPP Created by:

David Pitts  
Tony Mace (MyKroFt)  
Mathew Mrosko (Materdaddy)  
Chris Pinkham (CaptainMurdoch)

### 3rd Party Libraries used by FPP for some Channel Outputs:

[rpi\\_ws281x](#) by Jeremy Garff  
[rpi-rgb-led-matrix](#) by Henner Zeller  
[spixels](#) by Henner Zeller  
[RF24](#) (nRF24L01)

Copyright © 2013-2021

# System Health Check

This will run some basic tests to check your system's health.

## FPP Health Check

Restart Health Check

FPPD is running  
Scheduler is enabled  
HostName is unique  
Gateway Check  
Default Gateway (192.168.1.1)  
Internet Access  
External DNS  
Time Offset  
Root filesystem free space



## Troubleshooting Commands

When you click on this link, the FPP will run several troubleshooting commands that can be useful to diagnose problems and create a report for each section of FPP.

## Troubleshooting

Status/Control ▾ Content Setup ▾

### Troubleshooting Commands

- [Interfaces](#)
- [Wireless](#)
- [Wireless](#)
- [Routing](#)
- [Default Gateway](#)
- [Internet Access](#)
- [Block Devices](#)
- [Partitions](#)
- [Filesystems](#)
- [Mounts](#)
- [Date](#)
- [NTP Peers](#)
- [RTC](#)
- [Memory](#)
- [Uptime](#)
- [CPU Utilization](#)
- [CPUInfo](#)
- [USB Device Tree](#)
- [USB Devices](#)
- [Sound Cards](#)
- [Mixer Devices](#)
- [Midi Devices](#)
- [Video](#)
- [Kernel Version](#)
- [Kernel Modules](#)
- [i2cdetect](#)
- [Processes](#)
- [FPP\\_Cape\\_Detect\\_Log](#)
- [FPP\\_RTC\\_Log](#)
- [FPP\\_Init\\_Log](#)
- [FPP\\_Post\\_Network\\_Logs](#)
- [FPP\\_OLED\\_Logs](#)
- [FPP\\_FPPD\\_Logs](#)

### Interfaces: ifconfig -a

```
SoftAp0: flags=4098 mtu 1500
  ether b8:27:eb:34:ab:4b txqueuelen 1000 (Ethernet)
  RX packets 0 bytes 0 (0.0 B)
  RX errors 0 dropped 0 overruns 0 frame 0
  TX packets 0 bytes 0 (0.0 B)
  TX errors 0 dropped 0 overruns 0 carrier 0 collisions 0

eth0: flags=28605 mtu 1500
  inet 192.168.1.100 netmask 255.255.255.0 broadcast 192.168.1.255
  inet6 fe80::ba27:ebff:fe61:fe1e prefixlen 64 scopeid 0x20
  ether b8:27:eb:61:fe:1e txqueuelen 1000 (Ethernet)
  RX packets 2484782 bytes 532390720 (507.7 MiB)
  RX errors 0 dropped 0 overruns 0 frame 0
  TX packets 1551964 bytes 324460923 (309.4 MiB)
  TX errors 0 dropped 0 overruns 0 carrier 0 collisions 0
```

In the upper section, it will list the different sections of FPP that a report is created and clicking on one will take you to that section.

## SSH Shell

You can use the SSH Shell for advanced operations or troubleshooting using Linux commands.

The user is fpp and the password is falcon.

Normally users do not need to use the SSH Shell for operations or configuring the FPP. The SSH Shell is typically used by advanced users that want to customize the FPP.

# Glossary

**Absolute Channel-** A numbering system to uniquely identify each channel in each pixel and/or DMX device. It is simply 1 to the last channel needed. In xLights, you can have gaps in the numbering sequence. Due to the number of pixels utilized in most displays, the total number of channels can become quite large and difficult to manage.

**BBB-** A single board computer used to play sequences or act as a controller interface for animated holiday lighting. BBB is an acronym for BeagleBone Black. This acronym is commonly used for all of the BeagleBone series Single Board Computers.

**Broadcast-** A method of transmitting network data where the same data is sent to every device on the network.

**btrfs-** A filesystem for Linux that implements advanced features including compression but requires more CPU usage.

**Channel-** An identifier for a component in a lighting display. This is commonly used for pixels to set the color and brightness, but it can also be used for other items such as DMX channels for other components.

**DHCP-** Dynamic Host Configuration Protocol is a network management protocol where IP addresses can be dynamically assigned to devices on a network. This allows devices the ability to automatically communicate within a network. The IP address assigned to a device is not a permanent assignment and a device can get a different IP address the next time it connects to the network. To utilize DHCP, you have to have a DHCP server in your network. Most routers have a DHCP server on them.

**DNS-** Domain Name System is a naming system for devices or domains in a network. All devices in a network are identified by an IP address, such as 192.168.0.1. The DNS allows users to use more human friendly Host Names to access devices on the network. That way you can type something like google.com to access their website. But in reality Google's website is actually 172.217.11.238 (that is one of several devices on Google's domain.) This will also allow you to type something like fpp or whatever other host name you have saved on your FPP or other devices in your local network. To utilize DNS, you have to have a DNS server in your network and it has to be identified in the network settings. Most routers have a DNS server on them.

**E1.31-** A network protocol that is used to transmit DMX data. This is the most commonly used protocol in the animated holiday lighting hobby.

**Effect-** is a small sequence usually for just one model and can be used to overwrite the data that is being played by a sequence. It is commonly used with an event or via a manual trigger.

**eMMC-** Is a flash memory on the BeagleBone Black and BeagleBone Green computers. You can store the FPP operating system on the eMMC if you want.

**eth0-** The wired network portion of the FPP.

Event- An event can be a sequence or a script to run when a trigger is activated or it can be activated manually through the FPP interface.

ext4- The standard file system for Linux operating systems.

FPP- Falcon Player is a widely used player and operating system used in animated holiday lighting.

fseq file- The standard format for the raw data files used to inform controllers how to illuminate each light or which DMX channel to be activated.

Gateway- The IP address that a device will send network data to that it doesn't know how to properly route. This is usually your router or a FPP device where it is connected to two different subnets.

Git- A distributed version control system for coordinating work among developers and the core of the Github software hosting system.

Host Name- A human friendly name that you can assign a device to access through a web interface instead of typing the IP Address.

IP address- A numerical label to address devices in a network. This number is four parts separated by a decimal point. Each part can be between 0 and 255.

Master/Remote- An FPP method to synchronize several FPP devices by sending small sync signals to all of the remotes. This can be useful for very large displays or displays that are widespread and running Ethernet cables could be problematic.

Multicast- A method of transmitting network data where the same data is sent to all the devices that requested it but not to the devices that did not request it..

MultiSync- A way to identify relevant FPP instances in a Master/Remote configuration and to keep them synchronized with each other

Netmask- A numerical mask to identify the size of a subnet. This is typically 255.255.255.0 for most home networks.

Network- A group of devices connected through a digital telecommunications network to provide a method for these devices to share data.

NTP- Network Time Protocol is a networking protocol used to keep network system clock synchronized with the accurate time.

P10/P5 panel- Display panels that are typically 6 inches in height by 12 inches in width. These panels have pixels that are spaced according to the panel type, i.e. P5 panels have pixels that are spaced 5 millimeters apart. These panels can be combined to make larger panels and are commonly used as a "Tune To" sign to display informational text and/or more detailed graphics.

**Pixel-** This usually refers to an LED light with individually addressable channels so that each pixel in a string/strand can be identified and lighted in a color that is independent from the other pixels in the string.

**Playlist-** A playlist is an ordered list of various items to display and is used by FPP to control the lights and other props used in the animated lighting hobby.

**Plugin-** A component developed to provide more functionality to the FPP.

**Port-** The physical connection point on a controller for pixel strings.

**Raspberry Pi-** A single board computer used to play sequences or act as a controller interface for animated holiday lighting.

**Real Time Clock-** A component that contains a highly accurate timing crystal used to keep accurate time in certain devices.

**SBC-** Single Board Computer is a small complete computer built on a single circuit board. The Raspberry Pi and BeagleBone series computers are the most commonly used single board computers in the holiday lighting community.

**Script-** A small program code used to perform a specific function in the FPP interface.

**SSH-** Secure Shell is a network protocol that gives users a secure way to access devices through a command line interface. This is usually for advanced users.

**Subnet-** A portion of a bigger network that is usually composed of devices within a range of IP addresses defined by the first 3 segments of a 4 segment IP address, i.e. 192.168.0.xxx where 192.168.0 is the “subnet” and xxx is the identifying address for each device in that subnet..

**Tethering-** A method of connecting two network devices directly to communicate between them with no routers or switches needed. This can be done through an Ethernet cable, USB cable or through Wi-Fi.

**UI-** User Interface. The method in how a user interacts with a device and/or program. FPP’s User Interface is through a web-page based interface.

**Unicast-** A method of transmitting network data where the data for each device is sent to only that device. This is usually more efficient than Multicast or Broadcast unless you want or need to send the same data to multiple devices.

**Universe/Channel notation-** A numbering system to uniquely identify each channel in each pixel and/or DMX device. It breaks the channels down into user defined groups called Universes. The user can define each Universe to be up to 512 channels in size. This is usually easier to manage than Absolute Numbering. You can have gaps in the Universes and they don’t have to start at the number one.

**uSD card-** A Micro SD card that is used to store computer data. In FPP this is usually the FPP operating system and related files.

wlan0- The Wi-Fi or wireless network portion of the FPP.

WPA Pre Shared Key- The password to gain access to a Wi-Fi network.

WPA SSID- The technical name for a wireless network.

# Advanced Options

This section is for information that is beyond the basic Setup and configuration settings.

## Network Considerations

In order for all of your devices to communicate with each other, the network has to be configured properly and this has been the source of many people's problems, especially when you are just beginning in this hobby.

In order to communicate with your devices and setup your show network, you need to know what your home router IP address is and what subnet it is using. It is usually 192.168.0.1 or 192.168.1.1. These are the most common, but other addresses may be used. If you don't know what your home network's router IP address is, sometimes it is on a label on the router or you can use the command ipconfig in a command prompt on your PC (ifconfig on Macs). Depending on how your computer is connected to your home network (wireless or wired) the default gateway will be listed in different sections of the report.

IP addresses are in the format of 4 groups of numbers separated by a "." And the numbers will range from 0 to 255. So an IP address will look something like 192.168.0.1. For most home networks the first 3 groups of numbers are called the subnet; in this case the subnet is 192.168.0 (192.168.0.1). The host number is the last group of numbers; in this case it is 1 (192.168.0.1). It is important that you know what subnet your home network is using because devices can only communicate directly with devices that are in the same subnet. In order for devices to communicate with devices on a different subnet, you have to tell the systems how to communicate with each other, (more on that later.)

## Common Network Setups

There are four types of a "show network" that are the most common; Standalone, Wired on Home Network, Wired on Separate Show Network, and Master/Remote. Each method has advantages/limitations and you will need to decide what works best for you. You can also combine different network configurations depending on your needs.

Below are some examples and in the chart below the FPP(s) and controller(s) are the typical settings to create your network. You will need to know what the IP address is for your home network's main router. When numbering your devices, it is suggested to go on the higher end of the range because your router will usually typically, but not always, assign DHCP addresses at the bottom end of the range.

**The following examples will assume that your home network's router's IP address is 192.168.0.1. If that is not the case, then make the appropriate changes as explained above.**

### Standalone

This method has the light show totally separate from the home network without any interaction between the two networks. This has a few advantages/drawbacks.

- There is no connection to the internet so you will have to manage updates and other administrative functions by some manual process.



- There is no Network Time Protocol available so you will need some method to keep accurate time if you are going to use a schedule.
- You will need either a dedicated computer on the standalone network to make changes to your FPP and/or controller settings or a computer that you can change connections from your home network to your standalone network. **You will need to manually configure the Ethernet IP address on your computer to be in the subnet range you want to use.**
- If you have only one controller, then connect FPP directly to the controller with an Ethernet cable connected to the appropriate ports.
- You will need Ethernet cables run from the switch to the FPP and each controller.
- Make sure you have the E1.31/DDP/Artnet Channel Outputs for each FPP set correctly.
- FPP mode needs to be set to Player. .
- If you want FPP to process E1.31/DDP/Artnet data from an outside source, such as testing directly from xLights, then you will need to enable/configure the Channel inputs (refer to [Channel Inputs](#) for more information.)

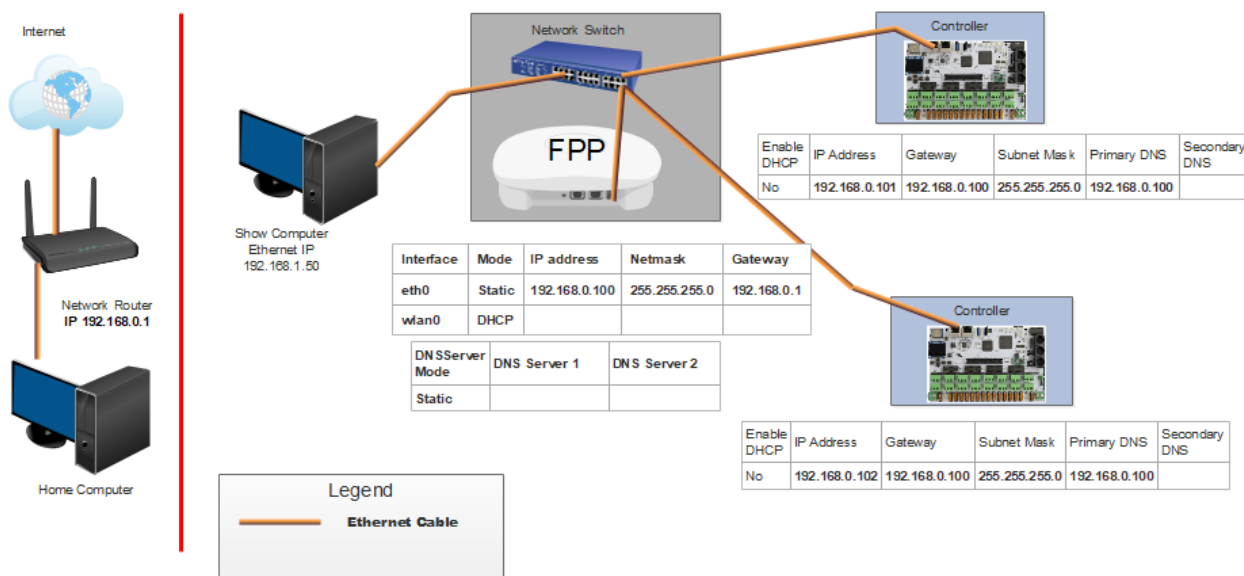

Note: In this case, you can make your FPP IP address any valid IP address. All of your controllers, FPP devices and computer will need an IP address that have the same first 3 sets of numbers as the FPP, and the last set of numbers must be unique.

## Wired on Home Network

This method will use your home network for the E.131/DDP data transmission.

- All of your FPPs and controllers will have connection to the internet so updates can be performed from your home computer.
- Your FPP will have access to a Network Time Protocol so it will keep time for scheduling if you set up the NTP.
- You will need Ethernet cables run from the home network router to the FPP and each controller.
- Your show data will be transmitted using your home network which might cause a slowdown or lag for other devices on your home network, unless you use the method indicated using a network switch..
- Make sure you have the Channel Outputs for each FPP set correctly.

- FPP mode should be set to Player.
- If you want FPP to process E1.31/DDP/Artnet data from an outside source, such as testing directly from xLights, then you will need to enable/configure the Channel inputs (refer to [Channel Inputs](#) for more information.)

### Without a Switch

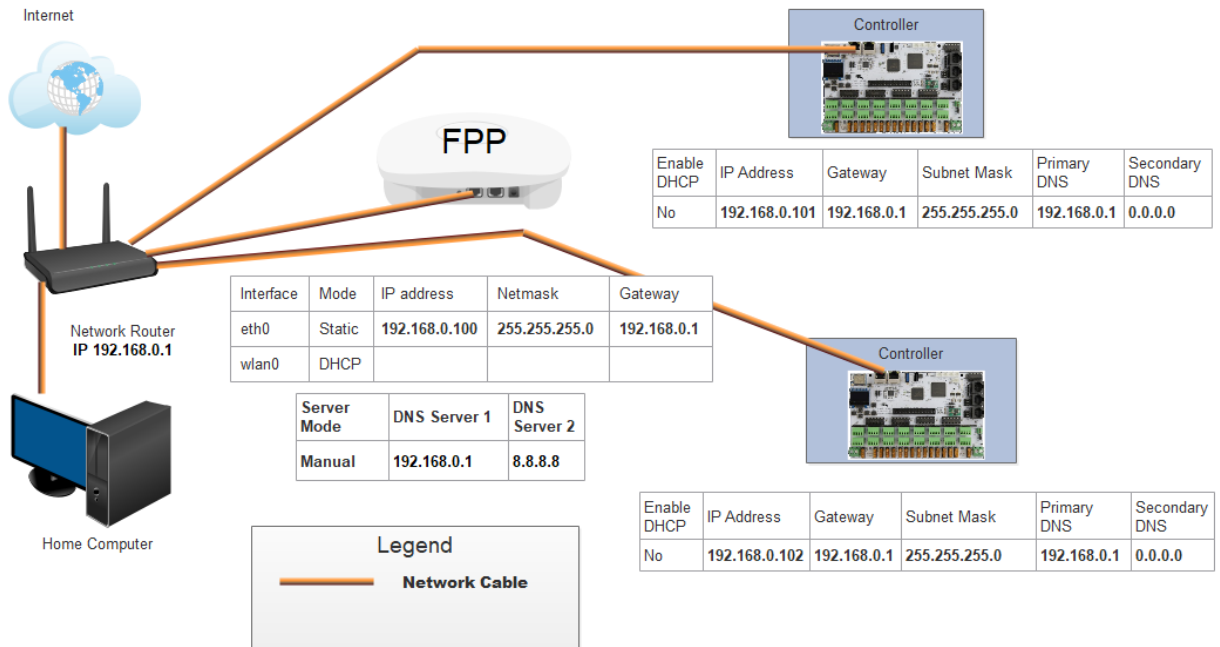

### With a Switch

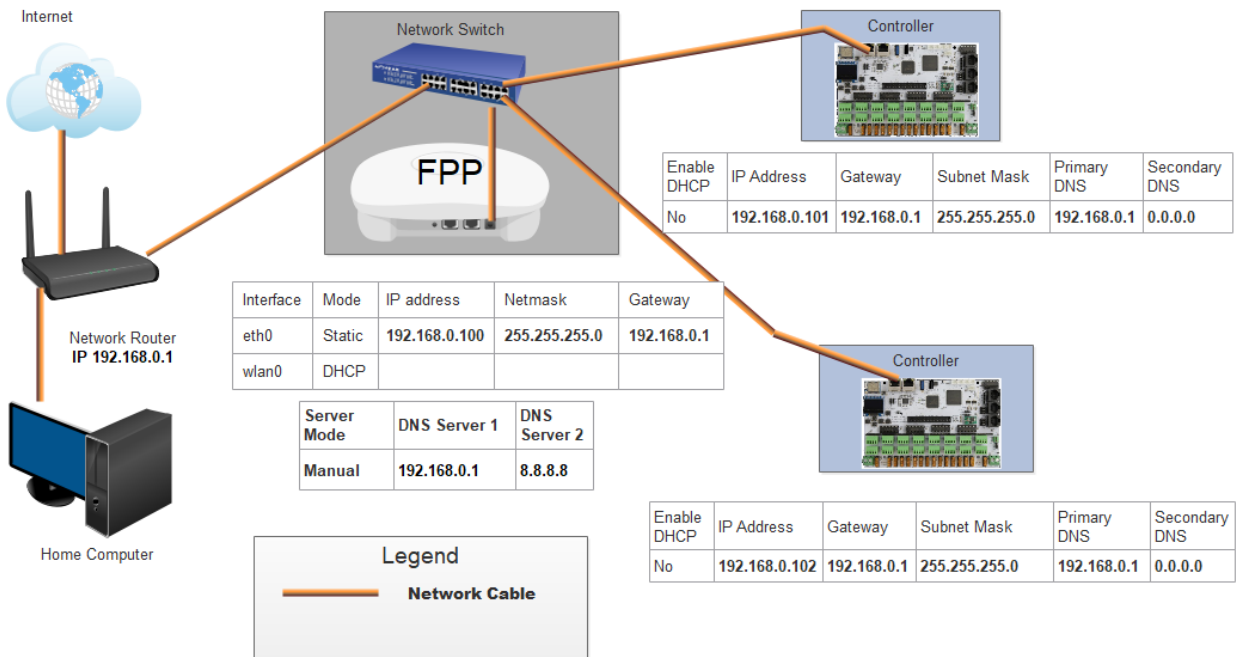

Note: All of the IP addresses have the same subnet (first 3 sets of numbers) as the home network router, in this case, 192.168.0 and the last set of numbers is unique. All of the gateways are the same as the IP address of the home network router, in this case,

192.168.0.1. Your network might be different depending on your home network router's address. Do not enter a SSID or password on the wlan0 interface.

## Wired Separate Show Network

This method will provide a separation of the network traffic from your home network traffic and still allow internet access for FPP/Controller updates. This is one of the more common methods that are used. In order to access the controllers that are on the show network, you have to provide a method for the two networks to communicate with each other. There are two methods; [adding a static route](#), either in your router or a route path in your computer, or configuring your FPP device to act as [a Proxy Host](#).

If you create a static route in your router, then all computers on your home network can access your controllers, but not all routers have a static route function. When adding a route path in a Windows computer, you can make it persistent so that if you turn off the computer, you can still access the controllers when you turn it back on. Macs don't have the persistent attribute to their route function so you will have to re-enter the route if you reboot your computer.

- All of your FPPs and controllers will have connection to the internet so updates can be performed from your home computer (if you added a static route in your router).
- Your FPP will have access to a Network Time Protocol so it will keep time for scheduling.
- If you have more than one controller then you will need a switch. If you only have one controller, then connect FPP to the controller with an Ethernet cable connected to the appropriate ports.
- You will need Ethernet cables run from the switch to the FPP and each controller.
- Make sure you have the Channel Outputs for each FPP set correctly.
- Make sure you have the Enable Routing between network interfaces checked in the Network settings of the FPP if you are using one of the Static Route methods.
- FPP mode should be set to Player..
- If you want FPP to process E1.31/DDP/Artnet data from an outside source, such as testing directly from xLights, then you will need to enable/configure the Channel inputs (refer to [Channel Inputs](#) for more information.)

### One Controller

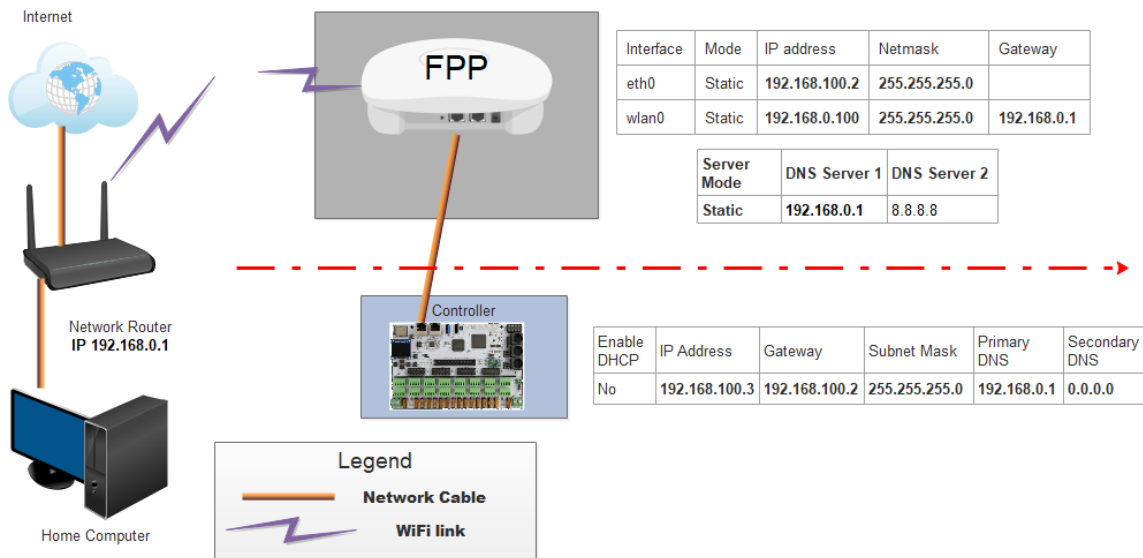

## Multiple Controllers

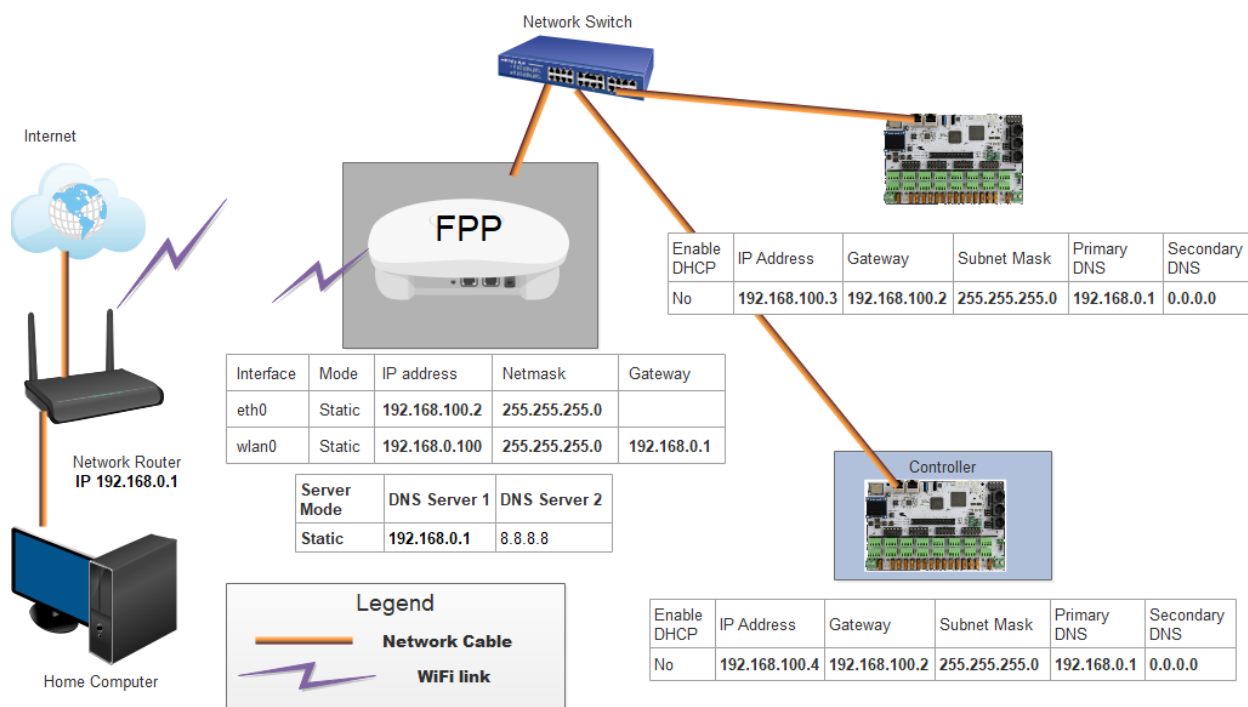

Note: The FPP wlan0 IP address will be on the same subnet (first 3 sets of numbers) as the home network router, in this case, 192.168.0. The eth0 on the FPP and the controllers will be on a different subnet than the wlan0 subnet and the controllers will be on the same subnet as the eth0 subnet of your FPP device. In this case, 192.168.100 (you pick the subnet). Do not put a gateway address for the eth0 on the FPP. The gateway on the FPP wlan0 should be the same as your home router IP address. The gateway(s) on all of the controllers should be the same as the eth0 IP for your FPP. You will need to set up routing to your controllers (see [Configuring a Static Route](#)). Your network might be different depending on your home network router's address.

## MultiSync/Remote

This method eliminates the need for Ethernet cables connecting your FPPs and controllers even though you could use a wired network if you want. You will need an FPP device at each remote location. This is one of the more common methods that are used especially in larger shows or ones that are spread across a large area. The Main Player will be configured to send MultiSync packets and will send very small sync packets typically over your wireless network. Each FPP will need a copy of the .fseq files to play (or the video if you are using the remote FPP to play a video through a projector/monitor). xLights has a function called [FPP Connect](#) that is the recommended method for uploading sequences and settings to your FPP devices. If your FPP Remotes are connected to a separate controller that are on a different subnet, then you have to provide a method for the two networks to communicate with each other. There are three methods; you can set the FPP device to be a Proxy Host (see [Proxy Settings](#) in the Status/Control section), adding a static route in your router or creating a route path in your computer. If you [create a static route](#) in your router, then all computers on your home network can access your controllers, but not all routers have a static route function. When adding a route path in a Windows computer, you can make it persistent so that if you turn off the computer, you can still access the controllers when you turn it back on. Macs

don't have the persistent attribute to their route function so you will have to re-enter the route if you reboot your computer.

- All of your FPPs and controllers will have connection to the internet so updates can be performed from your home computer. (if you added a static router to your router)
- Your FPP will have access to a Network Time Protocol so it will keep time for scheduling if you set up the NTP.
- You do not need a network switch.
- You will need an FPP device at each remote location.
- You will not need any Ethernet cables connecting the different FPP devices.
- You will need a good Wi-Fi connection at all of your remote FPP devices.
- The Player FPP will need all media and sequence files stored on it.
- Each Remote will need all the sequence files and any videos, etc. that it will be playing directly stored on it. Note: videos are only needed if you are playing them directly like through a projector or Monitor.
- Make sure you have the Channel Outputs for each controller set correctly and only for the controller that is physically connected to it.
- The FPP device that you designate as the player will need to be set to Player Mode and have the Enable MultiSync Packets checked (refer to [MultiSync](#) for more information).
- The Remote FPP devices will need the Mode set to Remote.
- If you have a controller that is integrated with an FPP device, you can use that as your Player. You don't need a dedicated FPP device to be your Player.

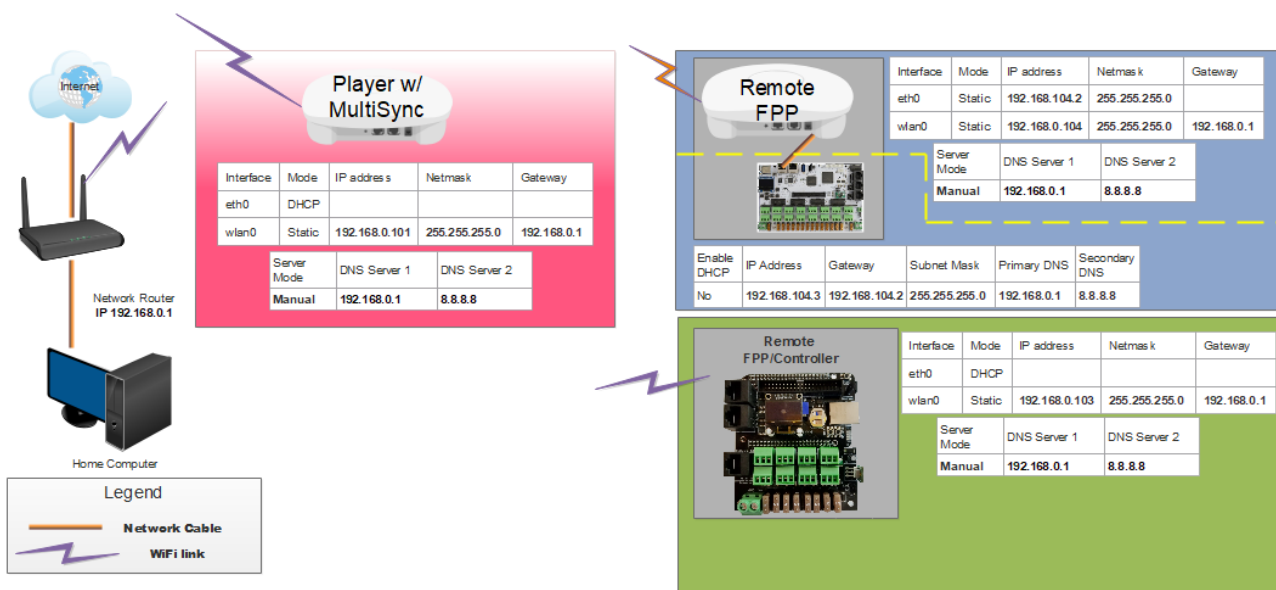

Note: All of the FPP's wlan0 IP addresses will be on the same subnet (first 3 sets of numbers) as the home network router, in this case, 192.168.0. The eth0 on the Remote FPPs will each be on a separate subnet (you choose) and the attached controller will have an IP address in the same subnet as the eth0 subnet of the attached FPP. Do not put a gateway address for the eth0 on the FPPs. All of the FPP wlan0 gateways are the same as the IP address of the home network router, in this case, 192.168.0.1. Your controller's gateway will be the eth0 IP of the attached FPP. You will need to set up routing to each of your controllers (see [Configuring a Static Route](#) for more information). If you have 3 controllers, then you will have 3 routes. (If your controller is a hat or cape attached to a Pi/BB, then you don't need to

create a route for those) Your network might be different depending on your home network router's address.

For an in depth discussion, refer to this post:

<https://falconchristmas.com/forum/index.php/topic,4231.0.html>

## Virtual Matrix

The Virtual Matrix function in the Channel Outputs section of FPP enables you to use the HDMI port to output sequence data to a projector or TV/Monitor. In order to use the Virtual Matrix output, you will need to create a Matrix model in your sequencing software and associated DDP or E1.31 Universes (DDP is recommended). Like all models, the Model configuration in your sequencing software needs to match your Virtual Matrix configuration. The resolution of your display will be dependent on the resolution of your matrix, but be careful the number of channels can become quite large. It is recommended to use a MultiSync configuration for your FPP Device if it is going to be a Remote.

### Creating a Virtual Matrix

A higher resolution Virtual Matrix will create a larger .fseq file and render times. It will also add to your network traffic (Unless you are running a Multisync/Remote mode)

You can use 1920 by 1080 as the matrix resolution but it is not recommended since that would require the processing of over 6 million channels. A decent resolution is 192 by 108 but you can experiment with different settings as needed. FPP has a maximum channel capacity of 8MB so you really can't go much bigger than 1920 x 1080.

If you want a higher resolution you might try outputting video directly from the FPP (see next section)

For this example we will use a Virtual Matrix of 192 x 108

- Create the Network channels in the Controllers section of your sequencing software, DDP is recommended. In xLights you would select the Add Ethernet option. Because we are using a 192 x 108 Virtual Matrix, we will need to create 62,208 channels using the following settings:
  - Name- Create a name for your controller.
  - Description- Create a Description that identifies this FPP device if you want. (this is optional)
  - Active- Set this to Active.
  - Vendor- Select FPP
  - Model- Select Virtual Matrix
  - IP Address- Set this to the IP address of the FPP Device that will be displaying your effects.
  - Protocol- Select DDP
  - Id- Select an ID, this must be one that is not in the same range as your existing Universes/Ids. Something like 5000 would usually work.
  - Channels per packet- Leave at the default of 1440.
  - Keep Channel Numbers- Leave this checked.



- Channels- Set to the number that you need for your Virtual Matrix (in this case, 62,208 which is 192 x 108 x 3.)

Name	Protocol	Address	Universes/Id	Channels	Description
F16V3	E131	192.168.1.102	101-108	4096 [1-4096]	
F8PB_FrontYard	E131	192.168.1.101	201-209	4590 [4097-8686]	
FrontMatrix	DDP	192.168.1.103	5000	64512 [8687-73198]	

Name	FPP VirtualMatrix
Description	
Id	5000
Auto Layout Models	<input type="checkbox"/>
Auto Upload Configuration	<input type="checkbox"/>
Active	Active
Vendor	FPP
Model	Virtual Matrix
Suppress Duplicate Frames	<input type="checkbox"/>
IP Address	192.168.1.250
Protocol	DDP
Channels Per Packet	1440
Keep Channel Numbers	<input checked="" type="checkbox"/>
FPP Proxy IP/Hostname	
Channels	62208
Models	

- Click On Save
- Create a matrix in your sequencing software with the resolution you want. (For this example we are using 192 x108) Using the following settings:
  - Name- Create a meaningful name for your matrix (for this example we are using Virtual Matrix)
  - Direction- Horizontal
  - # Strings- Enter the resolution height (for this example we will use 108.)
  - Nodes/String- Enter the resolution width (for this example we will use 192.)
  - Starting Location- Top Left
  - Start Channel- Click the Universe Number button and select the DDP Universe/ID you created for your matrix.

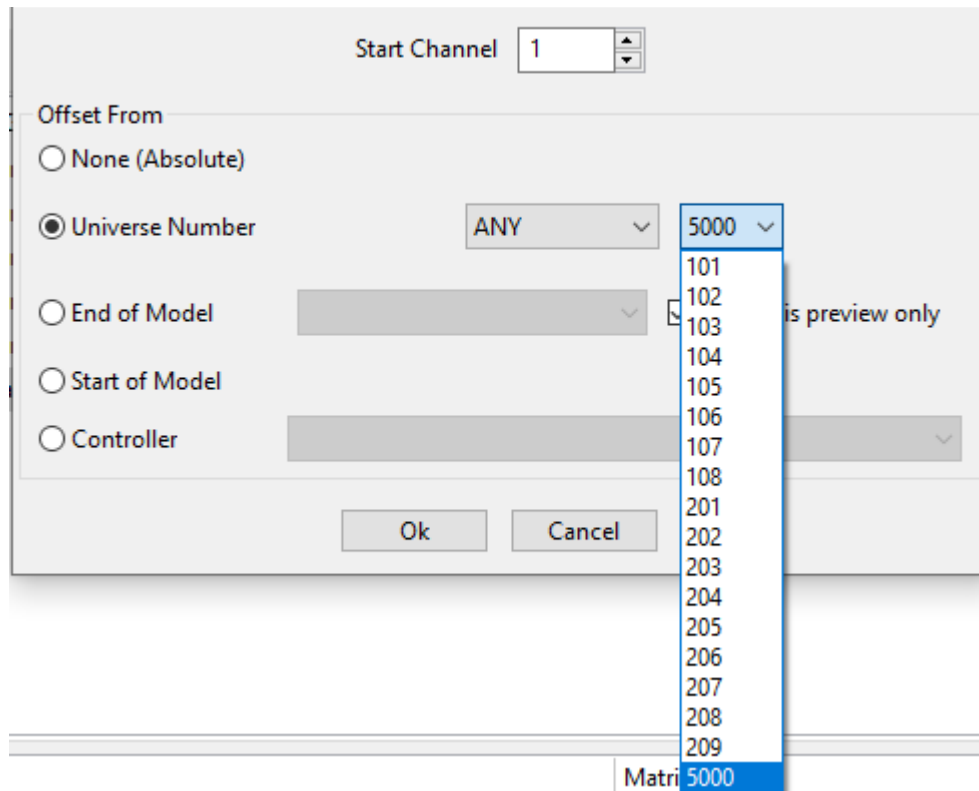

- Click on OK
- Click on Save
- Note the beginning channel number for your Matrix, in this case it is 8687.



- Create the Virtual Matrix in FPP (your Pi needs to have the monitor connected and turned on before booting up FPP).
  - Go to your Channel Outputs and the Other tab and select the Add button.



## Other Outputs

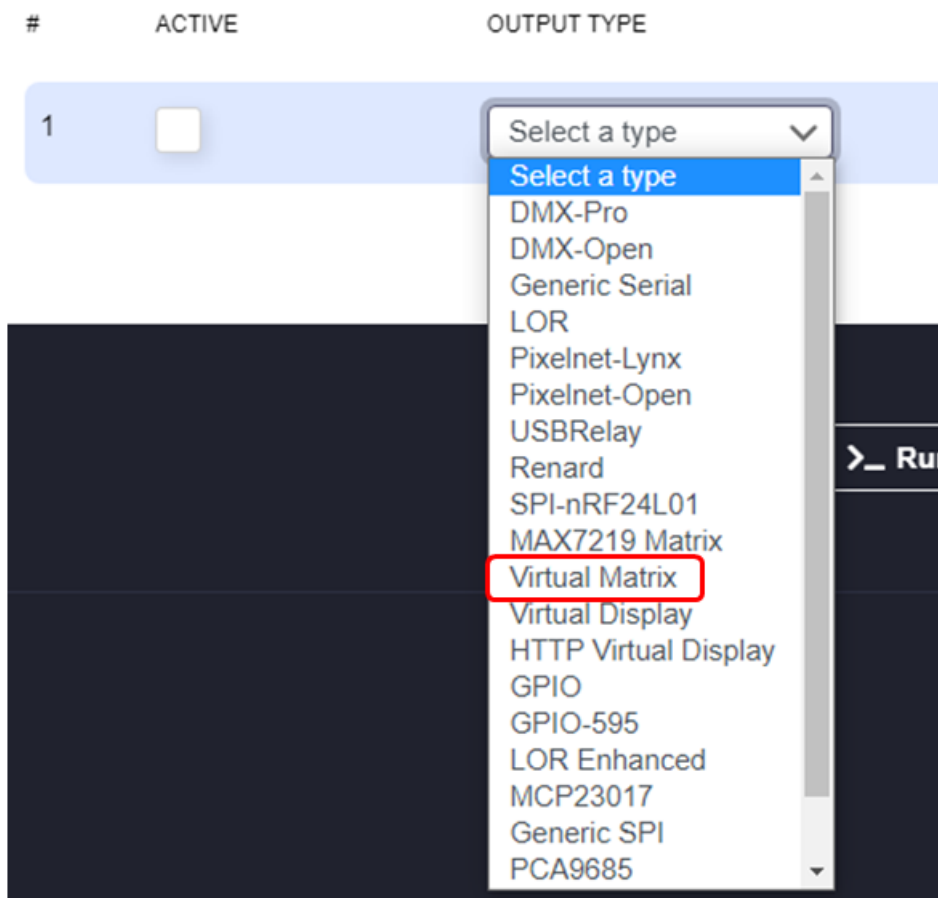

- Select the Virtual Matrix type and enter the following options:
  - Active box- Make sure this is checked
  - Start Channel- Enter the channel you noted in xLights that your matrix starts at (in this example it is 8687.)
  - Description- You can enter a description for this Virtual Matrix.
  - Width- Enter the width of the matrix you created in xLights (for this example we are using 192.)
  - Height- Enter the height of the matrix you created in xLights (for this example we are using 108.)
  - Color Order- Leave it at the default RGB
  - Invert- This is normally left unchecked, but if you need to invert your display, then check this box.
  - Port- If your Raspberry Pi has only one HDMI port then leave this at the default of fb0. If you are using a Pi4 with two HDMI ports then you can select fb0 or fb1
  - Scaling- You can select the method of scaling the output. The Hardware method is the default and usually works the best.
  - Click on Save
  - Click on the Restart FPPD in the orange banner.

## Channel Outputs

Status/Control ▾

E1.31 / ArtNet / DDP / KiNet

Pixel Strings

LED Panels

Other

### Other Outputs

#	ACTIVE	OUTPUT TYPE	START CH.	CHANNEL COUNT	OUTPUT CONFIG
1	<input type="checkbox"/>	VirtualMatrix	8687	62208	Description: VirtualMatrix Width: 192 Height: 108 Color Order: RGB ▾ Invert: <input type="checkbox"/> Port: fb0 ▾ Scaling: Hardware ▾

- Configure FPP to output your HDMI.
  - Go to the Status/Control>Settings page. Make sure the Default Video Output device is set to HDMI.

You can now create sequences in your scheduling software and it will play on the HDMI port on your Raspberry Pi to your TV/Monitor or through a projector.

## Playing Video

Besides playing video as part of a sequence file there are two other ways of directly playing a video through the HDMI port on your Raspberry Pi. In either case you have to configure your FPP device to output your HDMI. The advantage of playing a video directly is that you can get a higher resolution. The biggest disadvantage is that the video might not be synced exactly with your audio file, usually it is very close and not noticeable.

Go to the Status/Control>Settings page. Make sure the Default Video Output device is set to HDMI.

- Syncing the video to the Sequence being played.
  - On a Raspberry Pi running in Player Mode
    - Create your playlist in FPP using the video file as the audio source.-If you didn't use the same video file as the audio source in your sequencing software then there is a possibility that the video timing won't match the sequence.
    - When the video first starts, it might be slightly out of sync but will get in sync in usually less than a second or two.
- Starting Video Manually
  - You can start a video manually through several different methods, the video will not be synced to the sequence so the timing might drift a little especially on longer videos. This can be useful if you are playing short video clips but want the higher resolution. If syncing is important and manually triggering the video does not give you the desired results, then you should consider using the video as part of the actual sequence. Here are the different methods of manually starting a video.

- As a Playlist entry.
- As an event in a sequence or other event trigger.
- Through the activation of scripts

## Virtual Display

You can have a TV/monitor display a “live” representation of your show by creating a Virtual Display. This will require a TV/Monitor to be connected to one of your Pi FPP devices via the HDMI port.

- Use FPP Connect in xLights to upload your models and full V2 sequence to the FPP device that you are going to use for your Virtual display.
- Go to the Status/Control>Settings page. Make sure the Default Video Output device is set to HDMI.
- Go to your Channel Outputs and the Other tab and select the Add button.

## Other Outputs

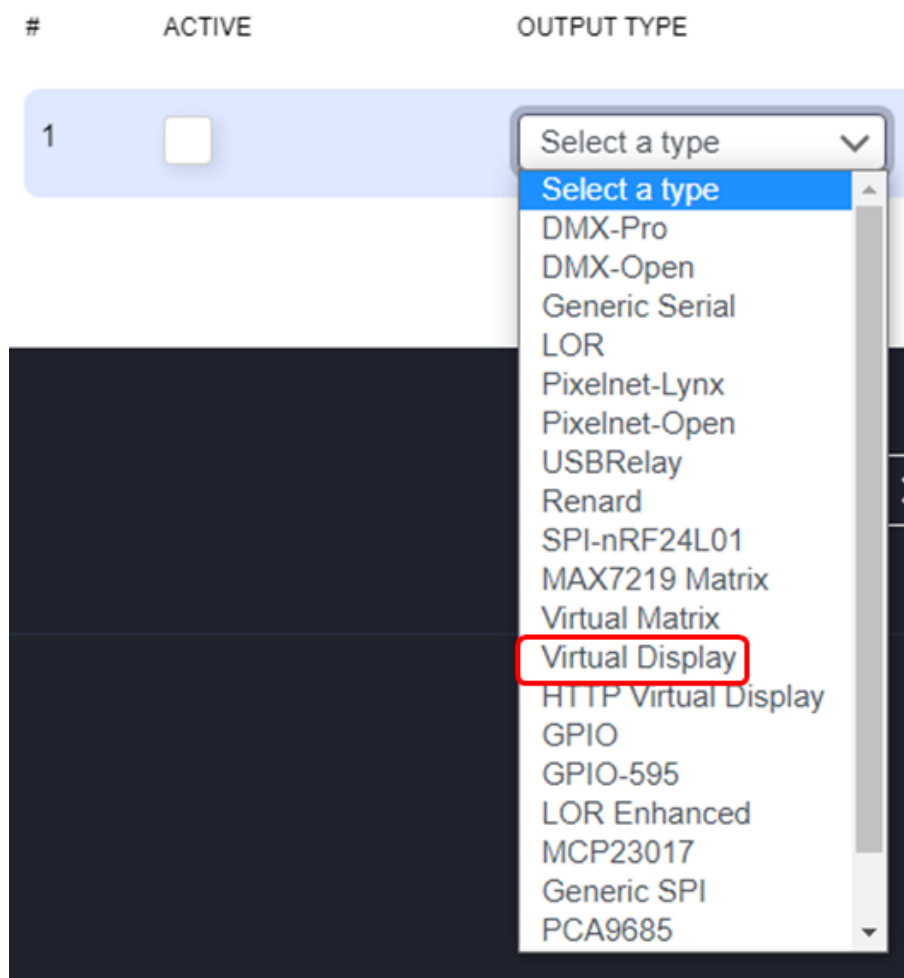

- Select the HTTPVirtual Display type and enter the following options:
  - Active box- Make sure this is checked
  - Start Channel- Leave this at the default of 1
  - Channel Count- Leave this at the default.

- Width- Leave this at the default of 1280
- Height- Leave this at the default of 1024
- Color Order- Leave it at the default BGR.
- Pixel Size- Leave this at the default of 2
- Port- Leave this at the default of fb0.
- Click on Save
- Configure this device just like any other controller. If running Standalone, configure the outputs for all of the channels, if using Player with MultiSync/Remote configure this FPP as a remote.

### Other Outputs

Delete
+ Add
Save

#	ACTIVE OUTPUT TYPE	START CH.	CHANNEL COUNT	OUTPUT CONFIG									
1	<input checked="" type="checkbox"/> VirtualDisplay	1	8388608	Width:	1280	Height:	1024	Color Order:	BGR	Pixel Size:	2	Port:	fb0

Now when your show is running you will get a “live” visual representation on the monitor connected to your FPP device.

## HTTP Virtual Display

You can view a “live” representation of your show from a web browser on your computer by creating an HTTP Virtual Display.

Use FPP Connect in xLights to upload your models and full V2 sequence to the FPP device that you are going to use for your HTTP Virtual display.

- Go to your Channel Outputs and the Other tab and select the Add button.
  - Select the HTTPVirtualDisplay
  - Active box- Make sure this is checked
  - Start Channel- Leave this at the default of 1
  - Channel Count- Leave this at the default.
  - Width- Leave this at the default of 1280
  - Height- Leave this at the default of 1024
  - Pixel Size- Leave this at the default of 2
  - Click on Save
  - Configure this device just like any other controller. If running Standalone, configure the outputs for all of the channels, if using Player with Multisync/Remote configure this FPP as a remote.

### Other Outputs

Delete
+ Add
Save

#	ACTIVE	OUTPUT TYPE	START CH.	CHANNEL COUNT	OUTPUT CONFIG					
1	<input checked="" type="checkbox"/>	HTTPVirtualDisplay	1	8388608	Width:	1280	Height:	1024	Pixel Size:	2

Now when your show is running, you can get to the HTTP Virtual Display from the Status/Control menu.

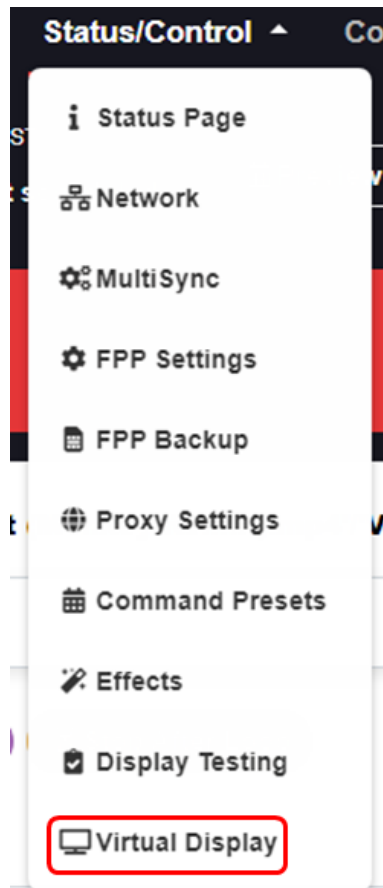

You will get a display something like this:

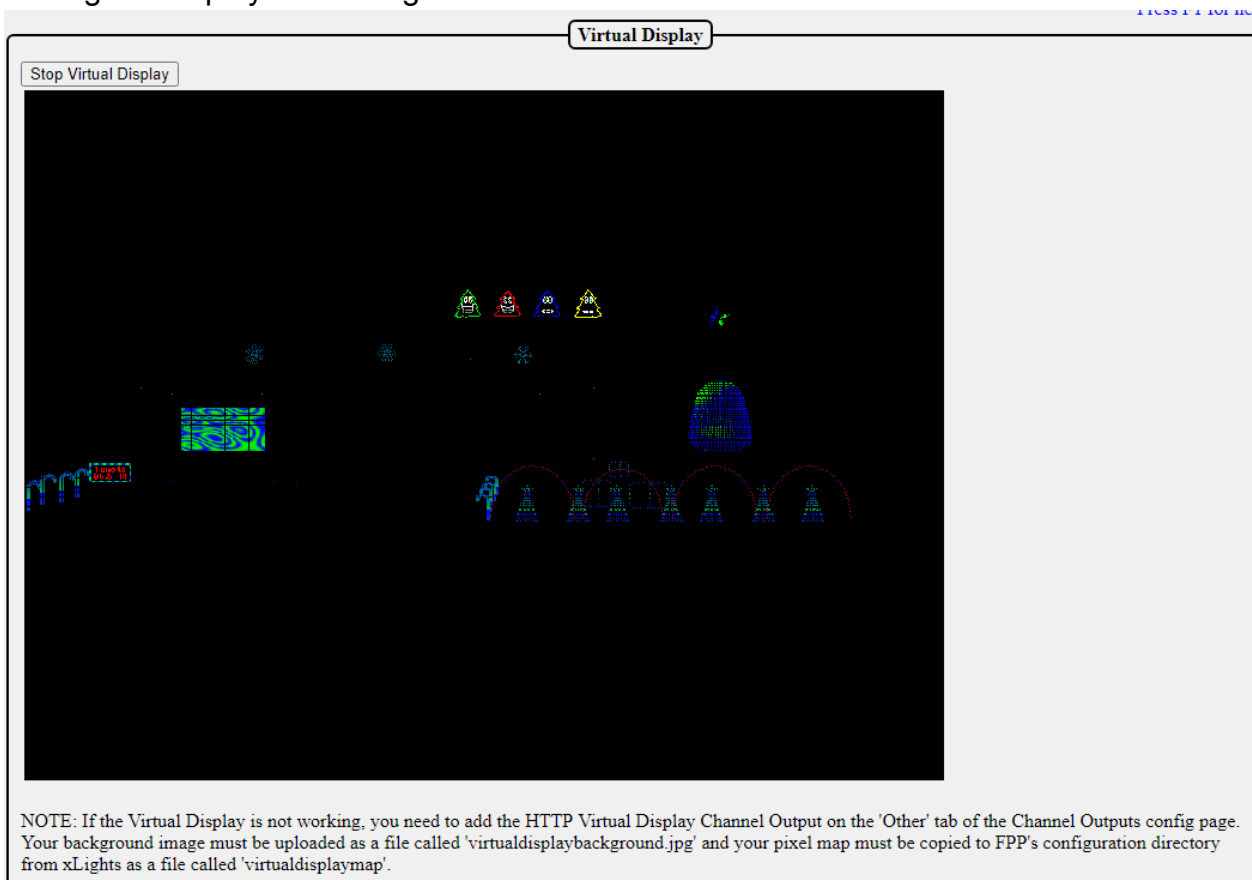

# Common Plugins

There are several Plugins available from the FPP install, but you are not limited to those. You can install Plugins from a third party or create your own. Plugins should have installation information on the developer's web page. Some of the more commonly used Plugins are:

- Big Buttons- This Plugin will create a web interface within FPP so that a user can click on one of several buttons that will start a predefined script.
- Matrix Tools- This plugin allows you to control a matrix to add text or a drawing in real time.
- Event Date- This will allow you to generate a dynamic countdown to a specific date and display the results on a matrix. This plugin requires a few other plugins to be installed in order to function properly
  - Message Queue Aggregator for Plugins- This is a repository to store and manage messages so that other plugins can send messages to this plugin for processing at a later time.
  - Message Queue to Matrix Overlay- This plugin will coordinate with the Message Queue Aggregator for Plugins to output the accumulated data.
  - Matrix Tools
- Plugin to download Weather information for Message Queue- This will allow you to get the current weather data for a certain location and display it on a matrix.

## Big Buttons

The Big Buttons Plugin will create a web page with several buttons so that a user can click on one of the buttons which will activate an FPP Command such as starting a playlist or a particular song. To install the Big Buttons Plugin, go to the Plugin Manager in the Content Setup section of FPP and click the Install Button.

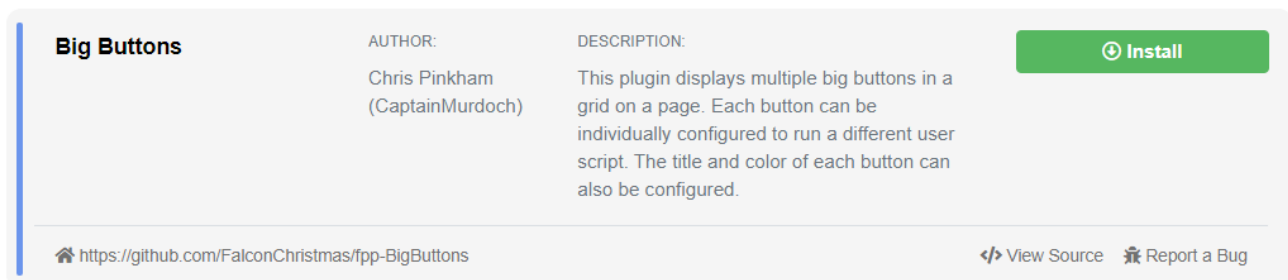

<b>Big Buttons</b>	AUTHOR: Chris Pinkham (CaptainMurdoch)	DESCRIPTION: This plugin displays multiple big buttons in a grid on a page. Each button can be individually configured to run a different user script. The title and color of each button can also be configured.	<a href="#">Install</a>
<a href="https://github.com/FalconChristmas/fpp-BigButtons">https://github.com/FalconChristmas/fpp-BigButtons</a>		<a href="#">View Source</a> <a href="#">Report a Bug</a>	

Once the Big Buttons Plugin is installed it will need to be configured. Go to the Content Setup tab and click on the Configure Big Buttons.

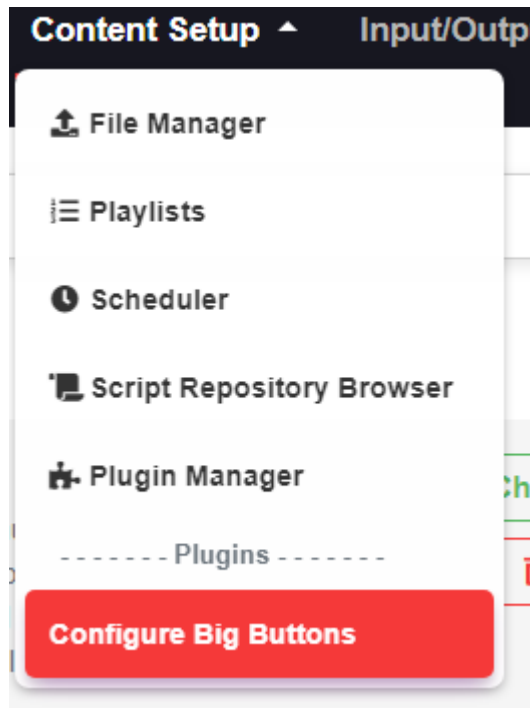

You can have several buttons and several tabs, each button can perform a different function. You can customize this page such as: set a title for your Big Button page, select a background color, put an icon on each button, select the color for each button, select the text size, and the text for each button.

You can configure your Big Buttons and the page from these settings: Then you will have several options:

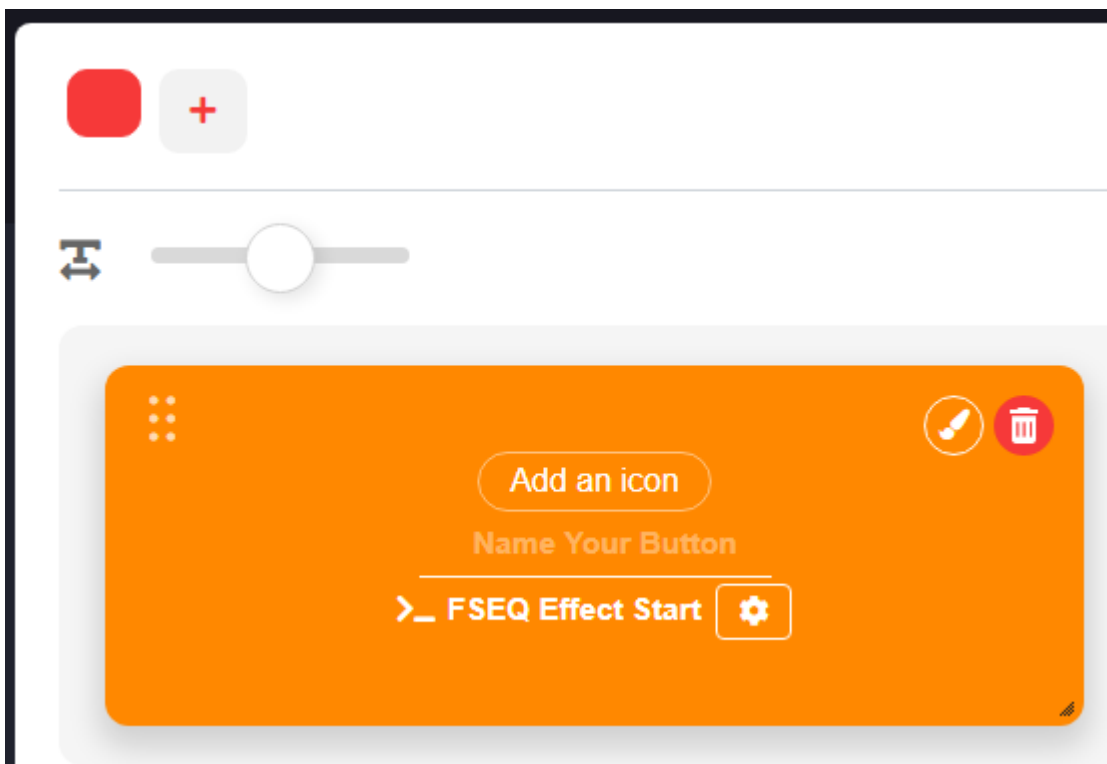



If you select this, you can add an icon for this button



Selecting this will give you the option for the button's color



This will delete the button.



Enter the text that you want on this button



You can edit the FPP Command that this button is using



This is the Tab for your Big Buttons Page if you hover over it you will get an edit icon



in order to configure how this Tab will look.

### Tab Settings ✕

---

Title:

Description:



---

🗑️ Delete This Tab
Done



buttons.

This allows you to adjust the text size that is displayed on the

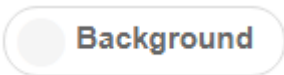

This allows you to set the Background color for your page.

This will demonstrate creating a four button page where three buttons will play a particular song and the fourth button will play the master playlist. You will need to create a master playlist.



Click on the

You will get a Command selector box, select FSEQ Effect Start.



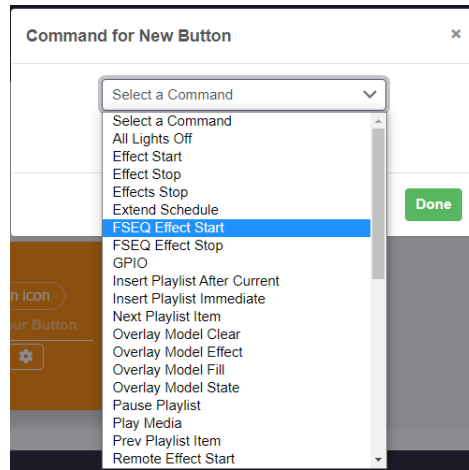

The first button we want to play Mary Did You Know so we will select that for our FSEQ Name and we don't want it to loop or run in the background so we will make sure those are disabled and click on Done when finished

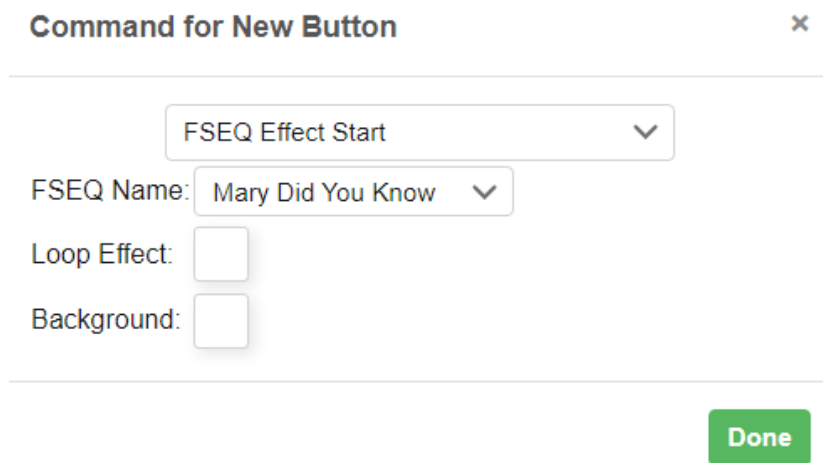

We will then name the Button, Mary Did You Know by entering it in the name location

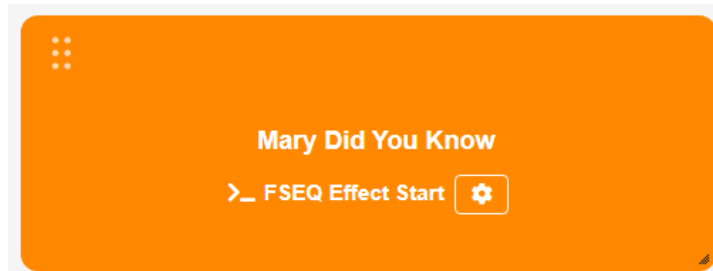

We will change the color of the button by editing the color to blue and click OK.

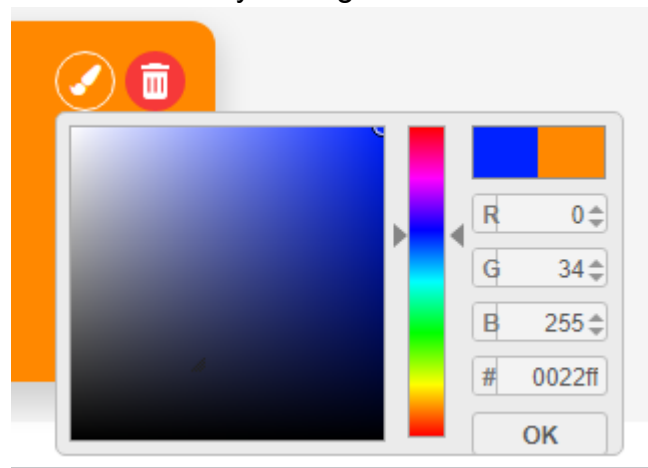

We will do the same thing for the other 2 buttons but a different color and text and the last button will use the Command of Start Playlist and select the Playlist.

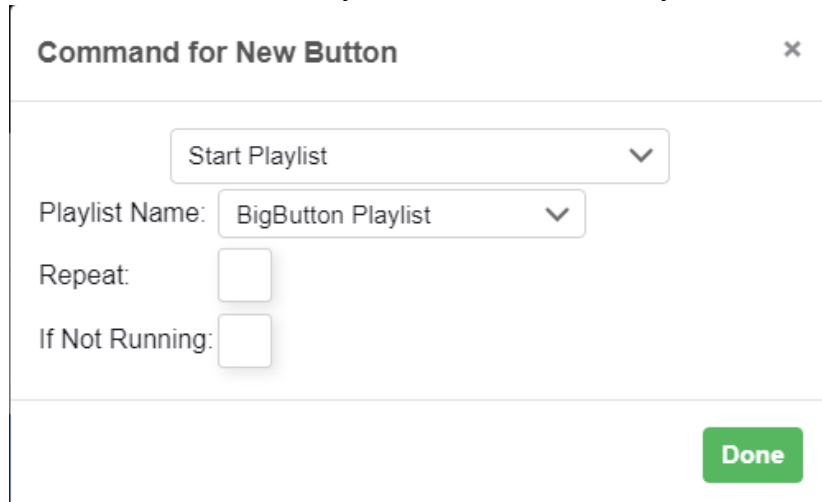

**Command for New Button** [X]

Start Playlist [v]

Playlist Name: BigButton Playlist [v]

Repeat:

If Not Running:

Done

When you are done with the settings, click on Save Buttons, the page will look something like this.

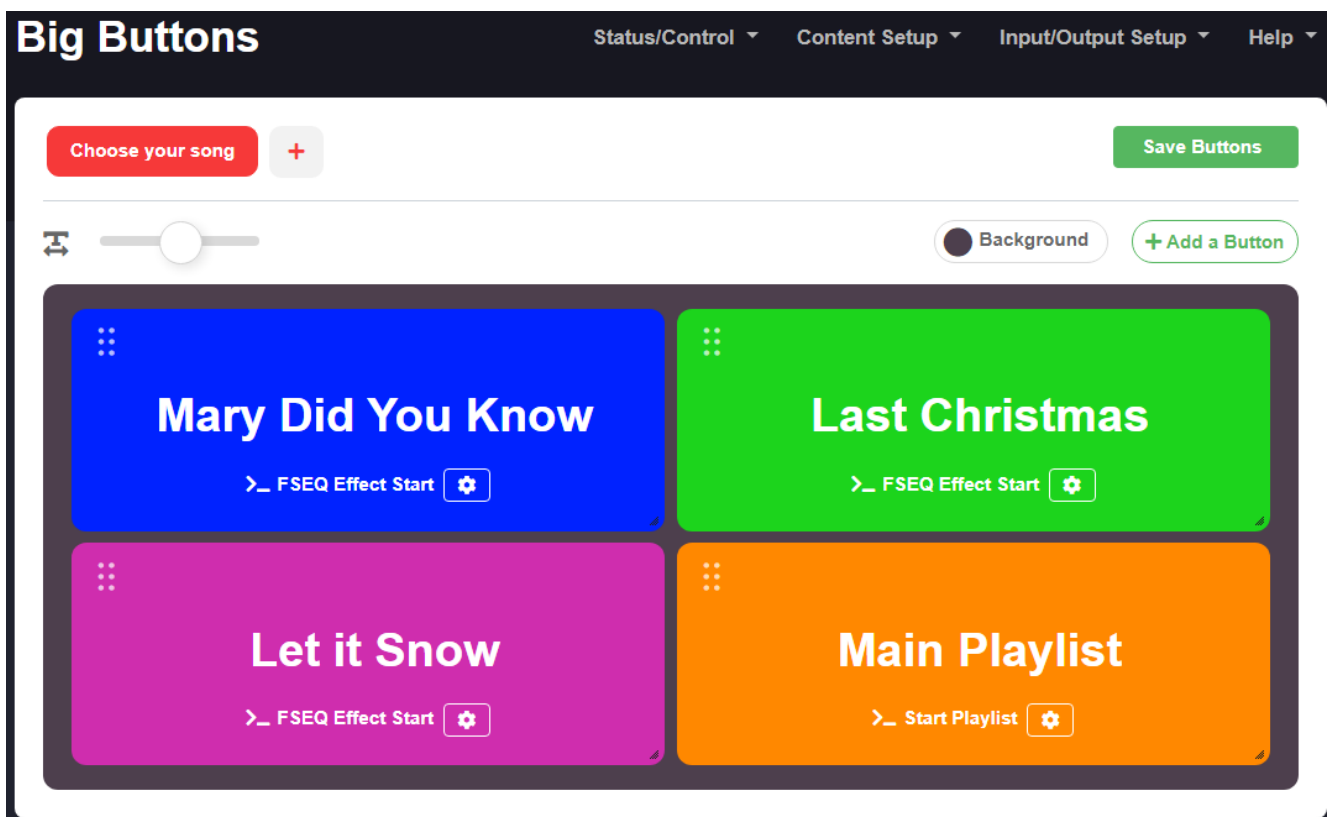

You can rearrange the buttons by dragging the button by the move selector (the six dots in the upper left corner of the button)

To load the page, go to the Status/Control section and select the Big Buttons Plugin

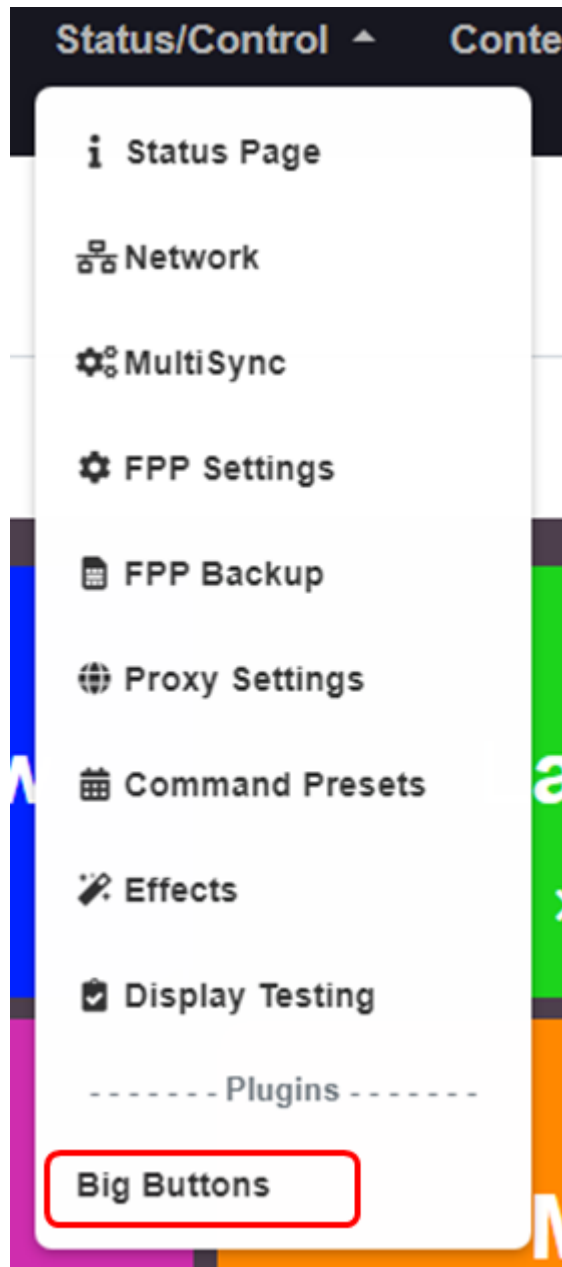

You will get a screen similar to this:

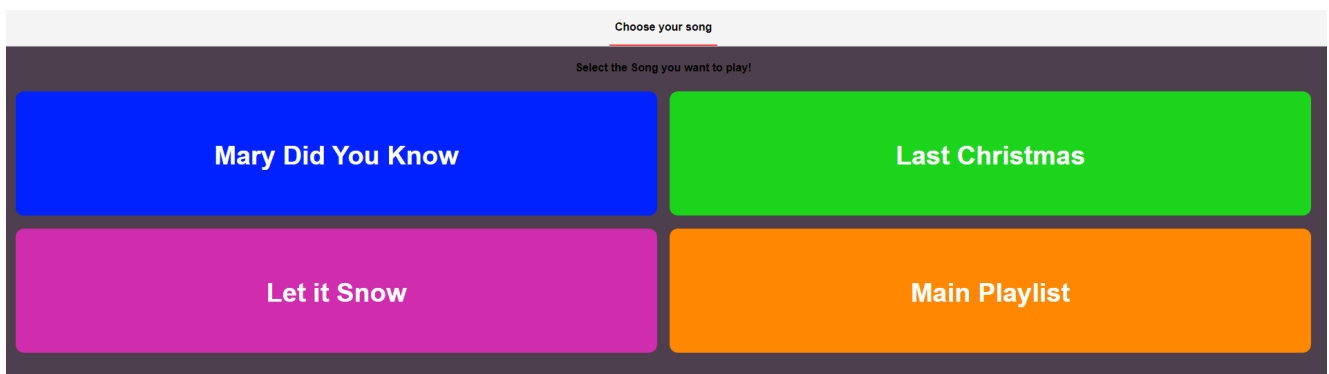

Clicking on the buttons will start the selected playlist. The buttons can control just about anything in FPP as long as they use FPP Commands and possibly scripts for more uncommon commands..

# Matrix Tools

The Matrix Tools Plugin will allow a user to display text and or draw on a matrix in real time. Other Plugins can use the Matrix Tools as well to draw on the matrix. To install the Matrix Tools Plugin, go to the Plugin Manager in the Content Setup section of FPP and click the Install button.

**MatrixTools**

AUTHOR: Chris Pinkham (CaptainMurdoch)

DESCRIPTION: This plugin uses FPP's Pixel Overlay feature to allow displaying dynamic text on a matrix and drawing on a matrix using your mouse in the web UI.

<https://github.com/FalconChristmas/fpp-matrixtools>

[View Source](#) [Report a Bug](#)

[Install](#)

In order to use the Matrix Tools, you need to create a Pixel Overlay Model for your matrix. Refer to the [Pixel Overlay Models](#) section for more information.. Make sure that the channel numbers are correct in the Channel Outputs>LED Panels and the Pixel Overlay model.

## LED Panels

Enable Led Panels:  Connection: Hat/Cap/Cape Wiring Pinout: PocketScroller

Matrix Size (WxH): 96x48 Start Channel: 16336

Single Panel Size (WxH): 32x16 1/8 Scan Channel Count: 13824(4608 Pixels)

Model Start Corner: Top Left Default Panel Color Order: RBG

Panel Gamma: 2.2

## Auto Created Pixel Overlay Models

MODEL NAME	START CH.	CH. COUNT	CH./NODE	ORIENTATION	START CORNER	STRINGS	STRANDS	RUNNING EFFECT
LED Panels	16336	13824	3	Horizontal	Top Left	48	1	

Once the Matrix tools are installed and you have the Pixel Overlay Model configured, you can open the Matrix Tools from the Status/Control section of FPP.

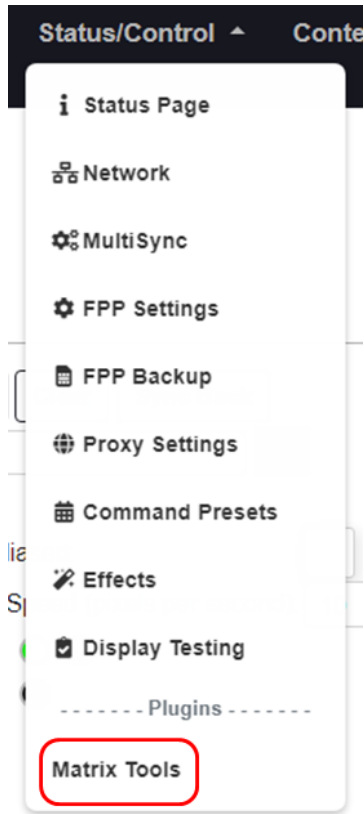

You will get a screen similar to this:

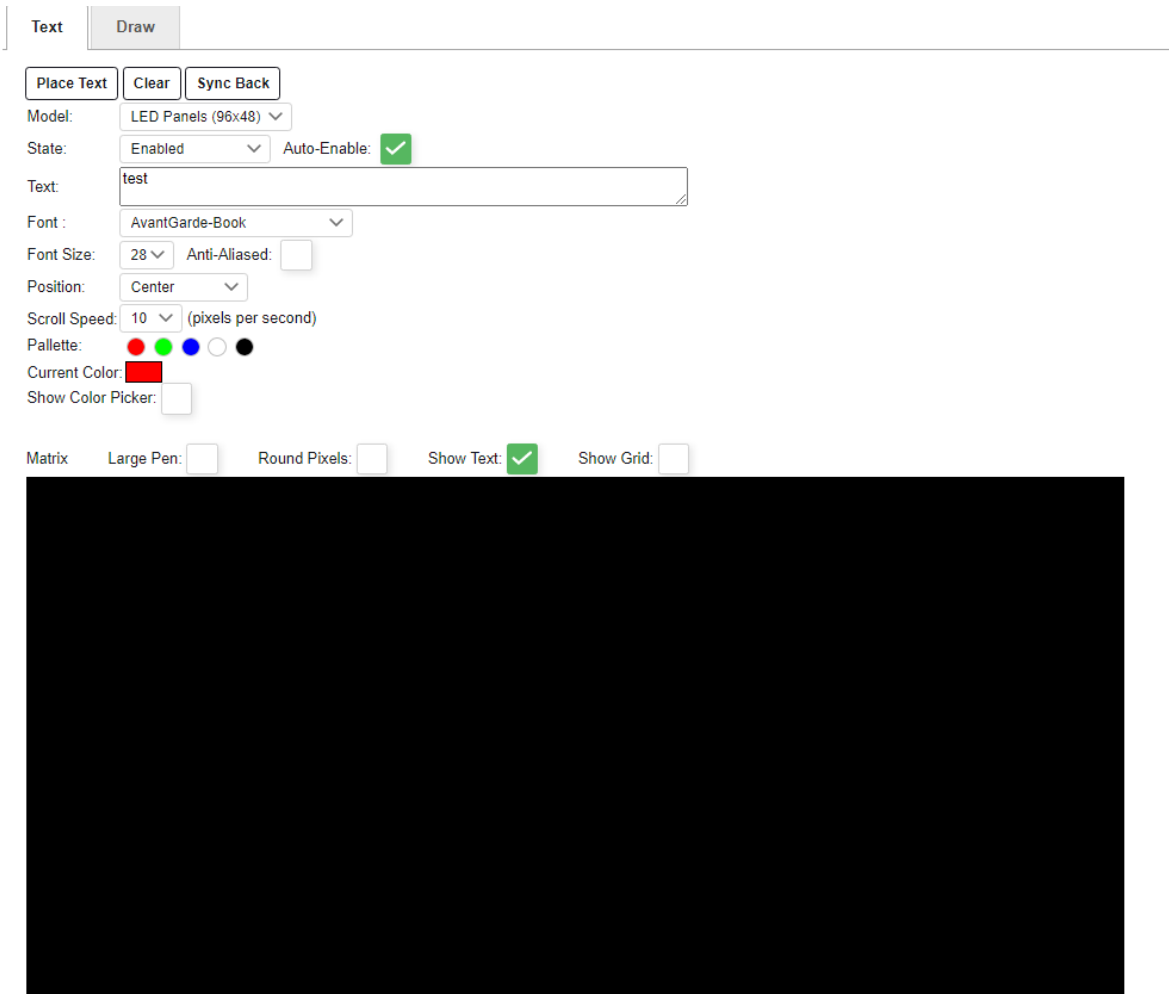

If you have more than one Pixel Overlay Model configured on this FPP then you will have to select the Pixel Overlay Model for your matrix in the first box. There are two tabs to use for the Matrix Tools, Text and Draw. Text allows you to type text and show that on the matrix with several options to display the text. The Draw tab allows you to directly draw on the matrix. You can have text displayed and draw on the Pixel Overlay Model.

At the top of the page there are three buttons:

Place Text- This will place the text in the Text box onto the display window of the web page, if the State is set to anything but Disabled, it will also display on your matrix (or whatever model you have configured)

Clear- This will clear the display window and your model.

Sync Back- This will synchronize the data that is displaying on your Pixel Overlay model, not just the Matrix Tools data. **This is not recommended as it is very CPU and web interface intensive and will slow everything down.**

Both tabs share but is only visible on the Text tab:

- Model- This will list all of your Pixel Overlay models; choose the model that you want to display the live data.
- State- There are four different states
  - Disabled- This is the inactive state for the Matrix tools
  - Enabled- This will stop all other data going to your Pixel Overlay Model and display only the data from the Matrix Tools.
  - Transparent- This will not stop other data coming into the Pixel Overlay Model and will display the Matrix Tools data at the same time. This will combine the channel data so will not display RGB colors correctly. This is only recommended for single color matrices.
  - Transparent RGB- This will not stop the other data coming into the Pixel Overlay model and any Matrix Tools data will override the other data being displayed and this is the recommended setting if you want to display the Matrix Tools data over the other incoming data.
- Auto Enable- With this enabled, your text or drawing will display when you click on the Place Text button.

The Text tab displays:

- Text- Type the text that you want to display.
- Font- Select the type of font that you want the text to display.
- Font Size- Select the size of the font for the text to display.
- Anti-Aliased- This will add shading to help eliminate the sharp edges.
- Position- You can select where you want the text to display, either centered, or scroll from left to right, right to left, bottom to top or top to bottom.
- Scroll Speed- Sets the speed at what the text will scroll if you select one of the scrolling options.
- Palette- You can select some of the basic colors which will in turn update the color picker to the palette color you selected.
- Current Color- This displays the current color that has been selected.
- Show Color Picker- You can select the color using various methods in the color picker. You can click in the Hue slider to get the approximate color and then select the exact shade in the main window, enter the RGB value or enter the hexadecimal value for the color.

Preview screen- This will show you an approximation of how your text is displaying. You can change the appearance on the Preview Screen to be round or square pixels, if it is a large pen and you can show a grid to indicate the positions of all the pixels.

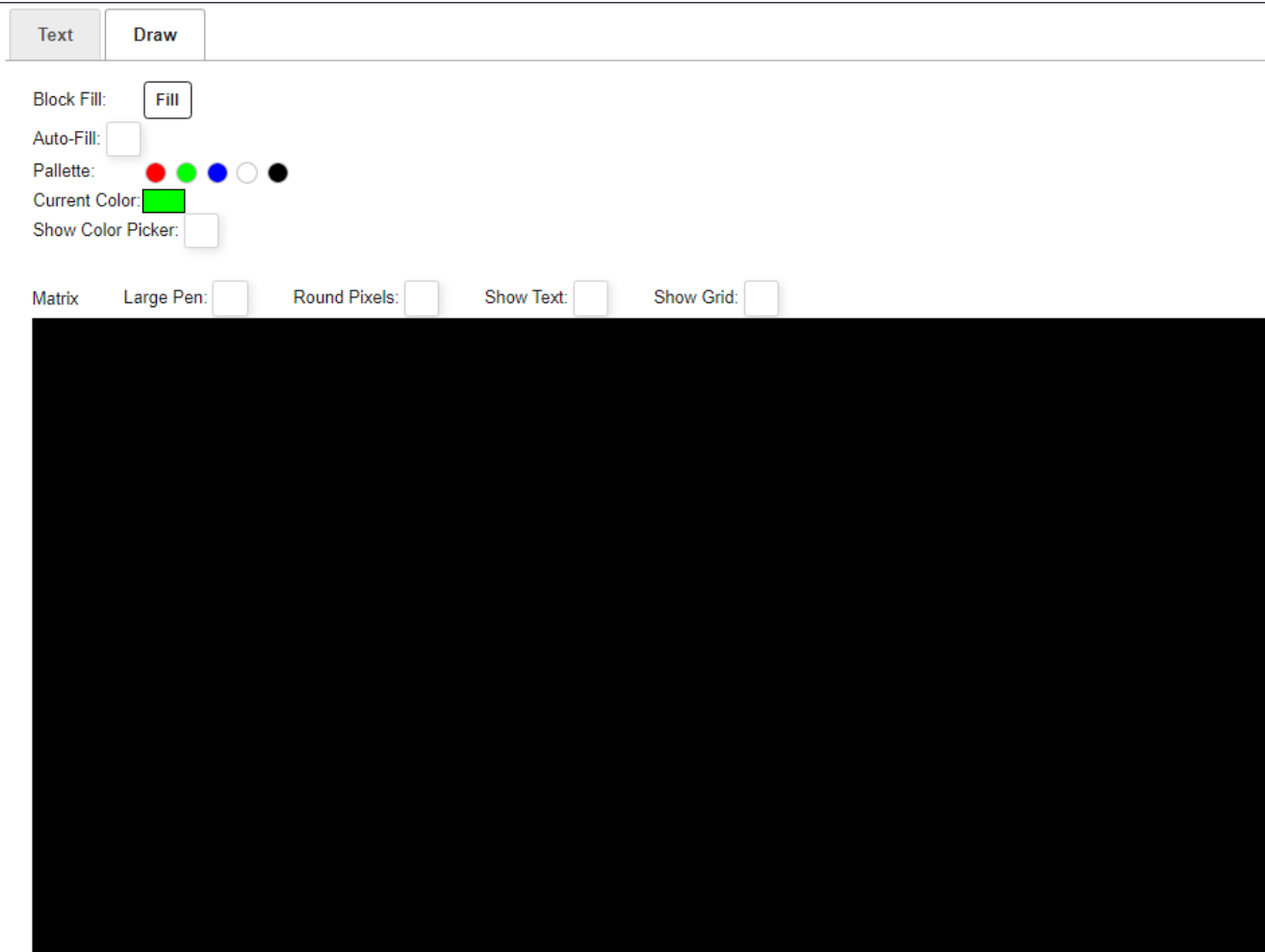

The draw tab displays:

- Block fill button that when clicked will fill the entire Model with the current color.
- Auto Fill- With this option enabled, any time you change the color, the screen will fill with the chosen color without having to click on the Fill Button.
- Palette- You can select some of the basic colors which will in turn update the color picker to the palette color you selected.
- Current Color- This displays the current color that has been selected.
- Show Color Picker- You can select the color using various methods in the color picker. You can click in the Hue slider to get the approximate color and then select the exact shade in the main window, enter the RGB value or enter the hexadecimal value for the color.

To draw on the Preview screen, left click and hold down the mouse button and draw your desired design.

## Message Queue Aggregator for Plugins

The Message Queue Aggregator for Plugins is a helper plugin used to store and manage messages from other Plugins. By itself it doesn't have much functionality but other plugins can send messages to this plugin to later display. To install the Message Queue Aggregator

for Plugins, go to the Plugin Manager in the Content Setup section of FPP and click the Install button.

<b>Message Queue Aggregator for Plugins</b>	AUTHOR: Ben Shaver (bshaver) and Pat Delaney (patdelaney)	DESCRIPTION: Message Queue Aggregator for Plugins	<a href="#">Install</a>
<a href="https://github.com/FalconChristmas/FPP-Plugin-MessageQueue">https://github.com/FalconChristmas/FPP-Plugin-MessageQueue</a>		<a href="#">View Source</a> <a href="#">Report a Bug</a>	

Once it is installed, you will have to go to the MessageQueue Plugin page from the Input/Output Setup section in FPP.

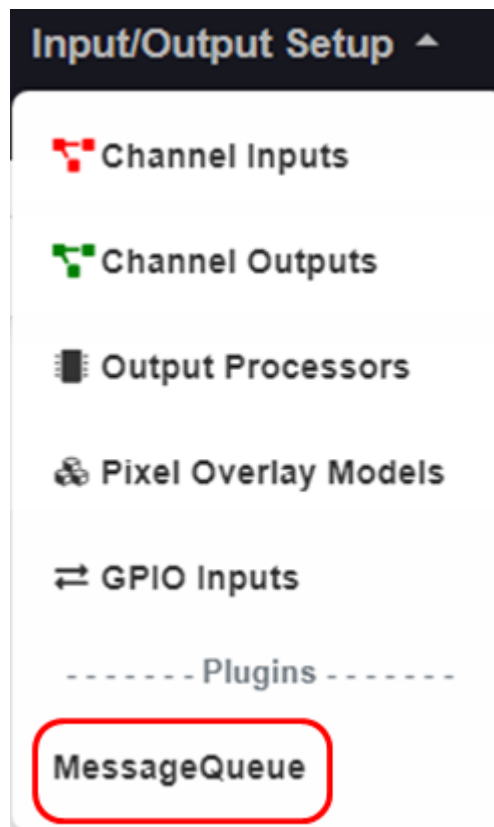

On this page you have to enable the plugin to activate it. You can manually delete any messages that are stored in the database from this page if you want. You can change the message database file path but it is not recommended to do so.



## FPP-Plugin-MessageQueue Version: 3.0 Support Instructions

Known Issues:

- NONE

Configuration:

- There is no configuration necessary. This plugin supports/allows plugins to communicate and share messages
- Current Plugins utilizing MessageQueue:
  - SMS Control
  - Matrix
  - SportsTicker
  - Weather
  - Election
  - Stock Ticker
  - RDS To Matrix
  - Event Date

To report a bug, please file it against the MessageQueue plugin project on Git: <https://github.com/FalconChristmas/FPP-Plugin-MessageQueue>

ENABLE PLUGIN:

Message File Path and Name (/home/fpp/media/config/FPP.FPP-Plugin-MessageQueue.db) :

Message file database

## Message Queue to Matrix Overlay

The Message Queue to Matrix Overlay Plugin is another helper plugin and it is used to read the messages in the Message Queue Aggregator Plugin and display the data when it is requested from another Plugin. To install the Message Queue to Matrix Overlay, go to the Plugin Manager in the Content Setup section of FPP and click the Install button.

<b>Message Queue to Matrix Overlay</b>	<b>AUTHOR:</b> Ben Shaver (bshaver) and Pat Delaney (patdelaney) updated by Rick Harris	<b>DESCRIPTION:</b> This plugin will push the messages that are in the Message queue plugin to your Matrix. This Plugin requires the Matrix Tools plugin and the Message Queue Aggregator Plugin	<input type="button" value="Install"/>
<a href="https://github.com/FalconChristmas/FPP-Plugin-Matrix-Message">https://github.com/FalconChristmas/FPP-Plugin-Matrix-Message</a>		<a href="#">View Source</a> <a href="#">Report a Bug</a>	

Once it is installed, you will have to go to the MatrixMessage Plugin page from the Input/Output Setup section in FPP.

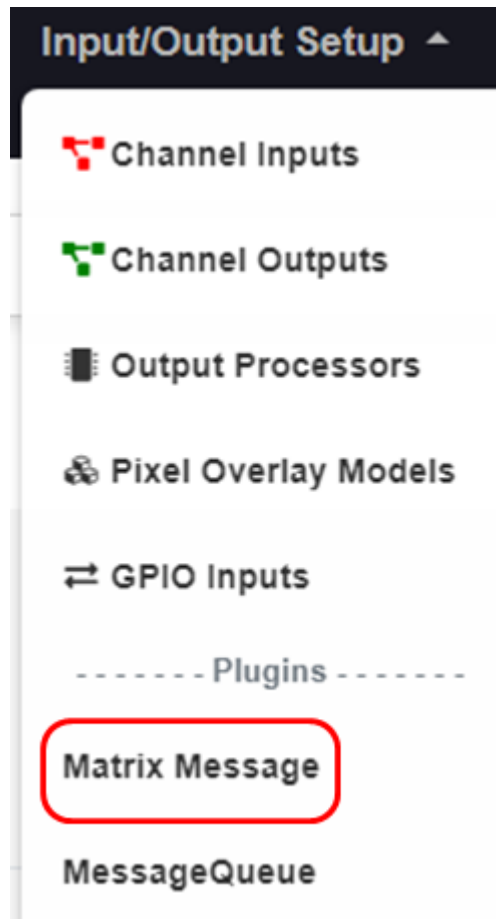

From this page, there are several configurations:

# FPP-Plugin-Matrix-Message Version: 3.0 Support Instructions

Known Issues:

- NONE

Configuration:

- This plugin allows you to use the fpp-matrixtools plugin to output messages from the MessageQueue system
- Select your plugins to output to your matrix below and click SAVE
- Configure your Matrix first before selecting here

ENABLE PLUGIN:

Matrix Name:

Overlay Mode:

**The Overlay mode determines how you want your message to display.**

- Full Overlay- This will blank out the model and only display your message
- Transparent- This will display your message over the top of whatever is displaying on your matrix but the colors will blend slightly with what is currently being displayed
- Transparent RGB- This will display your message over the top of whatever is displaying on your matrix the colors will override what is currently being displayed

Include Time:  Time Format:  Hour Format:

Plugins to use:

Font:  Font Size:  Anti-Aliased:  Scroll Speed:

Duration:

If you set the scroll speed to 0, then the message will display on the center of the matrix for the number of seconds set in the Duration

Palette:

Current Color:

Show Color Picker:

To report a bug, please file it against <https://github.com/FalconChristmas/FPP-Plugin-Matrix-Message.git>

You need to configure the following settings:

- Enable Plugin- This needs to be checked to make the plugin active.
- Matrix Name- This is the Pixel Overlay Model that is your matrix.

- **Overlay Mode-** This is the setting from the Matrix tools on how to display the message. Select the number that corresponds to the effect you want. Full Overlay is the most common.
  - Full Overlay will block all other data being sent to the matrix.
  - Transparent will not stop other data coming into the Pixel Overlay Model and will display the Matrix Tools data at the same time. This will combine the channel data so will not display RGB colors correctly. This is only recommended for single color matrices.
  - Transparent RGB will not stop the other data coming into the Pixel Overlay model and any Matrix Tools data will override the other data being displayed and this is the recommended setting if you want to display the Matrix Tools data over the other incoming data.
- **Include Time-** If this box is checked, the time will display when the messages are displayed, it will include the current system time so make sure you have an NTP or Real Time Clock configured.
  - Time Format- This lets you select the Time Format used if the time is displayed.
  - Hour Format- This lets you select from a 24 hour or AM/PM style time.
- **Plugins to use-** Select the plugins that are sending information to the Message Queue and that you want to display on your matrix. To select more than one plugin, hold down the Ctrl key and click each additional plugin that you want to manage.
- **Font-** Sets the font style that you want to display.
- **Font Size-** Sets the font size that you want to display.
- **Anti-aliased-** Will try to eliminate the jaggy edges on some fonts by applying shading.
- **Scroll Speed-** The speed that the message will scroll across the matrix.
- **Duration-** If you set the scroll speed to 0, then the message will display in the center of the screen for the number of seconds configured for your Duration.
- **Palette-** You can select some of the basic colors which will in turn update the color picker to the palette color you selected.
- **Current Color-** This displays the current color that has been selected.
- **Show Color Picker-** You can select the color using various methods in the color picker. You can click in the Hue slider to get the approximate color and then select the exact shade in the main window, enter the RGB value or enter the hexadecimal value for the color.

## Event Date

The Event Date Plugin will allow your matrix to display a dynamic countdown to a particular event. You can have other text included with the countdown if you desire. The Event Date Plugin needs 3 other plugins installed and configured in order to work correctly.

- Message Queue to Matrix Overlay
- Message Queue Aggregator for Plugins
- Matrix Tools

To install the Event Date Plugin, go to the Plugin Manager in the Content Setup section of FPP and click the download button.

<b>Event Date</b>	<b>AUTHOR:</b> Ben Shaver (bshaver) and Steve Smock updated by Rick Harris	<b>DESCRIPTION:</b> This plugin will give you a countdown to a specified date	<a href="#">Install</a>
<a href="https://github.com/FalconChristmas/FPP-Plugin-EventDate">https://github.com/FalconChristmas/FPP-Plugin-EventDate</a>		<a href="#">View Source</a> <a href="#">Report a Bug</a>	

Once it is installed, you will have to go to the Event Date Plugin page from the Input/Output Setup section in FPP.

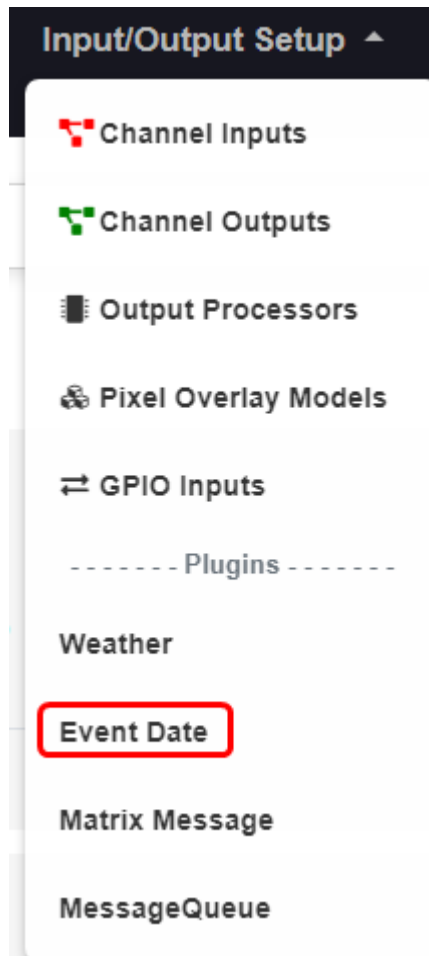

You need to configure the following settings:

## FPP-Plugin-EventDate Version: 3.0 Support Instructions

Known Issues:

- None

Configuration:

- Configure the date and time of your event
- Enter in the PRE TEXT that will appear before your countdown
- Configure 12 or 24 hour countdown mode
- Schedule the event in your Playlist to send the countdown out your Matrix

This plugin requires ACCURATE time for its calculation.

ENABLE PLUGIN:

Event Name:

Event Date:    Hour:  Min:

Pre Text:

Post Text:

If the remaining time is more than a day then you can select to include the hours and/or minutes.

If the remaining time is less than a day, the plugin will automatically display the hours and minutes remaining.

Include Hours:

Include Minutes:

Your message will appear as:

**It is 139 days until Christmas**

If you want your message to display immediately when the command to run the countdown is activated then enable the Immediate Output. Otherwise the message will be stored in the Matrix Message Queue until you give the Matrix Message Queue the command to run.

Immediately output to Matrix (Run MATRIX plugin):

The Matrix message Plugin location should be the default of 127.0.0.1 unless you have a specialized installation configuration.

MATRIX Message Plugin Location:

To report a bug, please file it against the sms Control plugin project on Git: <https://github.com/FalconChristmas/FPP-Plugin-EventDate.git>

You need to configure the following settings:

- Enable Plugin- This needs to be checked to enable the plugin.
- Event Name- Enter the name of the event that you are counting down.
- Event Date- Enter the date of the event.
- Pre Text- Enter the text that you want to display before the countdown date.
- Post Text- Enter the text that you want to display after the countdown date.
- If Remaining time  $\geq$  1 day include.
  - Include Hours-
  - Include Minutes-

On the last day, the countdown will display the hours and minutes to the event, you can include the hours and minutes for the entire countdown by checking either of these boxes.

- Your message will appear as- This shows how the display will look.
- Immediately output to Matrix- If this box is checked, anytime the EventDate plugin is triggered, the message will be displayed on the matrix. If it is not checked, then the EventDate data will be stored until it is displayed using the RUN-MATRIX.sh script.
- Matrix Message Plugin Location- By default the IP address is 127.0.0.1 which is the loopback address of the Pi and should not be changed unless you are using some advanced configurations.
- Save Config- This will save the changes that you have made to the Plugin.

To use the EventDate Plugin you have to run the Run Event Date FPP Command. This can be run in any of the ways that FPP Command can be run such as a Playlist item. If you want it to play at the time you have it activated in your playlist, make sure that you have the “Immediately Output to Matrix” checked.

## Weather Information

The Weather Information Plugin will allow your matrix to display the current weather for your location or any other location you choose such as the North Pole. The Weather Information Plugin needs 3 other plugins installed and configured in order to work correctly and you will need to get an API key from [https://home.openweathermap.org/users/sign\\_up](https://home.openweathermap.org/users/sign_up). The plugins you will need are:

- Message Queue to Matrix Overlay
- Message Queue Aggregator for Plugins
- Matrix Tools

To install the Weather Information, go to the Plugin Manager in the Content Setup section of FPP and click the download button.

Once it is installed, you will have to go to the Weather Information Plugin page from the Input/Output Setup section in FPP.

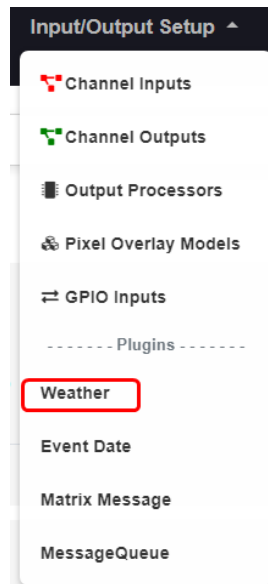

You need to configure the following settings:



## FPP-Plugin-Weather Support Instructions

Known Issues:

- None

Configuration:

- Configure your City & 2 Character State & Separator Character to display
- Not all City and State combinations are supported. If not, you can select the Other Country option and use your Latitude and Longitude settings to get your local weather.

Link to settings: [System tab](#)

- Visit <http://home.openweathermap.org/> to sign up for an API KEY

ENABLE PLUGIN:

Pre Text (Text to display ahead of Weather data):

Post Text (Text to display after weather data):

Select your country  US  Other

**Make sure your Latitude and Longitude settings are correct. To change them, go to the FPP Settings page on the [System tab](#)**

Latitude:

Longitude:

Temperature type:

Include Locale in output:

Separator:

Include Temp:

Include Wind:

Include Humidity:

Include Degree Symbol (°):

API KEY:

Immediately output to Matrix (Run MATRIX plugin):

**If you want your message to display immediately when the command to run the Weather is activated then enable the Immediate Output. Otherwise the message will be stored in the Matrix Message Queue until you give the Matrix Message Queue the command to run and your data won't be current**

To report a bug, please file it against the project on Git: <https://github.com/FaloonChristmas/FPP-Plugin-Weather>

- Enable Plugin- This needs to be checked to enable the plugin.
- Pre Text- Enter the text that you want to display before the temperature data.
- Post Text- Enter the text that you want to display after the temperature data.
- Select your Country- Select the US (United States) if you want to enter your location by city and state and select Other if you are not in the US or need to enter the Latitude and Longitude of your coordinates. If you select Other, then you need to configure your location in the FPP Settings>System tab. (When you go to that tab, there will be coordinates displayed, but they are not actually saved, you will need to enter your actual coordinates.)

- City- Enter the city that you want the weather to be displayed.
- State- Enter the 2 digit abbreviation for your state.
- Temperature Type- Select the temperature type that you want the data to display in, either Fahrenheit or Celsius.
- Include Locale in Output- This will include the City and State in the output.
- Separator- If you want a separator symbol in between the fields, such as an | you can select one.
- Include Temp- Select this if you want the temperature to display.
- Include Wind- Select this if you want the Wind data to display.
- Include Humidity-Select this if you want the Humidity to display.
- Include Degree Symbol- Select this If you want the degree symbol to display with the temperature.
- API KEY- enter the API key that you received from <https://home.openweathermap.org>
- Immediately output to Matrix- If this box is checked, anytime the Weather Information plugin is triggered, the message will be displayed on the matrix. If it is not checked, then the Weather Information data will be stored until it is displayed using the RUN-MATRIX.sh script. It is recommended to have this checked.
- Save Config- This will save the changes that you have made to the Plugin.
- Update Plugin- This will check for updates to the Plugin and install them.

The output will be in this format (only the options selected will display):  
 “Pre text” + “Locale”+ “Temp” + “degree symbol”+ “Wind” + “Humidity” + “Post Text

So if your Pre Text is “It is now”, your Post Text is “in Falcon Colorado” and you selected the Include Temp, Include Wind, and Include Degree Symbol, the output would look like this:

It is now Temp: 62.4° Wind: W 5 MPH in Falcon Colorado

You will need to configure the Matrix Message Plugin to process messages from the Weather Plugin by including it in the output options.

To use the Weather Plugin you have to run the Run Weather Plugin FPP Command. This can be run in any of the ways that FPP Command can be run such as a Playlist item. If you want it to play at the time you have it activated in your playlist, make sure that you have the “Immediately Output to Matrix” checked.

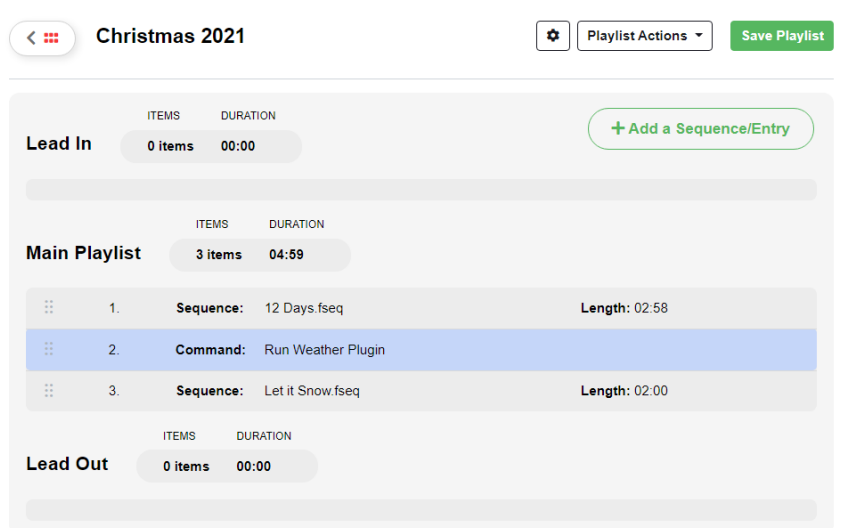

# Projector Control

If you use a Projector in your display and it supports controlling remotely through a serial or Ethernet port. If your projector uses a serial port for remote control, then you will need a USB to Serial adapter.

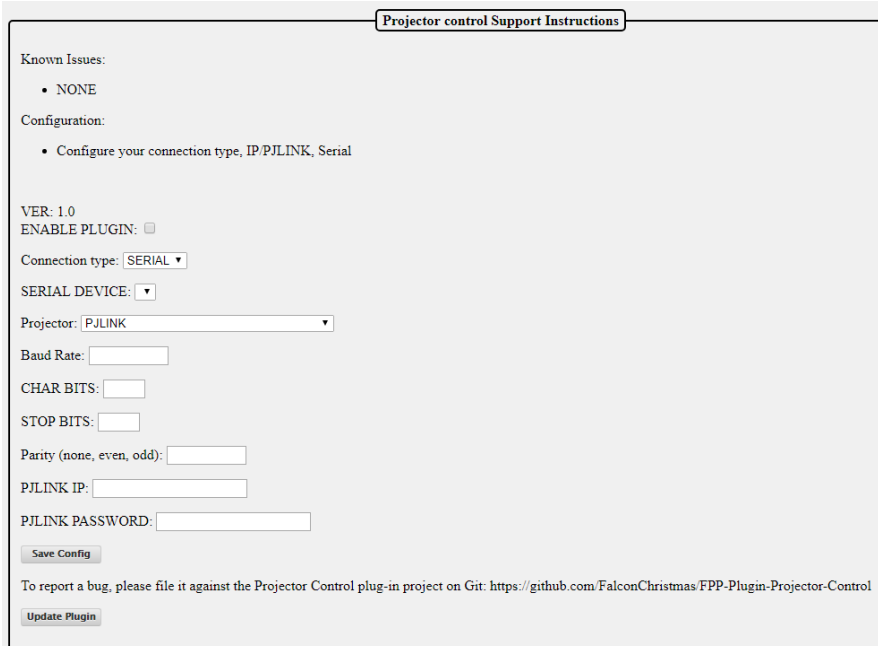

The screenshot shows a dialog box titled "Projector control Support Instructions". It contains the following sections:

- Known Issues:**
  - NONE
- Configuration:**
  - Configure your connection type, IP/PJLINK, Serial
- VER: 1.0
- ENABLE PLUGIN:
- Connection type: SERIAL (dropdown menu)
- SERIAL DEVICE: (dropdown menu)
- Projector: PJLINK (dropdown menu)
- Baud Rate: (text input)
- CHAR BITS: (text input)
- STOP BITS: (text input)
- Parity (none, even, odd): (text input)
- PJLINK IP: (text input)
- PJLINK PASSWORD: (text input)
- Save Config (button)
- To report a bug, please file it against the Projector Control plug-in project on Git: <https://github.com/FalconChristmas/FPP-Plugin-Projector-Control>
- Update Plugin (button)

You will need to configure the plugin for the projector you are using; this information is usually available in the user manual for your projector.

- Enable Plugin- check this box to enable the plugin.
- Connection type- Select the connection type that you are going to use for your communication.
- Serial Device- If your connection type is Serial, you will have to select the Serial device that you are going to use. (normally you will only have one Serial device to select from)
- Projector- Many projectors support the PJLINK protocol, if your projector supports PJLINK you can select that, if not then select your projector from the drop down list.
- Baud Rate- Enter the Baud Rate that your projector utilizes. (9600 and 19200 are the most common.)
- CHAR BITS- Enter the CHAR BITS (the most common is 8).
- STOP BITS- Enter the STOP BITS (the most common is 1).
- Parity- Enter the Parity value (the most common is none).
- PJLINK IP- Enter the PJLINK IP address for your projector.
- PJLINK Password- Enter the PJLINK Password for your projector (if there is one).

After entering your information, click on the Save button.

The Projector Control plugin will generate several Events and Scripts that you can use to control your projector.

# Plugin Development

If you want to develop a plugin there is documentation at [https://github.com/FalconChristmas/fpp/blob/master/docs/Plugin\\_Development.md](https://github.com/FalconChristmas/fpp/blob/master/docs/Plugin_Development.md) and you can also go to the Plugin Manager in the Content Setup section of FPP.

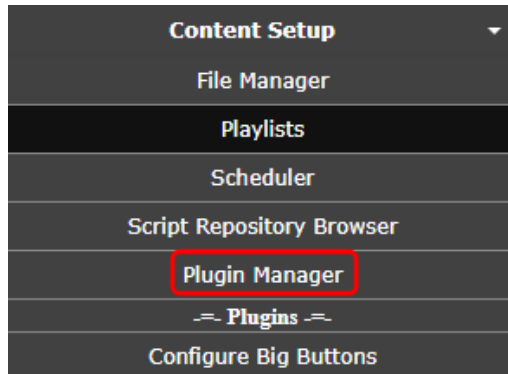

On this page is a Plugin template that has a shell for all the components that you will need to incorporate a plugin into FPP.

## Template Plugin

### Template Plugin for FPP Plugin developers

This template plugin is designed to make it easier for plugin authors to create new FPP Plugins. You can manually clone the git repository or install the Template Plugin and then go to the plugin's config page and use the form to copy the template into a new plugin directory.  
By: John Doe (jdoe)

The best method is to go to the website for the template and clone the files into a GitHub repository of your own. Clicking on the Source Code or Home buttons will take you to the GitHub repository for the Template Plugin.

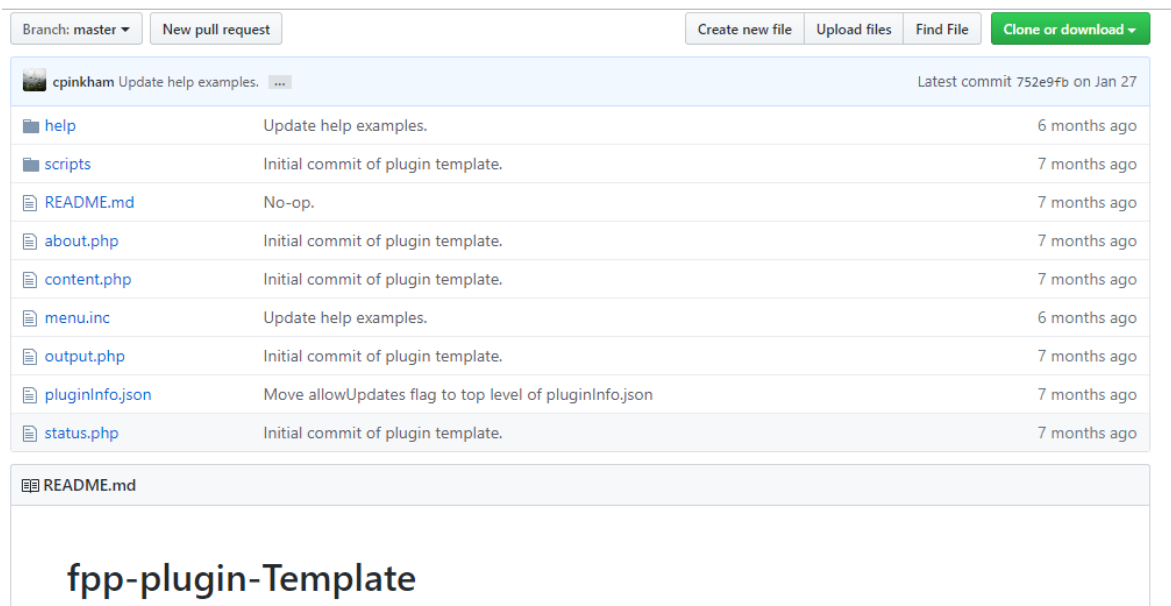

The template has the following files and it is recommended to follow this file structure:

- Help- This is a folder to hold the relevant help files for your plugin and it is highly recommended to document the installation, configuration and operation of your plugin. The Help files will be available to the user when they hit the F1 key or click the “Press F1 for Help” link at the top of your page. The file name for your Help file needs to match the file name for the page it is related to, but you are not limited to the suggested files. You can have pages with a different file name, you will need to include a matching help file with the same file name. The Help folder has the following files and if you don't have a page with a matching name, then you can (not mandatory) delete the file.
  - content.php- This will have the help information, formatted in html, for your content.php file in the main directory.
  - help.php- This will have the help information, formatted in html, for your help.php file in the main directory.
  - output.php- This will have the help information, formatted in html, for your output.php file in the main directory.
  - status.php- This will have the help information, formatted in html, for your status.php file in the main directory.
- Scripts- This is a folder to hold scripts needed for your Plugin. There are some scripts that will run automatically at the appropriate time. These do not get saved in the Script folder in FPP. If there are scripts that the user will need to use, the Plugin author will need to copy those scripts into the FPP scripts folder, usually this can be accomplished by adding the copy routine in the fpp\_install.sh file. The Scripts that run automatically are:
  - fpp\_install.sh- This script will run when the user installs the plugin. If there are any special requirements for your plugin such as scripts or other files to be copied in the correct place, this might be the place to perform those functions.
  - fpp\_uninstall.sh- This script will run when the user uninstalls the plugin. If you created any special files and they are not needed for any other application, then you can delete these and perform any other cleanup functions in this script.
  - postStart.sh- This script will run after fppd starts. If your plugin needs any processes to run prior to the user accessing your plugin, this is where you should put these functions.
  - postStop.sh- This script will run after fppd stops and can be used for any cleanup processes.
  - preStart.sh- This script will run right before fppd starts.
  - preStop.sh- This script will run right before fppd stops.
- README.md- This file is used to display relevant information in regards to your plugin and will be displayed in the GitHub main page for your plugin. If your plugin requires another plugin to function, you might want to include it here as well.
- about.php- If you want to have an about informational page for your plugin, then you can use this template to display your about webpage. You will need to provide a link to it.
- content.php- This is a placeholder file for demonstration purposes. You can name your plugin file(s) anything you want, just make sure you link them properly in the menu.inc file.
- menu.inc- This file is used to provide navigation items for your plugin. If you use the menu.inc file, then you need to specifically identify the various tabs on the menu that you want to use. This can be helpful if you want to create all of your menu items in one

file. If you don't specifically create the menu items in this file then your plugin page will show under EVERY menu item. The template file has an explanation and example.

- output.php- This is a placeholder file for demonstration purposes. You can name your plugin file(s) anything you want, just make sure you link them properly in the menu.inc file.
- pluginInfo.json- This is a required file.
- status.php- This is a placeholder file for demonstration purposes. You can name your plugin file(s) anything you want, just make sure you link them properly in the menu.inc file.

Once your plugin has been created, you can load your plugin by following the instructions for Retrieving Plugin Info in the Plugin page. If you would like to have your plugin available to other users, post the information in the Plugin section of the Falcon Christmas forum and if approved, a link will be added to the Available Plugins section.

# Resources

## Help

There are several resources available for help, here are a few of the more popular help resources are:

<http://falconchristmas.com/forum/> -This forum is very active and you can usually get a response fairly quickly.

<http://auschristmaslighting.com/forums/> -This forum is also very active and you can usually get a response fairly quickly. You don't have to be from Australia to post here.

<https://auschristmaslighting.com/> - This is the parent site for the auschristmaslighting forums and there are several resources there, one that is a must have is the AUSManual101.pdf. You need to register it in order to download the manual.

<http://www.xLights.org> This website has links to several resources including a forum. The information is geared towards xLights users but it is not exclusively xLights.

<http://videos.xLights.org/> -This website has several videos on all aspects of the Holiday Lighting hobby.

<https://www.youtube.com/channel/UCby1v6Kbi8AHMkV2yMyF1MQ/featured> - This is the Canispater Christmas YouTube channel and there are many very informational videos.

<https://zoom.us/j/175801909?pwd=ZU1hNzM5bjJpOGZ1d1BOb1BzMUFndz09> - This website will take you to a live video conference site. They have xEssential training classes every Wednesday at 8:00 PM Eastern time, but there is usually someone there most of the time and is a good way to get instant help. You will have to install the software the first time you go to the website.

## Configuring a Static Route

If your network configuration is utilizing more than one subnet, then you will probably need to configure a Static Route. This can be accomplished in a few different methods and depends on the operating system you are using.

The examples below assume that your home/show router has an IP address of 192.168.0.1 and you are connecting your FPP to your home/show network via Wi-Fi and to your controller via Ethernet. Your controller needs to have an IP on a different subnet than your home/show network, for this example we will use 192.168.101.2. The FPP will need an IP address on the wlan0 interface in the same network as the home/show router, we will use 192.168.0.101 and it will need an IP address on the eth0 interface in the same subnet as the controller, we will use 192.168.101.1

Static Routing in router- Not all routers support static routing but most of them do and this is the preferred method. By adding a static route in your router, all devices connected to your network will have access to your controllers. Due to the large number of router manufacturers and the interfaces they use, the method could be different. The Static Routing is usually in an advanced section of the router and called Routing, Advanced Routing, Static Routing, etc. They will be similar to this:

## Static Routing

[+ Add](#) [- Delete](#)

<input type="checkbox"/>	ID	Network Destination	Subnet Mask	Default Gateway	Interface	Description	Status	Modify
<input type="checkbox"/>	--	--	--	--	--	--	--	--

Network Destination:

Subnet Mask:

Default Gateway:

Interface:

Description:

Enable This Entry

[Cancel](#) [Save](#)

- Network Destination- Enter the subnet of your controller, in this case it will be 192.168.101.0 (note the last number is 0 and NOT the address of the controller.)
- Subnet Mask- Enter 255.255.255.0
- Default Gateway- Enter the IP address of the wlan0 interface on the connected FPP, in this case it will be 192.168.0.101.
- Interface- This option might not be available, use LAN if it is an option.
- Description- This option might not be available. If it is, then enter a description about this route.

Static Routing in Computer - You can enter a static route into your computer. By adding a static route in your computer, only that computer will have access to your controllers. You can add a static route to more than one computer if needed. Windows and Mac computers have different methods.

- Windows- Open a command prompt window (as an administrator) and based on the example given enter:  
`route -p add 192.168.101.0 mask 255.255.255.0 192.168.0.101`
- Mac- Open a Terminal window and based on the example given enter:  
`sudo route add 192.168.101.0/24 192.168.0.101`  
(Note: The route add function in Macs are not persistent so if the computer is turned off or rebooted, the route will need to be added again)

Creating a Proxy Host- You can use an FPP device to route network traffic between subnets by setting the FPP as a Proxy Host. This can be useful if you are unable to create a static route in your router and using a Mac computer (since the Mac doesn't support persistent routes.) You can use a Proxy Host with Windows computers as well. See [Proxy Settings](#) for more information.



# FPP Connect

The FPP Connect function in xLights is probably the best and most efficient method to upload your sequences and media files to all of the FPP devices that need them. It can also be used to configure most of the settings in FPP for your port outputs. You can upload to one, all, or selected FPP devices in one step which greatly simplifies the process of updating your show data.

## FPP Connect in Windows

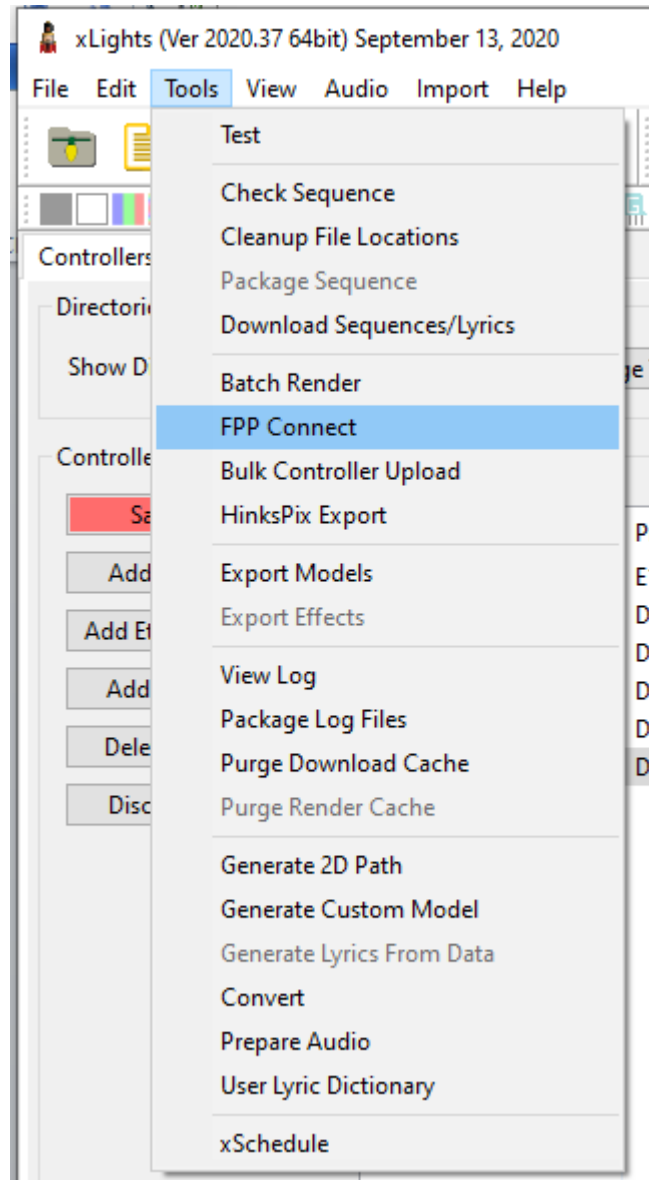

## FPP Connect in a Mac

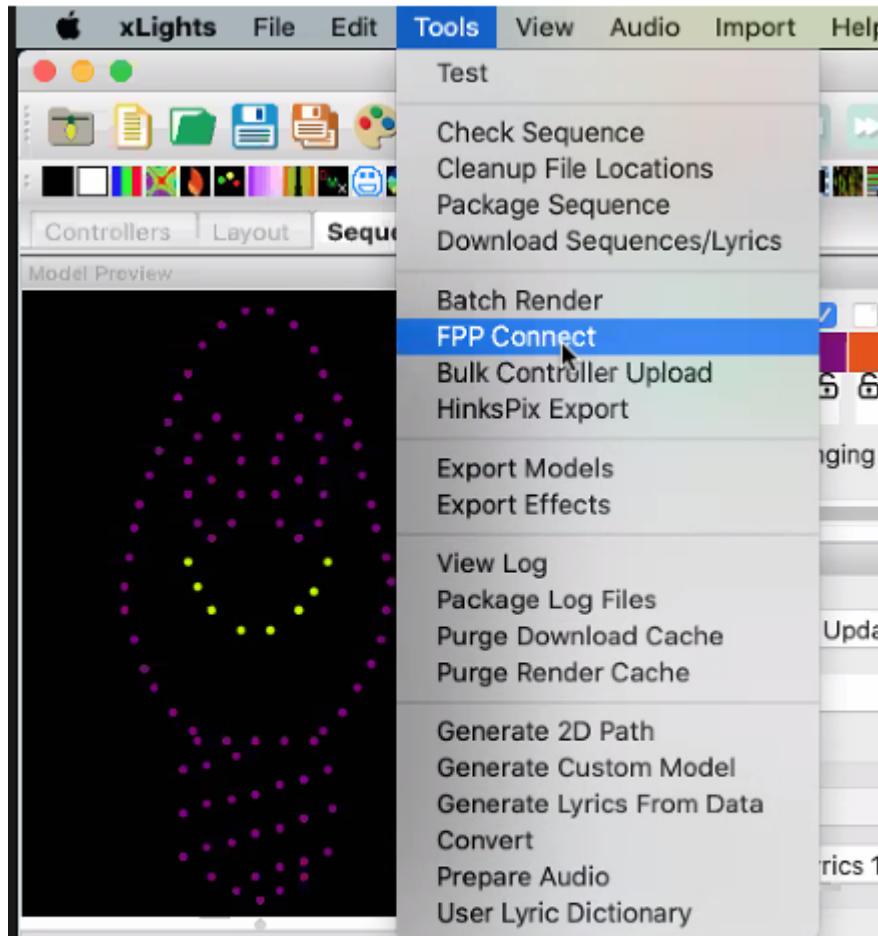

Once you open FPP Connect, it will discover all of the FPP devices in your system.

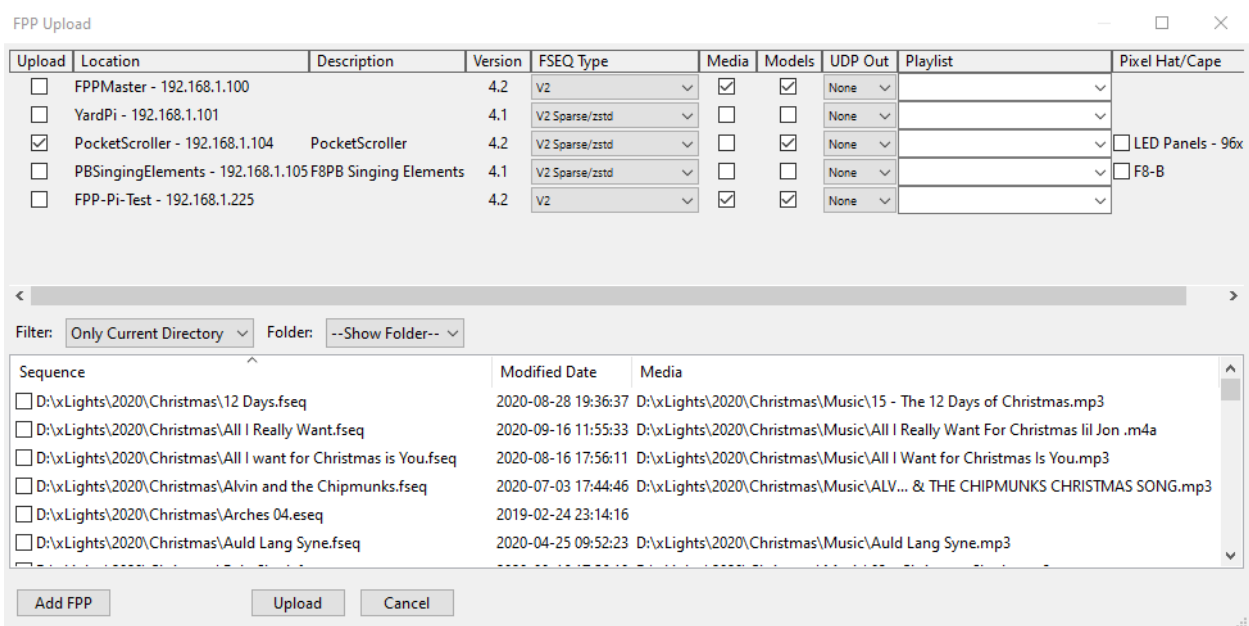

If one of your FPP devices does not show up in the list, you can manually add it by clicking on the Add FPP button and add the FPP address for the FPP device you want to discover.

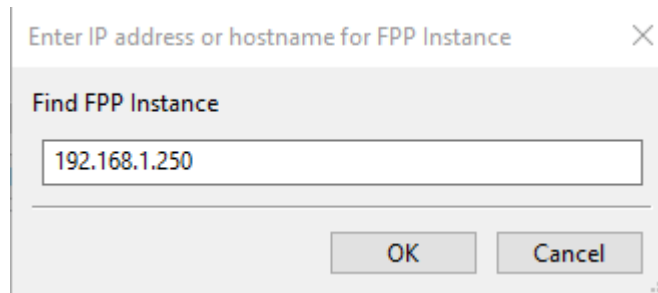

Many times the reason for not discovering an FPP device is because you have more than one device with the same Host Name (like FPP) or a network configuration issue. There are many options in the FPP Connect that provide a lot of functionality.

Upload	Location	Description	Version	FSEQ Type	Media	Models	UDP Out	Playlist	Pixel Hat/Cape
<input type="checkbox"/>	FPPMaster - 192.168.1.100		4.2	V2	<input checked="" type="checkbox"/>	<input checked="" type="checkbox"/>	None		
<input type="checkbox"/>	YardPi - 192.168.1.101		4.1	V2 Sparse/zstd	<input type="checkbox"/>	<input type="checkbox"/>	None		
<input checked="" type="checkbox"/>	PocketScroller - 192.168.1.104	PocketScroller	4.2	V2 Sparse/zstd	<input type="checkbox"/>	<input checked="" type="checkbox"/>	None		<input type="checkbox"/> LED Panels - 96x
<input type="checkbox"/>	PBSingingElements - 192.168.1.105	F8PB Singing Elements	4.1	V2 Sparse/zstd	<input type="checkbox"/>	<input checked="" type="checkbox"/>	None		<input type="checkbox"/> F8-B
<input type="checkbox"/>	FPP-Pi-Test - 192.168.1.225		4.2	V2	<input checked="" type="checkbox"/>	<input checked="" type="checkbox"/>	None		

**Upload-** This checkbox is to select which FPP devices you want to take action on. Whatever choices you select will apply to all of the FPP devices checked in this column.

**Location-** This is the HostName and IP address of your FPP devices (this is for information only).

**Description-** This is the Description that you entered in FPP to provide additional information to give more complete details about the FPP Device (this is for information only).

**Version-** This will show the FPP version that the FPP device is using. (this is for information only).

**FSEQ Type-** This is the format of the FSEQ file that you are going to upload. The formats are:

- V1- This is an older format and is quite a bit larger than the V2 format. This is typically only used for old versions of FPP.
- V2- This is a compressed version and more efficient than the V1 version. The V2 version will contain all of the channel data in the sequence.
- V2 Sparse/zstd- This is a compressed format but will be customized for the associated FPP device to only contain the channels this device needs which saves a lot of space.
- V2 Sparse/zstd Uncompressed- This is a V2 format that will be customized for the associated FPP device to only contain the channels this device needs which saves a lot of space but won't be compressed for controllers that cannot handle compression (this is not very common).

**Media-** If this box is checked, FPP Connect will upload the Media (.mp3/.mp4) that was used for the sequence as noted in the Media section of the File Selection box at the bottom portion of the screen to the FPP device on that same line.

**Models-** If this box is checked, FPP Connect will upload the Model Data (channels, positions, configurations, etc.) from your show layout and store them as Pixel Overlay Models to the FPP device on that same line. This can be useful if you want to test controllers by Model and required if you are going to use a Virtual Display or HTTPVirtual Display.

**UDP Out-** This option is used to configure and enable the E1.31/DDP outputs. The options are:

- None- This is used for devices that do not need to output E1.31/DDP data such as Cape type controllers or FPP devices running in Master mode.

- All- This will upload and enable all of the E1.31/DDP Output channels configured in xLights. Many times you will not need all of the E1.31/DDP channels configured so you will have to delete or make inactive the channels your FPP device does not need to send out. A main player that is outputting the show data to a switch that is connected to all of your controllers will need all of the E1.31/DDP channels configured.
- Proxied- This will only upload and enable the E1.31/DDP channels that are configured for the controller that is attached to this FPP device AND the FPP device is configured as a Proxy Host for that controller.

Playlist- If you are uploading sequences to an FPP device and want to ADD it to an existing playlist, you can select the playlist that you want them added to. All the sequences selected will be ADDED to the playlist. **If you already have the sequence in the playlist, this will still add it to the playlist and you will have the sequence(s) in your playlist twice.**

Pixel Hat/Cape- If your FPP device has a hat or cape and configured for local pixel ports, then this option will be available and if checked will upload the pixel port configuration to the controller.

## GPIO Button Input

You can use one of the available GPIO buttons to trigger an event. In order to do so, you will need to identify which pins are actually GPIO pins. Here are the pinout diagrams of the more common SBCs used. Make sure you confirm the GPIO pins of the SBC you are using before making your connections and always make connections with the power disconnected.

Raspberry Pi 3 GPIO Header

Pin#	NAME		NAME	Pin#
01	3.3v DC Power		DC Power 5v	02
03	GPIO02 (SDA1 , I2C)		DC Power 5v	04
05	GPIO03 (SCL1 , I2C)		Ground	06
07	GPIO04 (GPIO_GCLK)		(TXD0) GPIO14	08
09	Ground		(RXD0) GPIO15	10
11	GPIO17 (GPIO_GEN0)		(GPIO_GEN1) GPIO18	12
13	GPIO27 (GPIO_GEN2)		Ground	14
15	GPIO22 (GPIO_GEN3)		(GPIO_GEN4) GPIO23	16
17	3.3v DC Power		(GPIO_GEN5) GPIO24	18
19	GPIO10 (SPI_MOSI)		Ground	20
21	GPIO09 (SPI_MISO)		(GPIO_GEN6) GPIO25	22
23	GPIO11 (SPI_CLK)		(SPI_CE0_N) GPIO08	24
25	Ground		(SPI_CE1_N) GPIO07	26
27	ID_SD (I2C ID EEPROM)		(I2C ID EEPROM) ID_SC	28
29	GPIO05		Ground	30
31	GPIO06		GPIO12	32
33	GPIO13		Ground	34
35	GPIO19		GPIO16	36
37	GPIO26		GPIO20	38
39	Ground		GPIO21	40

Beaglebone Black Pinout Diagram

P9			P8		
Function	Physical Pins	Function	Function	Physical Pins	Function
DGND	1 2	DGND	DGND	1 2	DGND
VDD 3.3 V	3 4	VDD 3.3 V	MMCL_DAT6	3 4	MMCL_DAT7
VDD 5V	5 6	VDD 5V	MMCL_DAT2	5 6	MMCL_DAT3
SYS 5V	7 8	SYS 5V	GPIO_66	7 8	GPIO_67
PWR_BUTTON	9 10	SYS_RESET	GPIO_69	9 10	GPIO_68
UART4_RXD	11 12	GPIO_60	GPIO_45	11 12	GPIO_44
UART4_TXD	13 14	EHRPWM1A	EHRPWM2B	13 14	GPIO_26
GPIO_48	15 16	EHRPWM1B	GPIO_47	15 16	GPIO_46
SPI0_CS0	17 18	SPI0_D1	GPIO_27	17 18	GPIO_65
I2C2_SCL	19 20	I2C_SDA	EHRPWM2A	19 20	MMCL_CMD
SPI0_DO	21 22	SPI0_SCLK	MMCL_CLK	21 22	MMCL_DAT5
GPIO_49	23 24	UART1_TXD	MMCL_DAT4	23 24	MMCL_DAT1
GPIO_117	25 26	UART1_RXD	MMCL_DAT0	25 26	GPIO_61
GPIO_115	27 28	SPI1_CS0	LCD_H5VNC	27 28	LCD_PCLK
SPI1_DO	29 30	GPIO_112	LCD_H5VNC	29 30	LCD_AC_BIAS
SPI1_SCLK	31 32	VDD_ADC	LCD_DATA14	31 32	LCD_DATA15
AIN4	33 34	GND_ADC	LCD_DATA13	33 34	LCD_DATA11
AIN6	35 36	AIN5	LCD_DATA12	35 36	LCD_DATA10
AIN2	37 38	AIN3	LCD_DATA8	37 38	LCD_DATA9
AIN0	39 40	AIN1	LCD_DATA6	39 40	LCD_DATA7
GPIO_20	41 42	ECAPWMO	LCD_DATA4	41 42	LCD_DATA5
DGND	43 44	DGND	LCD_DATA2	43 44	LCD_DATA3
DGND	45 46	DGND	LCD_DATA0	45 46	LCD_DATA1

The GPIO pins are in a floating state and you will have to “force” it high (a positive voltage) or low (ground). This is done by connecting a resistor from the GPIO pin to either 3.3V (pulling high) or to ground (pulling low). This can be accomplished through a setting in the FPP GPIO Inputs page or by wiring a resistor in your circuit (**it is not recommended to do both**).

Here are some examples of using an external resistor to pull high or low. If you are using the internal pull up/down resistors then you can eliminate the 3.3K ohm resistor and the connections it makes.

Graphical wiring of external Resistor pulling the GPIO 14 pin high.

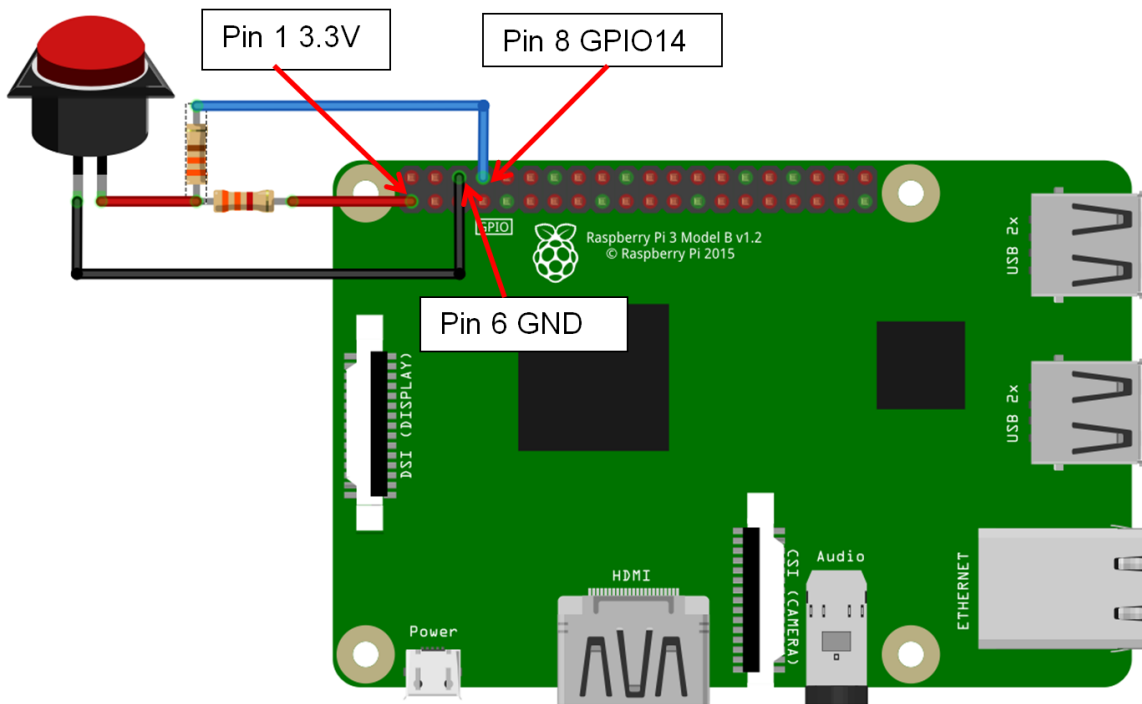

Schematic of external Resistor pulling the GPIO pin high

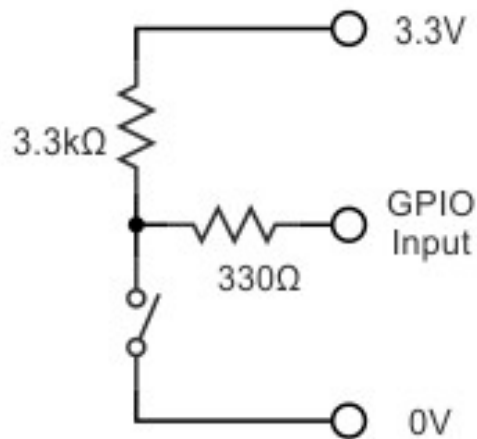

GPIO input is LOW (0)  
when switch is closed

Graphical wiring of external Resistor pulling the GPIO 14 pin low.

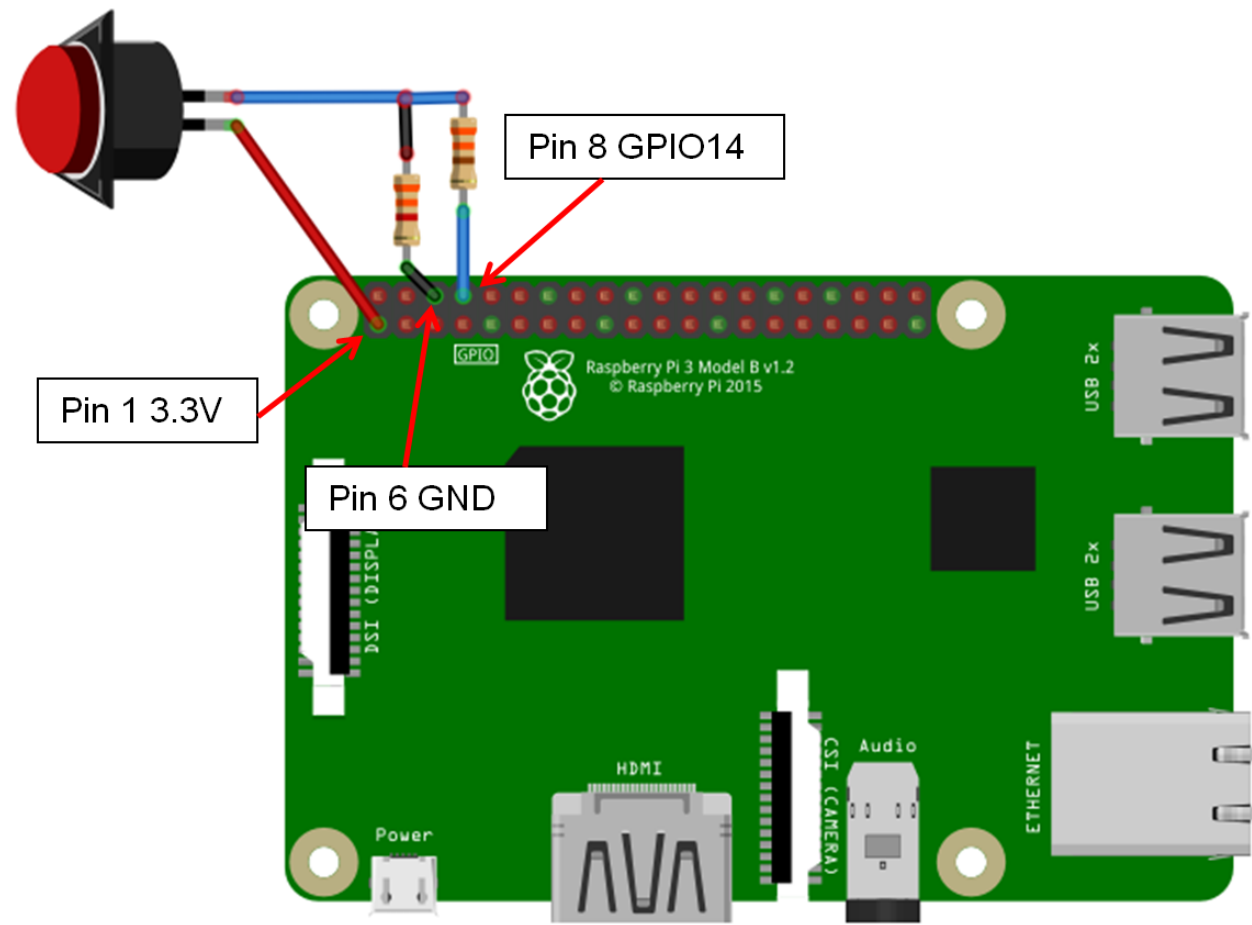

Schematic of external Resistor pulling the GPIO pin low

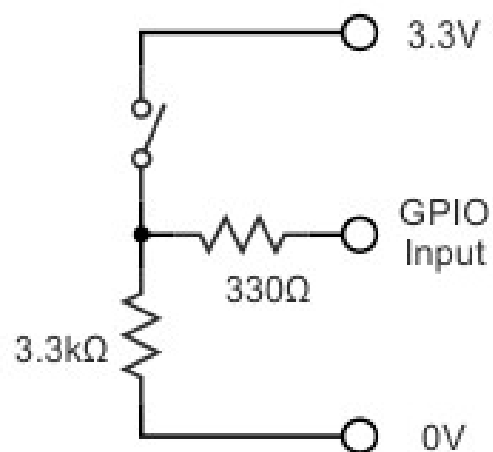

GPIO input is HIGH (1)  
when switch is closed

Graphical wiring of internal Resistor pulling the GPIO 14 pin low\*

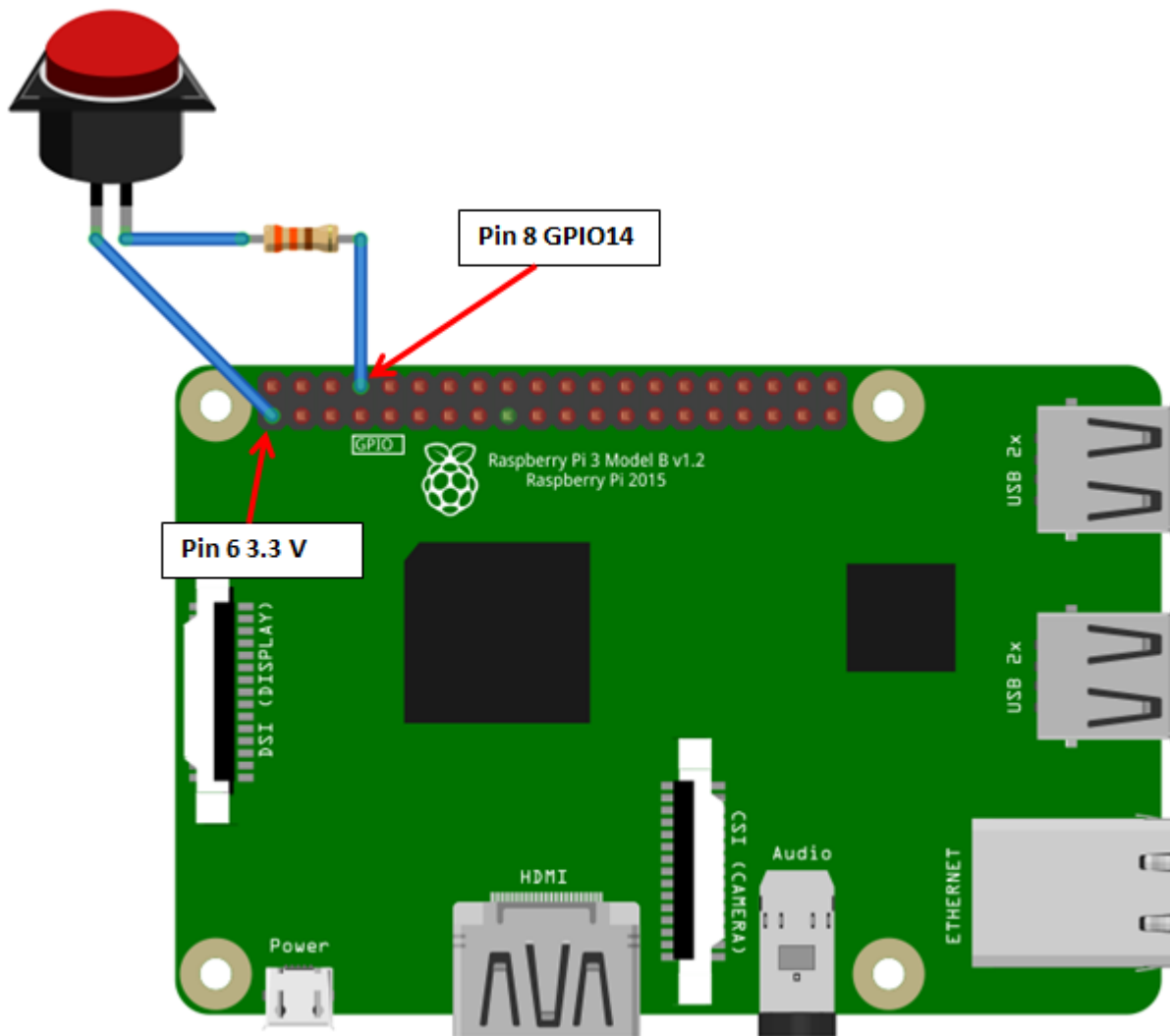

Schematic of Internal Resistor pulling the GPIO pin low\*

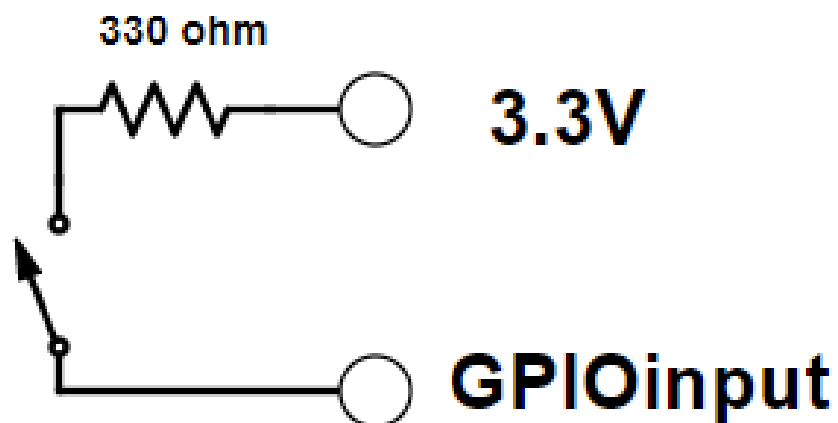



## Graphical wiring of internal Resistor pulling the GPIO 14 pin high\*

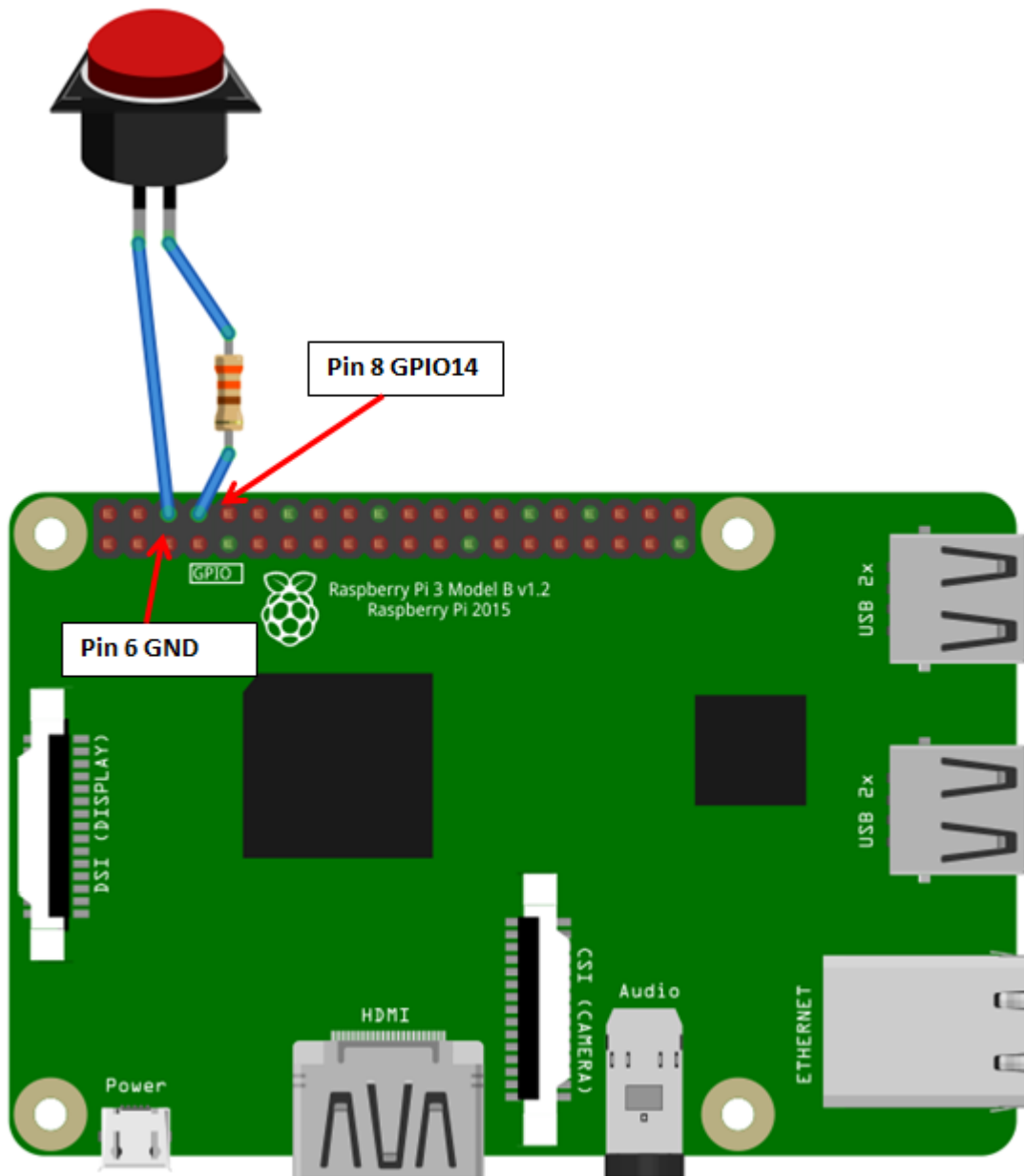

Schematic of Internal Resistor pulling the GPIO pin high\*

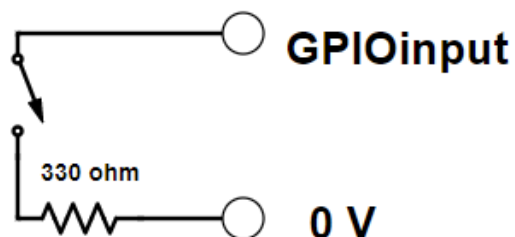

\* This configuration requires that you configure the internal pullup/pulldown resistors appropriately. Refer to the [GPIO Inputs](#) section for more detail.



There are 2 basic types of switches, Normally Open (designated NO) and Normally Closed (designated NC) and you need to know which kind of switch you will be using.

Normally Open- These switches will only let electricity flow through it when it is pressed.

Normally Closed- These switches let electricity flow through it until it is pressed and then the flow is stopped.

The GPIO triggers have two trigger types.

Rising Trigger-This is when the voltage on the GPIO pin transitions from ground to a positive voltage (the exact voltage varies but is around 1.3 v.)

Falling Trigger- This is when the voltage on the GPIO pin transitions from a positive voltage towards ground.

The Event Trigger type (falling or rising) will depend on a few factors such as GPIO pulled high or pulled low, switch is normally open or normally closed, and if you want the trigger to be when the button is pressed or released (you can use both triggers, you just need to identify the actions to take for each trigger)

To clarify this, if you have the GPIO pulled high and have a Normally Open button, then pushing the button will trigger a Falling Event and releasing it will trigger a Rising Event.

## Network Overview

Networks have been troublesome for most of the people getting started in the animated holiday lighting hobby. This is a **very basic overview** and should give you enough information to understand networks and troubleshoot them.

A network is a group of computer devices identified by an IP address. Networks are broken down into groups, typically called subnets. Think of an IP address as a telephone number. In order for devices to be able to communicate with each other, every device needs a “telephone number” (from now on called IP address) and they need to be a unique number. All IP addresses are formatted with 4 groups of numbers, each one separated with a “.” The numbers can only be 0-255. So they would look something like 192.168.110.23 or something similar. The first 3 sets of numbers are like an area code (192.168.110 in 192.168.110.23) and is called a subnet and the last set of numbers is like the “phone” number and is the device number (23 in 192.168.110.23). Only devices on the same subnet (having the same numbers in the first 3 groups) can communicate directly with each other. Any device in your network can communicate **directly** to any other device in your network that is in the same subnet, “area code” just like you can call someone directly by only dialing the 7 digit phone number.

If one device needs to communicate with another device that is on a different subnet, then that is similar to you trying to call someone in a different area/country code. You have to enter some additional “routing” information so the call can be routed to the correct number. When a device on a network receives a request to “call” a device in a different subnet, it does not know how to process the request so it will send the request to a Gateway. A Gateway is similar to an old fashioned operator. The Gateway can be any device that has an IP address but on the same subnet as the device sending the request and the Gateway needs to be able to process the routing of the data. The Gateway is usually your home network router or FPP

device that is between a controller and the show network. The Gateway only has a small “phonebook” to know how to route the traffic. If the Gateway receives an IP address that it doesn’t know how to process, it will forward that request to the Gateway it has designated in its settings. Sometimes special instructions need to be given to the Gateway in order for the signals to get where they need to go and this is commonly done by establishing what is called a Static Route.

You can set up a Static Route on your computer. When you have set up a static route in your computer and your computer is told to send information to an IP address that is in the Static Route table, it will send the data to the Gateway defined for that static route. By having a Static Route set up in your computer, then only that computer will be able to communicate with the device that you are trying to communicate with unless you set up Static Routes on every computer in your network. Most routers will let you set up Static Routes and that way all computers in the local network will have access to the routing information. In Windows, you can set up the route to be persistent, meaning that it will be permanently stored on the computer. Mac computers do not have the persistent ability, so if you turn off or reboot your computer, you will need to add the Static Route again.

## Universes, Channels and Ports, oh my!

**Many people have problems understanding the terminology and usage of channel addressing and ports. The xLights/FPP developers have created methods such as Auto Size, Auto Layout Models, Visualizer and FPP Connect to eliminate the need to understand any of this and is the recommended method to use to configure your controllers and FPP devices.**

A port is just a place to connect your string of pixels. The controller will usually have several ports and the controller needs to know what data to send to each port. Our lighting networks usually have tens of thousands of channels and there needs to be a way to identify where each pixel is located. In other words, all of your devices (and you) need to know where every pixel is, what model it is on, what controller is sending the data for that model and what port(s) are being used to send the data to the pixel strings.

The animated holiday lighting evolved from DMX data and incorporates its protocol to send data and that protocol is Universes and Channels. By definition a Universe can have any number of Channels in it up to a maximum of 512 channels (you are the one who decides how many channels you want your Universes to address).

You can use Absolute Addressing where each pixel is assigned 3 channels and it is basically just a numbering from 1 to however many channels you need but this can sometimes get confusing and difficult to manage. You can break it down into Universes and Channels to help make it easier to manage.

Think of it this way, your lights are a long string of pixels. Let’s correlate the pixels to people. The people have families, some are bigger than others. The families are equivalent to the models in your show. All the families are going to go on a train ride. The train cars only have single file seating so it is one person in front of the other. All the passengers will get a drink while on the train. The drink represents the data sent to your pixels to know what color to create. The travel agent (equivalent to the sequencing software) will create a list of all the passengers and the drink they ordered. The travel agent does not know what size the train

cars are going to be so it will just assign the passengers' seating from front to back and assign their drink order to the position in the list. The train Terminal (equivalent to the controller) will coordinate the passenger seating and drink order with the attendants (the attendants are similar to the ports on your controller). The attendants, for whatever reason (union issues maybe? LOL), do not deliver drinks to the same number of people. The Terminal will know what size each train car is going to be for this trip and how many drinks each attendant will serve. The train car comes in different sizes but the biggest one can hold 512 people. The cars correspond to Universes. So to deliver the correct drink to the correct person, the Terminal will give each attendant the drinks they need in the order of the passengers in their section and tell them where to start serving.

For example, a particular trip will have 1578 people. This particular trip will use cars that hold 512 people, but the cars don't always have to be the same size. The Terminal will assign 4 cars for this trip to hold everyone. Attendant 1 can serve 490 drinks, attendant 2 can serve 560 drinks, attendant 3 can serve 520 drinks and attendant 4 can serve 580 drinks. The Terminal will give the attendant 1 490 drinks in order and tell him to start at car 1 seat 1. The terminal will give the attendant 2 560 drinks in order and tell him to start at car 1 seat 491 (he will have enough drinks to serve the last section of the first car, the entire second car and 26 people in the third car). Then give the attendant 3 520 drinks in order and tell them to start at car 3 seat 27 and give attendant 4 8 drinks in order and tell him to start at car 4 seat 35 (you should be able to do the math to see how this worked).

This is very similar in many ways to how Universe/Channel addressing works. When you are setting up your show, YOU decide how big your Universes are as long as they are no bigger than 512 channels. You can have Universes of different sizes (be careful with this as it might cause confusion).

A few things to note:

- There is no direct correlation between ports on a controller and the Universe/Channel addressing. The port just needs to know which Universe and channel to start on and how many pixels it is sending data to just like the attendant doesn't care how many cars are on the train or how many passengers are on the train. They just need to know which car to get on and which seat to start serving drinks to and when he runs out of drinks, he is done.
- The cars can have an arbitrary number assigned to them, the Terminal can have a number printed on the car and call the first car 100 the second car could be number 215 and as long as the attendants know the car number and what seat to start with, it works. Just like your universes don't have to start at number 1 and don't need to go up sequentially.
- The cars can be any size (up to 512) and not all cars have to be the same size. Again, the ports (attendants) only need to know which car to get on and what seat to start serving drinks.
- A port can supply data to part of a Universe or more than one Universe.
- A port doesn't need to start at the beginning of a Universe or even at the beginning of a model, just like an attendant doesn't need to start at the beginning of a car or beginning of a family. But for management purposes there are some times that you might want to start at the beginning of a Universe or a model. The choice is yours.

# Troubleshooting

In the FPP Status page, there are several warnings that might come up if the FPP device identifies some abnormal conditions. Some of those messages are:

Multiple Frame Skips During Playback – Likely Slow Network.

This indicates that there is something in your network that is slowing down the data, this is usually due to configuring E1.31/DDP outputs on devices that do not need them configured.

Could not resolve Host Name “some name here” – disabling output.- This usually indicates that your DNS server is not configured correctly. The DNS server address needs to be to a device that can actually process DNS requests. Computers and SBC’s do not normally have a DNS server installed but a home router usually does.

Repeated frames taking more than 20ms to send to Colorlite.- This usually indicates a slow network connection to the Colorlite.

Could not create output type “some output type here” Check Logs for details.

Could not initialize output type “some output type here” Check Logs for details.

FSEQ Data Block not available – Likely slow storage.-This is usually due to using a USB drive for storage or a uSD card that is not a Class 10 or higher rated card.

Could not ping DDP/E1.31 Channel Data Target “some IP address”- This is usually due to a controller not being powered on or not configured correctly when the FPP device is configured to output E1.31/DDP data to it.

Received DDP/E1.31 data from “some IP address”- This is usually due to FPP or xLights configured to send E1.31/DDP data to an FPP device that should not normally receive E1.31/DDP data such as an FPP device set in a Master or Remote mode.

Here are a few of the more common problems and their solutions.

Symptom	Possible Causes	Remedy
You can't access the FPP device during the USB Tether installation process.	1. The FPP device doesn't have power.	Make sure that the FPP Device is connected via a USB cable to the computer and the power indicator on the FPP device is illuminated.
	2. (Pi Zeros only) The USB cable is plugged into the wrong port.	The Pi Zero has two USB ports, one is for power only. The correct one is closer to the center of the board and labeled USB and not PWR
	3. The USB cable is faulty.	There are some USB cables that are for charging only. Use another cable that is known to support power and data.
	4. Incorrect IP Address for USB Tethering	When using the USB Tethering method to access your FPP device,

		<p>you can't use the HostName of the device, you have to use the tethering IP address.</p> <p>If you are using a Windows computer, the IP address is 192.168.7.2</p> <p>If you are using a Mac or Linux computer, the IP address is 192.168.6.2</p>
	5. The image on the uSD card is corrupt.	Format and Re-image the uSD card following the procedures in the <a href="#">Installing Software section</a>
	6. The uSD card is faulty.	Format and Re-image a known good uSD card following the procedures in the <a href="#">Installing Software section</a>
	7. The FPP device does not support USB Tethering.	USB Tethering is only supported by Raspberry Pi Zeros and BeagleBone devices.
You can't access the FPP device during the Networked installation process.	1. The FPP device doesn't have power	Check that the power is connected and the power LED is lit on the FPP Device.
	2. The Ethernet cable is faulty.	Test your Ethernet cable or use a known good one.
	3. The Ethernet cable is not fully inserted into the RJ45 jacks	Check that the cables are fully inserted at both ends.
	4. The Ethernet cable is plugged into the wrong port on the router.	Make sure that the cable is inserted into a LAN port and not a WAN port on your router.
	5. The pins in the RJ45 connector are damaged.	Conduct a visual inspection to make sure the pins are not bent or missing.
	6. You are trying to access the FPP device directly.	You do not access the FPP interface directly; you have to connect through a web browser like Google Chrome.
	7. You are using the wrong Host Name.	The correct Host Name for accessing a fresh install is <a href="http://fpp/">http://fpp/</a> or <a href="http://fpp.local/">http://fpp.local/</a> If you have other FPP devices on your network then the Host Name access might not work. Refer to the next item, DNS not resolving local names.
	8. DNS not resolving local names.	Sometimes a router will not resolve DNS host names (like <a href="http://fpp">http://fpp</a> ) so you have to enter the IP address for

		<p>the FPP Device. This entails accessing your router and might be a little technical for some.</p> <p>Log in to your router's administration page (many times the log in information will be on a sticker on the router, if not, look up the default log in for your brand router)</p> <p>Once you log in, there should be a device table or a connected devices section (What it is called depends on the router.)</p> <p>You should see a device labeled FPP, enter the IP address associated with the FPP device.</p>
	9. The FPP device doesn't have a good network connection.	<p>Look in your available networks on your computer and see if there is an entry for FPP, if so, then the FPP device could not communicate with your network. Check all cables.</p> <p>Another issue is that the network you are connecting to is on a 192.168.7.xxx subnet.</p>
	10. The image on the uSD card is corrupt.	<p>Format and Re-image the uSD card following the procedures in the <a href="#">Installing Software section</a></p>
	11. The uSD card is faulty.	<p>Format and Re-image a known good uSD card following the procedures in the <a href="#">Installing Software section</a></p>
You can't access the FPP device during the Wi-Fi Tether installation process.	1. The FPP device doesn't have power	<p>Check that the power is connected and the power LED is lit on the FPP Device.</p>
	2. The FPP device doesn't broadcast the FPP network.	<ol style="list-style-type: none"> <li>1. The FPP device is connected to a network of some kind. Make sure that you do not have the FPP device connected via Ethernet to any device or USB cable to your computer.</li> <li>2. The FPP Device doesn't have a Wi-Fi adapter. Make sure that your FPP device has a Wi-Fi Adapter</li> <li>3. Your Wi-Fi adapter does not support Wi-Fi tethering. Many USB based Wi-Fi adapters do not support Wi-Fi tethering. (on</li> </ol>

	board Wi-Fi adapters on the Raspberry Pi and BB wireless versions supports Wi-Fi tethering)
3. The FPP device broadcasts the FPP network but you cannot connect to the FPP network.	Your Wi-Fi adapter does not support Wi-Fi tethering. Many USB based Wi-Fi adapters do not support Wi-Fi tethering. (on board Wi-Fi adapters on the Raspberry Pi and BB wireless versions supports Wi-Fi tethering)
4. The image on the uSD card is corrupt.	Format and Re-image the uSD card following the procedures in the <a href="#">Installing Software section</a>
5. The uSD card is faulty.	Format and Re-image a known good uSD card following the procedures in the <a href="#">Installing Software section</a>